

# Gerhard Schläger OHG

Landwirtschaftliche Verschleißteile und Werkzeuge

**Etzdorfer Str. 10 - 91327 Gößweinstein**

Tel. 09242/1349 - Fax 09242/586

Öffnungszeiten: Mo-Fr 8.00-12.00 u. 13.00-16.30 Uhr

[www.gerhardschlaeger.de](http://www.gerhardschlaeger.de)

e-mail: [info@gerhardschlaeger.de](mailto:info@gerhardschlaeger.de)

## Preisliste-Verschleißteile Stand 10.06.2026

Mindestbestellwert € 50,00 - Alle Preise inklusive Mehrwertsteuer

aktueller Katalog auf unserer Internetseite [www.gerhardschlaeger.de](http://www.gerhardschlaeger.de)



per LKW € 4,95 - Lieferung innerhalb ca. 8 Tagen

Paketdienst € 4,95 - je Paket bis 30 kg / Lieferung 1-2 Tage



## Aktion Sommer 2026

SEH Original Schumacher SEH			passend für Claas		
Ährenheber	Doppelfinger	Klingen	Ährenheber	Doppelfinger	Doppelfinger
ASL 100 / 120 / 127	Easy Cut	Pro Cut	CM 100	Lexion	neu ohne Steg
je Stück € 20,90	16500.01	fein € 1,30	je Stück € 12,90	626.295.1	0.519.600.0
ab 10 Stück € 19,85	€ 16,90	grob € 1,40	ab 10 Stück € 11,90	€ 13,90	€ 12,20

passend für Köckerling / Pöttinger / Sauerburger / Agri-Farm					
Kultizinken	Kultischar 2 Loch 45mm Lochabstand		Gänsefußschar passend für 504032		
passend für 504008 70x12mm	passend für 504019	passend für 915772	200 x 6 mm	200 x 6 mm	mit Widia
ab 10 Stück	ab 30 Stück	mit Widiaplatte	Aktion	Org. Frank	1,9 kg
Eurozappa € 49,90	300x60x10 mm	300x60x10 mm	ab 30 Stück	ab 30 Stück	€ 79,90
Bellota € 54,90	€ 7,90	€ 42,50	€ 7,90	€ 9,90	

Kompressor Birkenstock 380 Volt Made in Germany		Schleppschuh für Gülleverteiler	
2 Zylinder	2 Zylinder / 2 Stufen Verdichter	passend für Bomech	passend für Fliegl
40 ltr./10bar/500ltr. € 1350,00	90 ltr./10bar/750ltr. € 2180,00	95089	GFZUSG900100
90 ltr./10bar/500ltr. € 1450,00	90 ltr./15bar/750ltr. € 2180,00	Standard € 14,90	
		beschichtet € 29,90	€ 39,90



# Preisliste Sommer 2026







LED-Leuchte FarmTube		LED-Leuchte FarmLine		LED-Leuchte SlimLine	
mit Gehäuse, ammoniakbeständig, dimmbar, Schutz IP69K		mit Gehäuse, besonders geeignet für nasse und feuchte Umgebungen		mit Gehäuse, ideal für niedrige bis mittlere Deckenhöhen Schutz IP66	
					
122 cm / 40 Watt	152 cm / 60 Watt	119 cm / 25 Watt	149 cm / 50 Watt	120 cm / 35 Watt	150 cm / 45 Watt
6000 Lumen	9000 Lumen	3200 Lumen	6400 Lumen	4900 Lumen	6300 Lumen
€ 79,90	€ 89,90	€ 36,90	€ 39,90	€ 34,90	€ 39,90







LED - Leuchte Multi LED			LED - Flutlicht Comfort Pro		
gelb	gelb	grün			
					
150 Watt	225 Watt	300 Watt	5 Jahre Garantie	5 Jahre Garantie	5 Jahre Garantie
19500 Lumen	36000 Lumen	48000 Lumen	50 Watt	100 Watt	200 Watt
€ 159,00	€ 209,00	€ 329,00	6000 Lumen	13000 Lumen	26000 Lumen
			€ 89,00	€ 145,00	€ 229,00







LED - Außenstrahler 230Volt				LED - Akkustrahler	
2 Jahre Garantie				WorkFire 2500	WorkFire 2200
					
<b>Watt</b>	<b>Lumen</b>	<b>Standard</b>	<b>m. Bewegungsmelder</b>	Li-Ion Akku 3 Leuchstufen 20x18x6 cm für den Außenbereich geeignet	Li-Ion Akku 11x11x5 cm mit Magnet, Standfuß und Karabiner
20 Watt	2400 Lu	€ 10,90	€ 21,90	30 Watt / 2500 Lumen	20 Watt / 2200 Lumen
30 Watt	3600 Lu	€ 16,50	€ 25,90	€ 47,90	€ 29,90
50 Watt	6000 Lu	€ 22,90	€ 30,90		
100 Watt	12000 Lu	€ 39,90	/		

LED - Hallenstrahler 230 Volt					
	sehr effizient durch hohe Lichtausbeute nicht für Stallungen geeignet		dimmbar ammoniakbeständig für Stallungen geeignet		GS / DLG geprüft, dimmbar ammoniakbeständig für Stallungen geeignet
3 Jahre Garantie		5 Jahre Garantie		8 Jahre Garantie	
<b>Hi LED Evo</b>		<b>Hi LED Pro</b>		<b>Premium Farmer</b>	
75 Watt	11250 Lumen	€ 66,90	100 Watt	16000 Lumen	€ 96,90
125 Watt	18750 Lumen	€ 83,90	150 Watt	24000 Lumen	€ 115,00
175 Watt	26250 Lumen	€ 109,00	200 Watt	32000 Lumen	€ 139,00
				200 Watt	32000 Lumen € 195,00







LED - Röhren EcoTube Plus / Tageslichtweiß 4000k o. 6500k / extra hohe Lichtleistung			
Eco Tube Plus 120	Eco Tube Plus 150	Feuchtraum Wannenleuchte	Feuchtraumleuchte doppelt
120 cm #345653	150 cm #345652		
3000 Lumen	4000 Lumen	für LED-Röhren ohne Leuchtmittel	inkl. 2x LED-Röhren 22W
18 Watt	24 Watt	120 cm #345670 € 18,50	IP65 / 5900 Lumen / 6500k
1 Stück € 10,90	1 Stück € 11,90	150 cm #34567 € 21,50	150 cm #345672 € 34,90
ab 5 Stück € 9,90	ab 5 Stück € 10,90		

Kratzbürste		Bürste Bully		Bürste Benny	Kratzmatte
	halbrund grün/rote Borsten aus Polyamid		halbrund rot/blau Borsten aus Polyamid		
			sehr robuste Konstruktion  ausgelegt für die Bullenmast	für Rinder, Kälber, Pferde geeignet	für Kälber aus Gummi
50 x 23 x 14 cm	50 x 22 cm € 43,90	90 x 30 cm	€ 179,00	44 x 19 cm	40 x 30 cm € 22,50
<b>Aktion € 29,90</b>	50 x 32 cm € 59,90	Ersatzbürste	€ 36,90	<b>€ 25,90</b>	60 x 40 cm € 36,50

Vihsaugentwöhner Modell Müller			Müller 2010 mit Überwurfschutz		
					
klein weiß	mittel gelb	groß beige	klein rot	mittel orange	groß blau
je Stück € 3,50	je Stück € 3,50	je Stück € 3,50	je Stück € 3,90	je Stück € 3,90	je Stück € 3,90
ab 12 St. € 3,20	ab 12 St. € 3,20	ab 12 St. € 3,20	ab 12 St. € 3,50	ab 12 St. € 3,50	ab 12 St. € 3,50

Kälbertränkeimer mit Ventil			Halter	Sauger 100 mm lang		
			mit Auswurfsicherung 	Latex 	Kautschuk 	Super 
144	transparent	14210 mit	Bucket Guard	# 1454	# 1477	# 147
Standard	weiß/blau/gelb	Hygieneventil	3 Stück Pack.	beige	honig	rot
€ 7,95	€ 9,90	€ 15,90	€ 9,90	je Stück € 0,90	je Stück € 1,00	je Stück € 0,90
				ab 10 St. € 0,85	ab 10 St. € 0,95	ab 10 St. € 0,85
				ab 50 St. € 0,80	ab 50 St. € 0,90	ab 50 St. € 0,80





Rollwatte	Verbandvlies	Fixierbinde	Klauenbandage VETlastic		
					
Rollino	Absorba	elastisch 4 mtr. lang	selbsthaftende elastische Bandage		
8 Stück Pack #16464	#16453	20 Stück Pack	in rot, grün oder blau lieferbar		
10 cm x 3 mtr.	5 mtr. x 10 cm	#16461 8 cm € 7,90	4,5 mtr. x 7,5 cm	4,5 mtr. x 10,0 cm	
€ 13,50	€ 8,20	#16463 10 cm € 9,30	ab 24 Stück € 1,40	ab 18 Stück € 1,80	





Demo-Tec	Holzklötze			Technovit	Technovit-2 Bond
					
Easy Bloc	Standard	XL	Keilform	Standard 6091	Zweikomponenten-Klauenkleber
12 er Pack	112 mm	130 mm	112 mm	10 er pack	Starterset für 10 Anwendungen
mit	#16104	#16105	#16132	ohne Beschleuniger	kpl. mit Pistole #16239 € 75,90
Plastikschuhen	ab	ab	ab	€ 85,90	ohne Pistole #16240 € 49,90
	50 Stück	50 Stück	50 Stück	mit Beschleuniger	Ersatzkartusche #16241 € 25,90
€ 104,90	€ 0,70	€ 1,00	€ 1,00	€ 89,90	Mischkanülen #16243 € 7,90



Euterpapier	Euterholzwolle	Euterhand- sprüher	Eutra-Melkfett	Milchzelltest
1 Pack = 2x200 Blatt  € 5,90	 	Org. Gilmour 		
ab 5 Pack € 5,50 ab 30 Pack € 5,20	12 kg #15821 € 42,50	mit Messingeinsatz € 9,95	Zitzenpflege 5 kg € 39,90	1 ltr. Flasche € 6,20 5 ltr. Kanister € 29,90

## Einmalhandschuhe - Melkhandschuhe

				
Latex gepudert Gr. S,M,L,XL 100 St. € 8,50	Nitrile Top Pro blau Gr. S,M,L,XL,XXL 100 St. € 12,90	Keron Premium Plus Gr. S,M,L,XL,XXL 50 St. € 15,90	Veterinär VETtop armlang Polyethylen 100 St. € 14,50	VETtop armlang mit Schulterchutz 50 St. € 11,90

HSW Ject Eco Einmalspritzen	HSW-Einmalkanülen 100 Stück Packung	Fußfessel Nylon	Tränkebecken Hosp K2
			
2/3ml 100 Stück € 8,90 5/6ml 100 Stück € 9,90 10/12ml 100 Stück € 12,50 20/24ml 100 Stück € 19,50	0,8x40 mm grün € 6,60 1,2x25 mm rosa € 6,60 1,2x40 mm rosa € 6,60 1,6x40 mm weiß € 6,60	Nylon weiß € 6,95 Nylon 1a grün € 12,50 dto. verstellbar € 15,90	Hosp - Allweiler Modell K2 1/2" Anschluss € 87,90

Viehzeichen-		Fesselbänder		
Stifte	Spray 400 ml	Kunststoff	Klettverschluss	Quick Strap
 rot, blau, grün oder schwarz	 rot, blau oder grün	gelb, orange, rot, blau oder grün 	gelb, rot, blau oder grün  oder im Pack farblich sortiert	gelb, rot, blau oder grün 
je Stück € 1,60 ab 10 Stück € 1,50	je Stück € 4,90 ab 5 Stück € 4,60	je Stück € 1,90 ab 10 Stück € 1,80	10 Stück Packung € 6,50	stufenlos verstellbar 5 Stück Pack. € 9,40

Viehtransportstricke				Halsmarkierungsband für Kühe			
	Stück	ab 10 St.			Stück	ab 30 St.	
blau-weiß 12mm / 3,20 mtr	€ 1,70	€ 1,50		weiß Rollschnalle 135 cm 20878	€ 4,50	€ 4,20	
Kälberstricke 8 mm / 1,80 mtr.	€ 1,00	€ 0,90		weiß Ringverschluss 130 cm 2088	€ 3,20	€ 2,90	
Bullenstricke 14 mm / 3,50 mtr.	€ 2,95	€ 2,65		grün Plastikverschluss 130 cm 20923	€ 5,40	€ 4,90	

### passend für Amazone / BBG "C-MIX"



Bild	Bezeichnung	Org. Nr.	€
(1)	Spitze 80x20 mm	78708734	19,90
(2)	Spitze 100x15 mm	78708731	21,50
(3)	Spitze m Widia 80x20 mm	78708804	79,50
(4)	Flügelschar 180x10 mm	78708825 / 26	18,90
(4)	Flügelschar Widia 180x10 mm	78708679 / 830	62,00
(5)	Leitblech R/L 80x12 mm	78708735 / 36	24,50

### passend für Dal-Bo

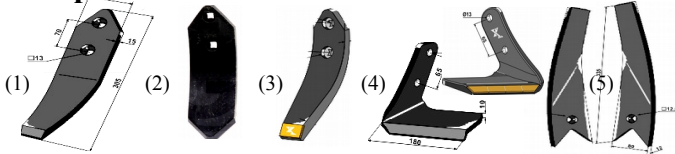

Bild	Bezeichnung	Org. Nr.	€
(1)	Vorschar 120x10 mm	76251	24,90
(2)	Flügelschar 315x10 mm	76253 / 76254	21,50
(3)	Scharfuß	76252	34,50

### passend für Doublet Record



Bild	Bezeichnung	Org. Nr.	€
(1)	Spitze 120x9 mm	0423100	17,90
(2)	Flügel 265x8 mm	0423400/450	18,50
(3)	Leitblech 120x8 mm	0423150	19,90

### passend für EuM Vibrocatt

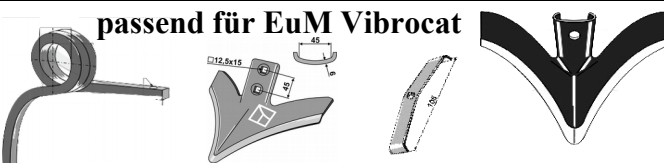

Bezeichnung	€
Gänsefußschar 310x8 mm Lochabstand 45 mm	29,90
Schnellwechscherschar 305x8 mm	49,90
Sicherungsfeder 105 mm	5,95
Grubberstiel 30x30 4kt. gedreht rechts 101.304581	82,50
Grubberstiel 30x30 4kt. gedreht links 101.304591	82,50

### passend für Farnet Duolent Triolent Turbolent



Bild	Bezeichnung	Org. Nr.	€
(1)	Spitze 75x12 mm	3002317	12,95
(2)	Spitze Widia 75x25 mm	4005271	49,90
(3)	Spitze Widia 40x28 mm	4007998	32,50
(4)	Flügelschar 200x10 mm	3003266 / 67	18,50
(4)	Flügelschar 135x10 mm	3003294 / 95	18,90
(4)	Flügelschar 110x10 mm	3002403 / 04	18,90
(5)	Leitblech 75x12 mm	3002413	26,90

### passend für Gebo - Knoche

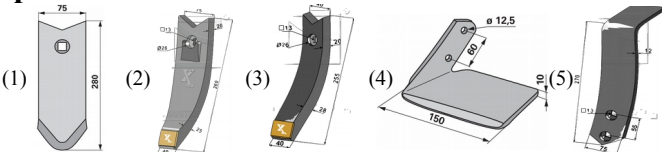
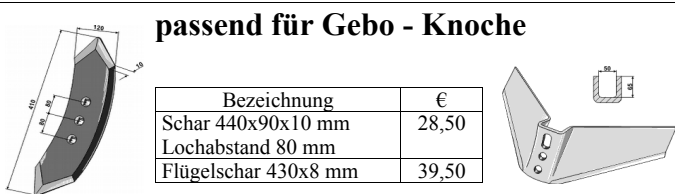

Bezeichnung	€
Schar 440x90x10 mm Lochabstand 80 mm	28,50
Flügelschar 430x8 mm	39,50

### passend für Horsch



Bild	Bezeichnung	Org. Nr.		Nachbau	Frank
(1)	Spitze 80x12mm	34060850	Standard	9,90	
(1)	Spitze 80x15mm	34060850	verstärkt	13,90	15,90
(1)	Spitze 80x12mm	34060850	beschichtet	22,90	
(1)	Spitze 80x15mm	34060850	beschichtet	29,50	
(2)	Spitze 80x15mm	00310915	1x Widiaplatte	38,90	38,90
(3)	Spitze 80x15mm	00310915	beschichtet		33,50
(4)	Spitze 80x28mm	00311069	3x Widiaplatte	69,50	Mölbrot
(5)	Bundmutter M12	00350084	Güte 10.9	0,70	
(6a)	Schmalschar 1 x Widia	00311114	500x40x20 mm	44,50	
(6a)	beschichtet / 1 x Widia	00311114	500x40x20 mm	59,00	
(6b)	Schmalschar 8 x Widia	00311114	500x40x20 mm	129,00	
(6c)	Gänsefußschar	00310225	305x6 mm	29,90	LA 57
(6d)	Gänsefußschar Cruiser	Aktion	180x6 mm	9,80	LA 43
(6d)	Gänsefußschar Cruiser	00311511	200x6 mm	15,90	LA 43
(6e)	Schmalschar Cruiser	00311102	50x12 mm	12,90	
(6f)	Schmalschar Cruiser	00311565	Widiaplatte	69,90	
(6g)	Gänsefußschar Finer	60036759	225x8 mm	23,90	LA 45



Bild	Bezeichnung	Org. Nr.		Nachbau	Frank
(7)	Flügel 4 Loch kurz	00311326/27	107x10 mm	15,90	
(7)	Flügel 4 Loch	00311328/29	Standard	15,90	16,90
(7)	Flügel 4 Loch	00311328/29	beschichtet	24,90	
(7)	Flügel 4 Loch	00311274/75	Widiaplatte	77,50	79,90
(8)	Flügel 2 Loch	34060856/57	Standard	14,50	16,90
(8)	Flügel 2 Loch	34060856/57	beschichtet	23,90	
(9)	Flügel 2 Loch	34060856/57	Widiaplatte	72,50	79,90

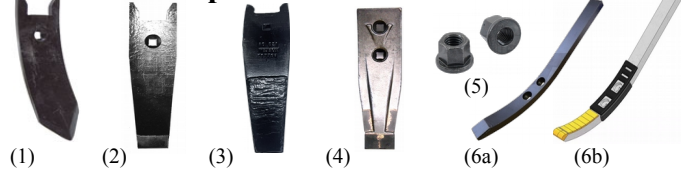

Bild	Bezeichnung	Org. Nr.		Nachbau	Frank
(10)	Leitblech L/R	34060858/59	8 mm	14,90	16,90
(10)	Leitblech L/R verst.	34060858/59	10 mm	19,90	
(11)	Randleitblech	34182600/70	links / rechts	22,90	26,90
(12)	Grubberstiel	34060835	EBH 560 mm	89,00	
(12)	Grubberstiel	34060836	EBH 650 mm	95,00	

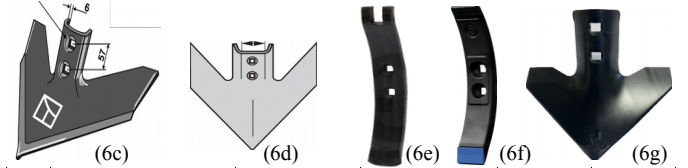

Bild	Bezeichnung	Org. Nr.		€	
(13)	Verschleißplatte	34265006	45x10 mm	7,90	
(14)	Zwischenfeder	34283704	60x 9 mm	28,90	1 Loch
(14)	Zwischenfeder	00330109	60x 9 mm	28,90	2 Loch
(15)	Packerfeder	00330141	60x 9 mm	20,50	LA 40
(15)	Packerfeder	00330142	70x 9 mm	21,50	LA 40
(15)	Packerfeder	00330198	70x10 mm	25,80	LA 70

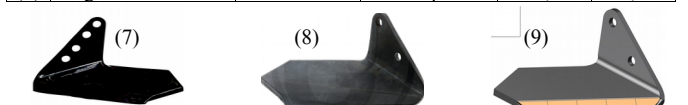

Bild	Bezeichnung	Org. Nr.		€	
(16)	Striegelzinken	00310081	480x12 mm	8,90	
(17)	Striegelzinken dopp.	00430507	450x12 mm	12,50	
(18)	Striegelzinken	23250303	380x12 mm	8,50	145mm br.
(19)	Striegelzinken	34217502	530x12 mm	18,50	
(20)	Flanschlager	00240028	Ø 40 mm	67,90	
(21)	Schneide Rollcut	34286011	450mm	29,90	6mm stark

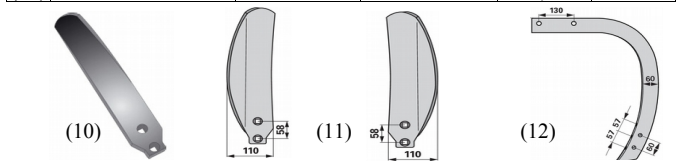

## passend für Kerner Galaxis / Komet / Corona

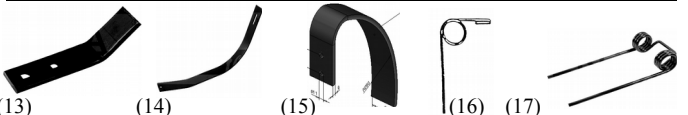
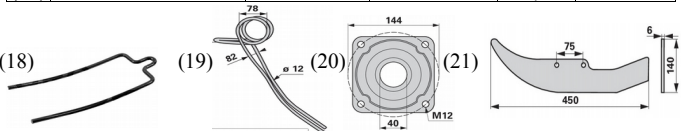

Bild	Bezeichnung	Org. Nr.		€
(1)	Spitze 120x12 mm	92281	verstärkte Ausführung	14,90
(1)	Spitze 120x12 mm	92282	beschichtet	24,90
(2)	Spitze 100x12 mm	92229	schmale Ausführung	14,50
(2)	Spitze 100x12 mm	92344	schmal beschichtet	33,50
(3)	Spitze 100x20 mm	92229	3 x Widiaplatte	89,00
(4)	Spitze 80x14 mm	92230	extra schmal	15,90
(4)	Spitze 80x14 mm	92236	extra schmal beschichtet	36,90



Bild	Bezeichnung	Org. Nr.		€
(5)	Flügelschar	92275	480x10 mm	59,50
(6)	Flügelschar	92276	450x10 mm	55,90
(7)	Flügelschar	93809	350x10 mm	64,90

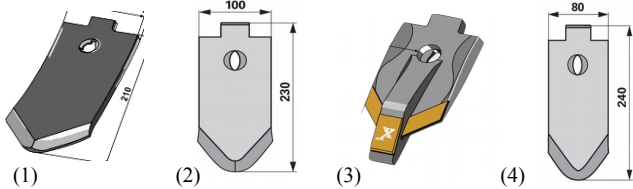

Bild	Bezeichnung	Org. Nr.		€
(8)	Flügel pass. für Komet	10-005.300	beschichtet	98,00
(9)	Flügel pass. für Corona	007647	320x10 mm	46,50
(9)	Flügel pass. für Corona	007647	beschichtet	98,00

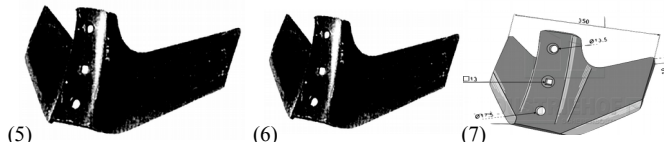

Bild	Bezeichnung	Org. Nr.		€
(10)	Leitblech Standard	92274	100 mm breit	13,50
(11)	Leitblech schmal	92345	80 mm breit	13,50
(12)	Leitblech mit Nut	92347	80 mm breit	25,90
(13)	Leitblech schmal links	10-005.125	80 mm breit	24,90
(14)	Leitblech schmal rechts	10-005.126	80 mm breit	24,90



Bild	Bezeichnung	Org. Nr.		€
(15)	Spitze 120x12 mm	verstärkt	Doppelkerbe 12 Ø Loch	19,50
(16)	Flügelschar Winkel 25°	Standard	480x 8 mm	49,50
(16)	Flügelschar Winkel 25°	verstärkt	480x12 mm	59,00
(17)	Leitblech	02-005.700	100x 8 mm	14,90

## passend für Unia

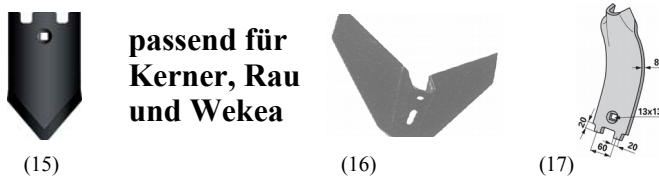

Bild	Bezeichnung	€	Bild	Bezeichnung	€
(1)	Spitze 120x12 mm	14,50		neue Ausführung	
(2)	Flügel 350x 8 mm	12,90	(4)	Spitze 2111 20-0020	15,50
(3)	Leitblech 270x 8 mm	10,50	(5)	Flügel 2111 20-1010	14,90

## passend für Kongskilde



Bild	Bezeichnung	Org. Nr.	Delta Flex	€
(1)	Scharspitze 80x12 mm	101003120	Standard	19,90
(2)	Scharspitze 80x12 mm	101003120	beschichtet	36,90
(3)	Flügelschar 180x10 mm	7204027031/32	links / rechts	22,50
(4)	Leitblech 80x10 mm	101003121	gerade	18,90
(5)	Randleitblech	7204027028/29	links / rechts	49,50

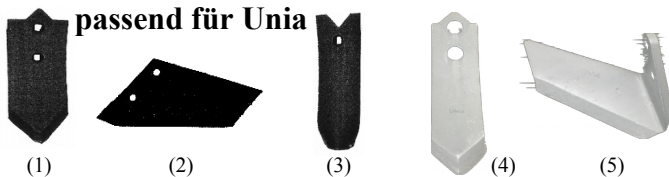

Bild	Bezeichnung	Org. Nr.	Lochabstand	€
(6)	Grubberschar 110x8 mm	101155537	45 mm	16,90
(7)	Gänsefußschar 250x8 mm	101155542	45 mm	24,50
(8)	Flügelschar 285x6 mm	105000649	45 mm	24,50
(9)	Grubberschar 80x8 mm	105000650	45 mm	16,90

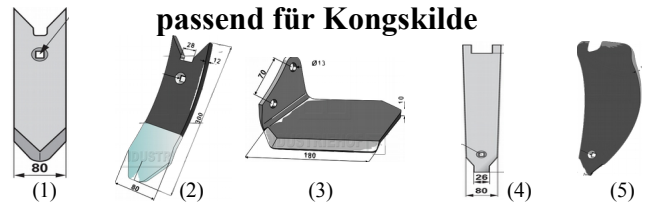

Bild	Bezeichnung	Org. Nr.		€
(10)	Blattfederzinken 150x10 mm	101155033	Vibro Flex	189,00
(11)	Oberfeder 150x10 mm			109,00
(12)	Unterteil	05000128	500 mm lang	53,00
(10)	Blattfederzinken 150x12 mm	101155044	Vibro Flex	198,00
(11)	Oberfeder lose 150x12 mm	05150055		139,00
(12)	Unterteil lose	101155061	600 mm lang	85,00

## passend für Kuhn

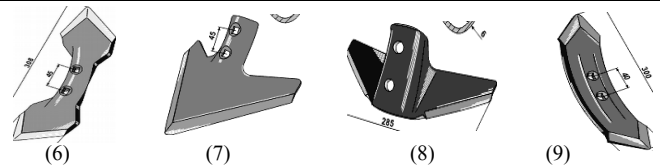

Bild	Bezeichnung	Org. Nr.	€
(1)	Spitze Standard 80x12 mm	H2212540	15,90
(1)	Spitze beschichtet 80x12 mm		26,90
(2)	Spitze mit Widia 80x20 mm	H2217920 / H 2220760	62,50
(3a)	Flügelschar 235x10 mm	H2212500 / H2212510	21,90
(3b)	Flügelschar Frank langer Hals	H2212501 / H2212511	21,90
(3a)	Flügelschar Widia 235x10 mm	H2212501 / H2212511	66,50
(4)	Leitblech li./re. 80x 8 mm	H2212680 / H2212690	19,50
	Leitblech 50x 8 mm	H2225660	15,90
(5)	Gänsefußschar 350x10 mm	H2212550	59,00

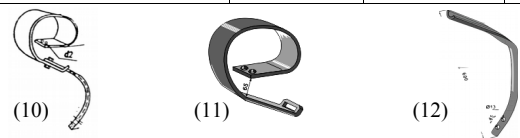
## passend für Kverneland



Bild	Bezeichnung	Lochabstand	Org. Nr.	€
(1)	Vorschar 65x8 mm	40 - 55 mm	KK193570	14,90
(2)	Flügelschar 250x6 mm	40 - 55 mm	KK193617	34,50
(3)	Flügelschar 300x6 mm	45 - 75 mm		34,90
(4)	Ersatzflügel 380x8 mm	75 + 125 mm	131124/25	15,90



Bild	Bezeichnung	Lochabstand	Org. Nr.	€
(5)	Spitze verstärkt 15 mm	40 mm	53090/63090	8,90
(6)	Flügelschar 300x 6 mm	40 + 60 mm	KK301123	24,90
(7)	Leitblech 65x 8 mm	40 + 60 mm	KK301011	23,50
(8)	Gänsefußschar 180x 6 mm	45 - 60 mm	KK193569	23,90
(9)	Meißelschar 440x60x20 mm	60 mm	KK303107	33,50

## passend für Köckerling / Mandam / Maschio

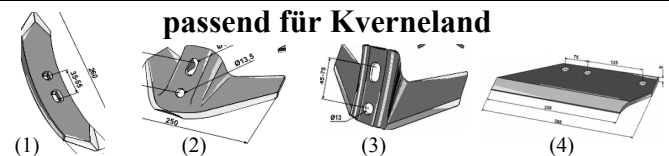

Bild	Bezeichnung	Org. Nr.		€
(1)	Spitze Standard schmal	506065	285x 80x14 mm	11,90
(1)	Spitze beschichtet	506069	285x 80x14 mm	28,50
(2)	Spitze Standard breit	506014	285x100x12 mm	17,90
(3)	Spitze mit 1 Widiaplatte und beschichtet	506065	350x 80x20 mm	63,90
(4)	Spitze mit 3 Widiaplatten	915776	350x 80x30 mm	74,50
(5)	Gänsefußschar	506055	320x10 mm	52,50
(6)	Schmalschar beschichtet und 2 x Widiaplatte Frank	506068	600x 40x20 mm Lochabstand 110 mm	79,90

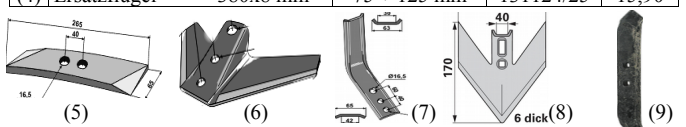

Bild	Bezeichnung	Org. Nr.		€
(7)	Flügelschar Öffnung 25 mm	506025	350x10 mm	44,50
(7)	dto. beschichtet Öffnung 25 mm	506025	350x10 mm	59,90
(8)	Flügelschar neu Öffnung 30 mm	664430	350x10 mm	44,50
(9a)	Flügelschar mit Widiaplatten	506025	350x10 mm	139,00
(9b)	Flügelschar mit Widia 2-tlg.	932214/216	170x10 mm	139,00
(9b)	dto. mit flacheren Eingriffswinkel	939370/372	170x10 mm	119,00

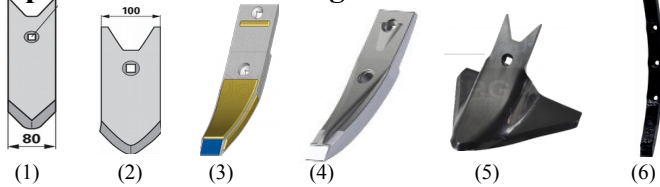

Bild	Bezeichnung	Org. Nr.		€
(10)	Grubberstiel für Topmix	506048	735x25 mm	92,00
(11)	Leitblech gerade	506046	425x80x8 mm	14,50
(12)	Leitblech links / rechts	506000/1	420x80x8 mm	14,90
(13)	Leitblech links / rechts oder gerade	Org. Frank mit Öse		22,90

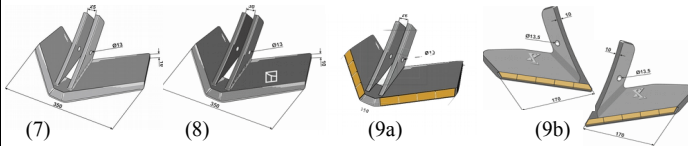

Bild	Bezeichnung	Org. Nr.		€
(14)	Grubberschar	506033	450x100x12 mm	21,90
(15)	Schmalschar Fabr. iQ	506008	470x 60x16 mm	16,90
(15)	beschichtet Fabr. iQ	506006	470x 60x16 mm	27,50
(15)	beschichtet Fabr. Frank	506006	470x 60x16 mm	39,90
(16)	Flügelschar	10003431	480x8mm / 25 °	49,50
(17)	Gänsefußschar 3,0 kg	504018	420 mm / LA 70 mm	49,90
(17b)	Gänsefußschar Widia	937658	220 mm / LA 70 mm	106,90
(18)	Gänsefußschar 5,3 kg	900863	450 x 8 mm	54,00

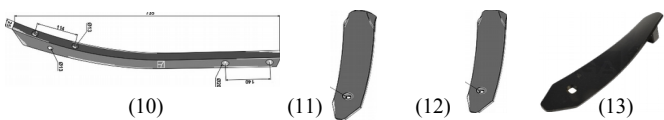

Bild	Bezeichnung	Org. Nr.		€
(19)	Nivelatorzinken 904342	904344	70x12mm / 430 mm lg.	78,50
(20)	Verschleißteil 633928	633930	300x70x8 mm	33,90
(21)	Levelboardzinken	900944	45x10 mm	24,50
(22)	Levelboardzinken	903476	80x10 mm	43,50
(23)	Verschleißteil	905238	450x80x 8 mm	17,50
(24)	Zwischenfeder	904478	645x45x10 mm	26,90
(25)	Verschleißteil f. dto.	633238	540x50x10 mm	26,90

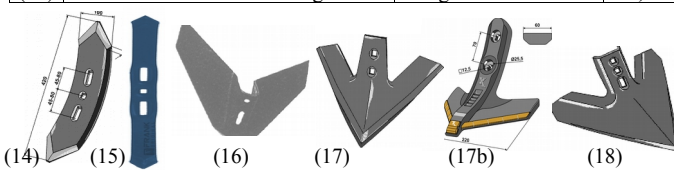

Bild	Bezeichnung	Org. Nr.		€
(26)	Blattfederzinken Vario kpl.	945 mm hoch	150 x 16 mm	299,00
(27)	Oberfeder lose	506207	150 x 16 mm	189,00
(28)	Unterteil 650 mm hoch	506211	50 x 26 mm	89,50

## passend für Lemken Karat + Kristall

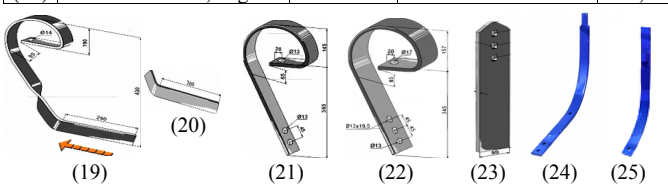

Bild	Bezeichnung	Org. Nr.		Nachbau	Frank
(1)	Spitze 80x15 mm	3374441	beschichtet	26,90	26,90
(2)	Spitze 80x20 mm	3374441	1 x Widiaplatte	49,90	
(3a)	Spitze 80x20 mm	33710031	3 x Widia	69,90	
(3b)	Spitze 80x20 mm	33710031	Widia schwer		89,90
(4)	Spitze 120x10 mm	3374442	Standard	14,90	
(4)	Spitze 120x12 mm	3374443	beschichtet	26,90	29,50
(5)	Spitze 120x26 mm	3374443	Widiaplatte	89,00	
(6)	Randspitze	3374444/45	beschichtet	59,00	
(7)	Flügel 230x10 mm	3374460/61	Karat	17,90	14,90
(7)	Flügel 230x10 mm	3374462/63	beschichtet	25,90	25,90
(8)	Flügel 230x10 mm	3374462/63	Widiaplatte	62,00	
(7)	Flügel 340x10 mm	3374530/31	Kristall	33,90	
(7)	Flügel 340x10 mm	3374532/33	beschichtet	59,50	
(7)	Flügel 370x10 mm	3374536/37	Kristall	36,90	
(7)	Flügel 400x10 mm	3374540/41	Kristall	39,50	
(7)	Flügel 400x10 mm	3374542/43	beschichtet	59,90	
(9)	Leitblech 80 mm	3374482	schmale Ausf.	15,90	11,50
(10)	Leitblech 100 mm	3374484	breite Ausf.	18,90	13,90
(11)	Randleitblech	3374490/91	R/L	18,90	
(12)	Schmalschar	33710006	590x60x25	49,90	
(13)	Schmalschar	33710006	Widiaplatte	74,50	
(14)	Gänsefußschar	33710066	350x10	54,90	DeltaCut

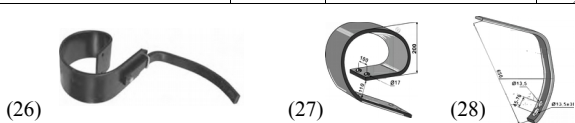

## passend für Lemken Smaragd + Thorit

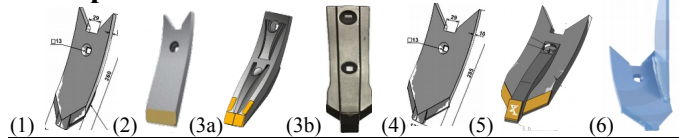
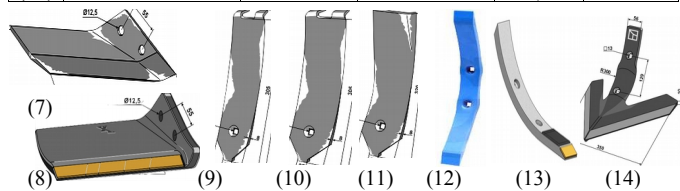

Bild	Bezeichnung	Org. Nr.		Nachbau	Frank
(1)	Spitze 120x10mm	3374388	Standard	11,20	11,90
(1)	Spitze 120x12mm	3374388	verstärkt	11,90	14,50
(1)	Spitze 120x15mm	3374388	verstärkt	18,90	
(1)	Spitze 120x12mm	3374392C	beschichtet	28,90	31,50
(1)	Spitze 120x15mm	3374392C-15	beschichtet	38,50	
(2)	Spitze 120x18mm	3374392	Widia	89,00	
(3)	Spitze 80x15mm	3374386	beschichtet	27,90	33,50
(3b)	Schmalschar 60x20mm	3375420	Widia	79,90	



Bild	Bezeichnung	Org. Nr.		Nachbau	Frank
(4)	Flügel 10mm gerade	3374416/17	340mm lg.	14,90	15,90
(5)	Flügel 10mm gekr.	3374418/19	345mm lg.	15,90	15,90
(5)	Flügel 11mm gekr.	3374420/21	380mm lg.	15,90	16,90
(5)	Flügel 12mm gekr.	3374420/21	verstärkt	16,90	
(5)	Flügel 11mm gekr.	3374424/25	beschichtet	34,90	38,50
(6)	Flügel 12mm gekr.	3374428/29	für Thorit	18,90	15,50

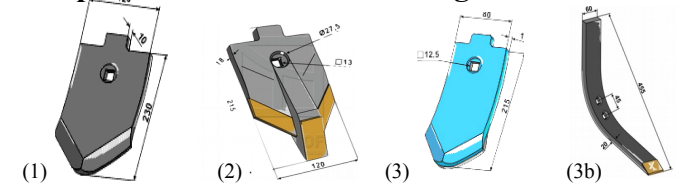

Bild	Bezeichnung	Org. Nr.		Nachbau	Frank
(7)	Leitblech LB1/ 8mm	3374395	100mm br.	11,50	11,50
(7)	Leitblech LB1/10mm	3374395	verstärkt	14,90	
(7)	Leitblech Thorit	3374401	80mm br.	14,50	14,50
(8)	Randleitblech	3374398/99	rechts / links	22,90	24,90
(9)	Scharfuß	4679105	=4679106	24,90	30,90
(10)	Grubberstiel 70x22	4653680	880mm lg.	89,50	99,00

## Schleppzinken - Striegelzinken für Grubber

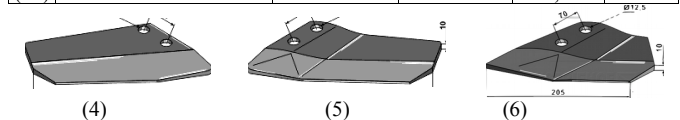

Form	passend für		€
(1)	Schleppzinken gedreht Universal	32x10 / 380 mm lg.	31,50
(1)	Schleppzinken gedreht Universal	60x10 / 430 mm lg.	72,50
(1)	Schleppzinken pass. f. Köckerling	70x12 / 430 mm lg.	78,50
(2)	Striegelzinken 1000 STE	480x12 mm einfach	8,90
(3)	Striegelzinken 1000 STD	560x12 mm doppelt	17,90
	Güttler 72000110	480x12 mm einfach	11,90
(2)	Horsch 0310081	480x12 mm einfach	8,90
(4)	Horsch 430507	450x12 mm doppelt	18,50
	Horsch 23250303	380x12 mm doppelt	9,80
	Horsch 34217502	530x12 mm doppelt	18,50
(2)	Köckerling 501131	515x13 mm einfach	9,90
(5)	Köckerling 501132	635x13 mm einfach	11,90
	Köckerling 900848	760x14 mm einfach	28,90
(5)	Köckerling 905380	735x13 mm einfach	13,90
(6)	Kuhn 951699	490x10 mm einfach	12,50
	Kverneland AC431802/803 L/R	530x10 mm einfach	7,70
(5)	Kverneland 199780-4	620x12 mm einfach	11,90
	Lemken 3538802	550x14 mm doppelt	10,90
(2)	Väderstad 400975	480x12 mm einfach	8,90
(6)	Väderstad 306239	550x12 mm einfach	8,90
(7)	Väderstad 445067	440x12 mm doppelt	17,90

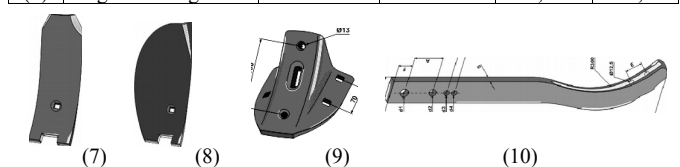
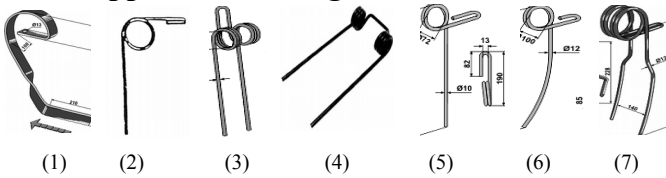

(8)	Halter für Striegelzinken 10.ST-HH12	Rahmen 40x40mm	3,95
(9)	Halter für Striegelzinken 10.ST-HH19	Rahmen 60x60mm	5,90

## passend für Maschio Tiefenlockerer Attila / Pinocchio / Artiglio / Magnum



Bild	Bezeichnung	Org. Nr.	€
(1)	Standard Org. Aufnahme 32 mm	R17220370	87,50
(2)	mit Widiplatte 450x70x38 mm	R17623310	139,00
(1)	Standard Original Aufnahme 37 mm	R17622990	89,00
(2)	mit Widiplatte 450x70x38 mm	R17622960	139,00
	Spannstift f. dto. 13x55 mm	R02100194	1,20
(5)	Flügelschar 209x80x10 mm	R17820860 / 870	12,90
(5)	Flügelschar 209x80x10 mm	beschichtet	36,50
(4)	Schollenbrecher	R17820413	58,00
(4)	Schollenbrecher	R17820063	74,90

## Ersatzflügel passend für Rabe / Rau / Frost



Bild	Bezeichnung	Lochabstand	€
(1)	Frank/Rau 92520 / 92521 Länge 190 mm	50 mm	10,90
(1)	Frank/Rau 92536 / 92537 Länge 250 mm	50 mm	10,90
(2)	Flügelschar komplett 370 mm breit	45-75 mm	42,50
(2)	Flügelschar komplett 430 mm breit	45-75 mm	42,50
(3)	Frost 51749 / 51750 neue Ausführung	78 mm	19,50
(4)	Landsberg 939.50.220.1/221.1	75 mm	12,50
(5)	Rabe GG 45 Standard gerade 8 mm	60 mm	11,90
(5)	Rabe GG 45 verstärkte Ausführung 10 mm	60 mm	16,90
(6)	Rabe GG 51 gekröpft	75 mm	12,95
(7)	Rabe 63443306 Scharfuß	60 + 75 mm	115,00

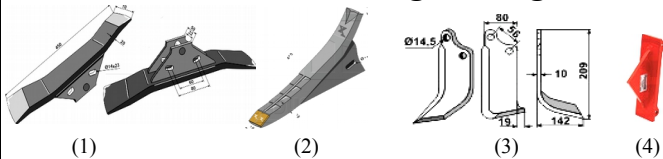
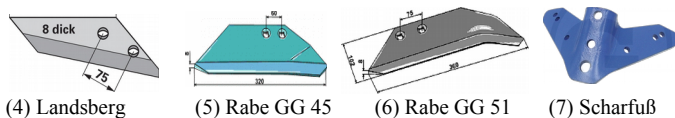

## passend für Pöttinger



Bild	Bezeichnung	Org. Nr.	Standard	beschichtet
(1)	Spitze	9762.50.015.1	13,90	27,90
(2)	Spitze 1 x Widia	9762.50.027.0	44,50	1 x Widia
(3)	Spitze 3 x Widia	9791.50.031.0	74,50	3 x Widia
(4)	Schmalschar 450x40 mm	9791.50.070.0	71,90	1 x Widia



Bild	Bezeichnung	Org. Nr.	Standard	beschichtet
(5)	Flügelschar 170 mm	9762.50.020.1/030.1	14,90	
	Flügelschar 215 mm	9762.50.020.2/030.2	19,80	31,90
(6)	mit Widia 170 mm	9762.50.023.0/024.0	64,50	
(7)	Flügelschar 257 mm	9781.50.020.1/030.1	24,90	
(8)	Leitblech R/L	9762.50.036.0/037.0	12,50	
(9)	Randleitblech	9791.50.038.0/039.0	19,90	

## passend für Landsberg / Pöttinger

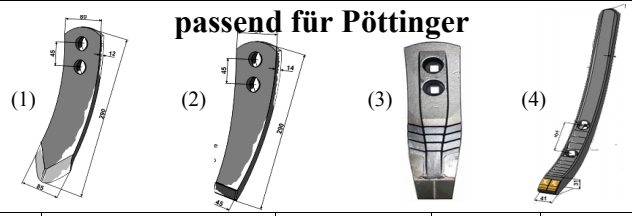

Bild	Bezeichnung	Org. Nr.		€
(10)	Grubberschar	965.50.065.0	390x100x12 mm	21,90
(11)	Flügelschar	966.50.020.0/030.0	Lochabstand 70 mm	18,90
(12)	Scharfuß Orig.	965.50.045.0	Lochabstand 80 mm	119,00
(13)	Randschar	965.50.066.1/067.1	Lochabstand 80 mm	28,50

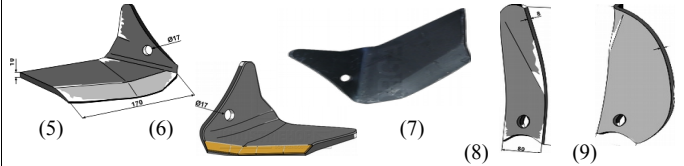
## passend für Väderstad Cultus / TopDown



Bild	Bezeichnung	Org. Nr.	€
(1)	Spitze gerade 50x15 mm	488441 / 155912	15,50
(2)	Spitze gerade 80x15 mm	489233 / 155913	17,90
(3)	Spitze 80x15 mm	155028	17,90
(4)	Spitze 50x15 mm	188623	17,90
(5)	Spitze Widia 80x25 mm	205006	79,90
(6)	Schmalschar 50x20 mm	447152	28,50

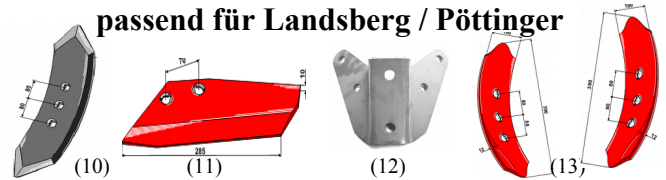

(7)	Gänsefußschar 240x 8 mm	165038	23,90
(8)	Flügelschar 205x10 mm	447150 / 447151	16,50
(9)	Leitblech mitte	461309F	15,90
(10)	Leitblech R/L 80x10 mm	452956 / 452957	13,90
(11)	Randleitblech 80x10 mm	452958 / 452959	25,90

## passend für Vogel & Noot

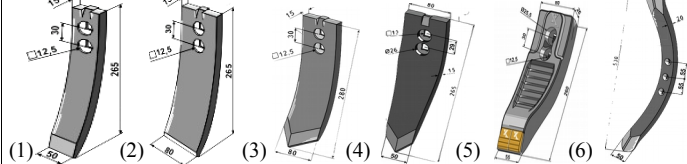
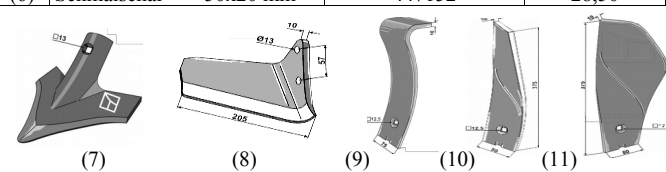

(1)	Vorschär CV 008002	28,50	(3)	MultiQuick System	€
(2)	270x10 mm CV 008008	39,50	(3)	Spitze G0 350700	39,50
(2)	330x10 mm CV 008007	43,50	(4)	Leitblech G0 350001	32,50
(2)	480x10 mm CV 008005	49,50	(5)	Flügel G0 350005	99,50



### Grubberschare

bitte Lochabstand angeben

Bild	Bezeichnung	Maße	Lochabstand	€	
(1)	Doppelherzschar	BPT	440x130 mm	45 oder 70	12,90
(1)	Doppelherzschar	Härte 500	440x130 mm	45 oder 70	17,90
(2)	Breitschar	BPT	440x180 mm	45 oder 70	21,90
(3)	Doppelherzschar	beschichtet	130mm / 5,2 kg	45 oder 70	54,90
(4)	Doppelherzschar	beschichtet	180mm / 6,5 kg	45 oder 70	59,90

### Vorschare passend für

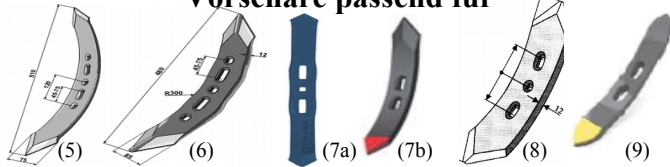

(5)	Amazone gedreht	5 Loch	510x 75x10 mm	Langloch	19,90
(5)	Amazone gedreht	5 Loch	510x 75x12 mm	Langloch	25,90
(6)	Amazone gerade	5 Loch	490x 75x12 mm	Langloch	25,90
(7a)	Schmalschar Frank	3 Loch	470x 50x20 mm	Langloch	28,50
(7a)	Schmalschar IQ	3 Loch	470x 60x16 mm	Langloch	16,90
(7a)	Schmalschar Frank	3 Loch	470x 60x16 mm	Langloch	25,90
(7a)	Schmalschar	beschichtet	470x 60x16 mm	Langloch	27,90
(7a)	Schmalschar Frank	beschichtet	470x 60x16 mm	Langloch	39,90
(7b)	Schmalschar	2 Loch	400x 70x19 mm	45 - 75 mm	24,50
(8)	Vorschär	3 Loch	420x 80x12 mm	Langloch	26,50
(8)	Vorschär	3 Loch	450x100x12 mm	Langloch	21,90
(8)	Vorschär	3 Loch	450x120x10 mm	Langloch	24,90
(9)	Grubberschar	Widiaplatte	360x 50x20 mm	40 - 85 mm	59,50
(9)	Grubberschar	Widiaplatte	360x 60x20 mm	40 - 85 mm	69,50

### Flügelshare Universal

Bezeichnung	Maße	Lochabstand	€
Flügelshar	330x10 mm	45 - 75 mm	43,50
Flügelshar	480x 8 mm	45 - 75 mm	49,50
Flügelshar	480x10 mm	45 - 75 mm	49,50
Flügelshar	480x12 mm	45 - 75 mm	59,00



### Grubberzinken ohne Schar



Bild	Bezeichnung	€
(1)	Grubberstiel 720x60x25 mm / Loch oben 17 mm / LA45 u. 70	65,90
(1)	Grubberstiel 830x60x25 mm / Loch oben 21 mm / LA45	79,00
(2)	Halteplatten - Satz (= 1Paar) 100er Rahmen	59,00
(3)	Grubberstiel 30 / 4kant gedreht / links oder rechts / LA45mm	87,50
(3)	Grubberstiel 35 / 4kant gedreht / links oder rechts / LA75mm	124,00
(4)	Oberfeder 150/14 für Köckerling	169,00
(4)	Oberfeder 150/16 für Köckerling	189,00
(5)	Blattfederzinken 150/14 für Köckerling 862 mm hoch	269,00
(5)	Blattfederzinken 150/16 für Köckerling 887 mm hoch	269,00

### Hackschare zum anschweißen

Breite	Schar lose	Schar beschichtet	kpl. mit Stiel
100 mm	€ 18,50		€ 46,90
120 mm	€ 18,50		€ 49,90
140 mm	€ 18,50	€ 34,90	€ 39,90
160 mm	€ 19,90	€ 37,90	€ 42,50
180 mm	€ 20,90	€ 39,90	€ 42,50
200 mm	€ 22,50	€ 41,90	€ 42,50
220 mm	€ 36,50		€ 49,50
240 mm	€ 39,90		€ 49,50
260 mm	€ 42,50		€ 49,50
300 mm	€ 48,50		€ 49,90
400 mm	€ 54,00		€ 65,00

**Hackschar mit Stiel links oder rechts**  
Arbeitsbreite 185 mm € 54,50

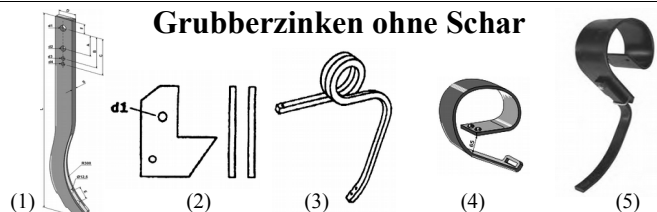
### Gänsefußschare passend für



Bild	Bezeichnung	Maße	Lochabstand	Gewicht	€
(1)	Amazone	170x 9 mm	45-75 mm	2,1 kg	14,90
(2)	Serie PWV 1100	280x 6 mm	45 mm	1,7 kg	26,50
(2)	Gänsefußschar	280x 6 mm	Fabr. Bellota	1,7 kg	15,90
(3)	Keil 2 Grad für Gänsefußschar PWV 1100				8,30
(3)	Keil 5 Grad für Gänsefußschar PWV 1100				9,90
(4)	Clemens	250x10 mm	45-55 mm	2,3 kg	17,90
(4)	Gänsefußschar	310x10 mm	45-75 mm	3,7 kg	25,50
(4)	Gänsefußschar	420x10 mm	45-70 mm	3,9 kg	44,50



(4b)	Gänsefußschar f. Maschio	285x 8 mm	45 mm	1,5 kg	14,90
(4b)	Gänsefußschar f. Maschio	285x 8 mm	beschichtet	2,0 kg	45,90
(4c)	Lemken 3374368	300x 8 mm	45 mm	2,8 kg	62,50
(5)	Gänsefußschar	310x 8 mm	45 oder 70 mm	2,1 kg	39,90
(5)	Gänsefußschar	420x 8 mm	45 oder 70 mm	3,0 kg	43,50
(5)	Gänsefußschar	460x 8 mm	45 oder 70 mm	3,4 kg	49,50
(6)	Köckerling 900863	450x 8 mm	45-70 mm	5,4 kg	54,00
(7)	Schälschar	250x 6 mm	45-75 mm	3,5 kg	64,50

### passend für Hatzenbichler

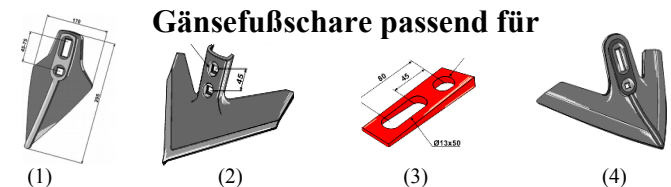
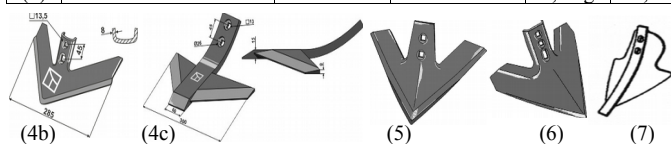
	€
Zinken kpl. ohne Schar	39,90
Oberfeder 32x12 lose	24,90
Stiel 30x10 lose	8,90
Halteflasche für Stiel	6,50
Spannkeil für Stiel	4,95
Gänsefußschar 150 mm	9,95
Gänsefußschar 200 mm	11,50
Gänsefußschar 250 mm	19,90

### Hackschare passend für Schmotzer Rapido

Breite	€	Breite	€
100 mm	11,90	200 mm	13,90
120 mm	11,90	220 mm	13,90
140 mm	13,50	240 mm	13,90
160 mm	13,50	300 mm	15,90
180 mm	13,50	380 mm	19,80
Stiel Rapido		29,50	

### Winkelmesser

	€
160 mm breit links / rechts	18,50
200 mm breit links / rechts	23,50
Stiele gebohrt gekröpft	13,90
Stiele gebohrt gerade	11,90

### Hackschare passend für

	Rau	Schmotzer	Schmotzer beschichtet
120 mm	9,90	9,90	24,50
140 mm	10,40	10,40	25,90
160 mm	11,50	11,50	27,50
180 mm	12,90	12,90	30,90
200 mm	14,90	14,90	33,50
220 mm		18,60	
240 mm		22,00	
260 mm		22,90	
300 mm		36,50	
Oberfeder 32x12 mm		42,90	
Stiel 30x10 mm ungelocht		13,90	
Stiel 30x10 mm gelocht		19,90	
Halteflasche für Stiel		6,50	
Spannkeil für Stiel		4,95	

### Kultizinken kpl. mit Schar

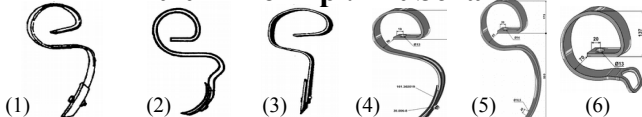

Form	Bezeichnung	Einbauhöhe	€	ab 10 St
(1)	Kultizinken 32x10 mm ital.	390 mm	14,90	13,90
(1)	Kultizinken 32x10 mm Germany 1a	390 mm	19,50	18,90
(1)	Kultizinken 32x12 mm	390 mm	17,90	16,90
(2)	Kultizinken 32x10 mm pass. f. Rau	400 mm	18,90	18,50
(3)	Kultizinken 32x12 mm Jackpott gerade	425 mm	21,90	20,90
(3)	Kultizinken 32x12 mm pass. f. 35310016	380 mm	22,50	21,50
(3)	dto. 32/12 pass. für Lemken 3535516	380 mm	38,00	34,50
(3)	Kultizinken 45x12 mm gerade	430 mm	42,50	39,50
(4)	Kultizinken 45x12 mm ital.	520 mm	29,50	26,90
(4)	Kultizinken 45x12 mm Germany 1a	520 mm	38,90	36,90
	Kultizinken p. f. Güttler 45x12 mm 16 Ø	460 mm	39,50	38,00
	Kultizinken p. f. Güttler 45x12 mm 16 Ø	530 mm	53,00	51,90
(4)	Kultizinken p. f. Väderstad 45x12 mm	380 mm	29,90	28,50
(5)	Kultizinken 60x12 mm ohne Schar LA26	530 mm	59,50	52,50
(6)	Verstärkungsfeder für 32x10 mm		13,90	12,90
(6)	Verstärkungsfeder für 45x10 mm		19,90	18,90

### Kultischare, Gänsefußschare und Schrauben

Form	Bezeichnung	€	ab 50 St.
(1)	Kultischar 1 Loch gebogen	200x40x6 mm	1,70 1,60
(1)	Kultischar verstärkte Ausführung	210x40x8 mm	2,60 2,40
(2)	Kultischar passend für Rau	stark gebogen	1,95 1,85
(3)	Kultischar gerade Ausführung	220x40x6 mm	2,40 2,20
(3)	Kultischar gerade pass. f. Lemken	170x40x8 mm	3,95 3,60
(3b)	Kultischar 2 Loch / LA 27 mm	260x50x6 mm	6,80 6,30
(3b)	Kultischar LA 27 mm beschichtet	260x50x6 mm	24,90 22,90
(4)	Ovalschraube 10x38	Güte 8.8	0,35 0,33
(4)	Ovalschraube 10x45	Güte 8.8	0,40 0,35
(4)	Ovalschraube 10x50	Güte 8.8	0,45 0,40
(4)	Ovalschraube 10x50	Güte 10.9	0,55 0,50
(4)	Ovalschraube 10x50	Güte 12.9	1,95 1,85
(4)	Ovalschraube 10x60	Güte 10.9	0,85 0,80
(4)	Ovalschraube 10x70	Güte 10.9	1,00 0,95
(5)	Gänsefußschar 1 Loch	70x6 mm	8,90 8,50
(6)	Gänsefußschar 1 Loch	105x4 mm	3,80 3,60
(6)	Gänsefußschar 1 Loch verstärkt	105x6 mm	4,90 4,50
(6)	Gänsefußschar 1 Loch f. Güttler	150x4 mm	4,80 4,50
(6)	Gänsefußschar 1 Loch beschichtet	150x4 mm	21,50 19,50
(6)	Gänsefußschar 1 Loch	175x4 mm	5,90 5,50
(6)	Gänsefußschar 1 Loch	200x4 mm	9,90 8,90
(6)	Gänsefußschar 1 Loch	250x4 mm	13,50
(7)	Gänsefußschar 2 Loch / LA 27 mm	200x6 mm	12,90 11,90

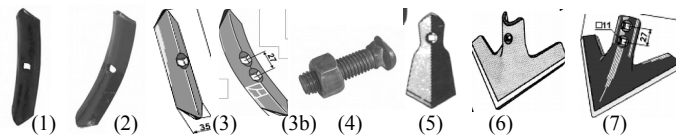

### Gänsefußschar passend für

	<b>Arns / Rau</b> 160 mm breit € 9,90		<b>Lemken Kompaktor</b> 280 mm 3374356 € 8,90 280 mm 3374357 € 11,90
--	---	--	--

### Halter für Kultizinken und Garezinken

Halter für	Rahmen	€	mit Verstärkungsfeder
Garezinken 25x 8	40x10 mm	2,25	
Garezinken 27x10	40x10 mm	2,25	
Kultizinken 32x10	50x12 mm	2,50	3,00
Kultizinken 32x12	50x15 mm	3,40	3,10
Kultizinken 45x12	50x50 mm	5,90	8,30
Kultizinken 50x13	60x60 mm	17,50	17,50
Kultizinken 60x12	60x60 mm	15,90	15,90
Kultizinken 70x12	60x60 mm	12,90	

weitere Rahmengrößen auf Anfrage

### Spurlockererzinken komplett mit Verstärkungsfeder

32/10/570 lg. für Amazone	€	32,50
40/10/750 lg.	€	39,50
Ersatzschar 135x40x6 mm	€	1,95

### passend für Köckerling, Agri-Farm, Einböck, Kuhn, Pöttinger, Sauerburger



Bild	Bezeichnung	Einbauhöhe	Org. Nr.	€	ab 10 St
(1)	Kultizinken 70x12 mm ohne Schar	580 mm	504008	59,90	54,90
(1)	Kultizinken 70x12 mm ohne Schar	580 mm	Eurozappa H2241260	54,90	49,90
	Kultizinken 70x12 mm f. Kuhn 1 Loch 12 Ø			84,50	79,90
(1)	Kultizinken 50x13 mm ohne Schar	530 mm	504004	48,90	45,50
(3)	Kultizinken 45x12 mm mit Schar	520 mm		29,50	26,90
(2)	Verstärkungsfeder für 45x12 mm mit Öse			19,90	18,90
(2)	Verstärkungsfeder für 50x13 mm mit Öse			29,90	28,90
(2)	Verstärkungsfeder für 70x10 mm mit Öse			54,90	51,90



Bild	Bezeichnung	Org. Nr.	€	ab 50 St
(4a)	Gänsefußschar 2 Loch 180x6 mm verst.	504027	10,90	9,90
(4a)	Gänsefußschar 2 Loch 200x6 mm Frank	504032	10,90	9,90
(4a)	Gänsefußschar 2 Loch 200x6 mm Aktion	504032	8,90	7,90
(4a)	Gänsefußschar 2 Loch 200x6 beschichtet	504032	17,90	16,90
(4a)	Gänsefußschar 2 Loch 200x6 Duraface	504032	33,50	31,90
(4a)	Gänsefußschar 2 Loch 220x6 mm Frank	504032	11,90	10,90
(4a)	Gänsefußschar 2 Loch 240x6 mm	f. Einböck	18,90	
(4b)	Gänsefußschar 2 Loch 200 mm / Widia	504032	79,90	
(4c)	Gänsefußschar 2 Loch 220 mm / Widia	936742	96,50	2,7 kg
(4d)	pass. für Kuhn 1 Loch 200x6 mm	H2243170	13,50	
(5)	Kultischar 2 Loch 300x60x10 mm	504019	8,90	7,90
(5)	Kultischar 2 Loch beschichtet	504019	17,90	16,90
(6)	Kultischar 2 Loch mit Widiaplatte	915772	42,50	
(7)	Kultischar 3 Loch 300x60x10 mm	504019	9,90	8,90
(8)	Kultischar 1 Loch 260x50x 6 mm	504011	4,20	3,80
(9)	Schar f. Güttler 1 Loch 260x50x 8 mm	72000367	8,90	7,90

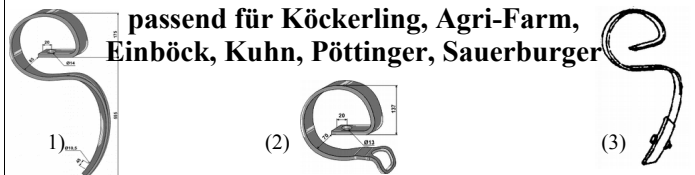

### Garezinken und Gareschare

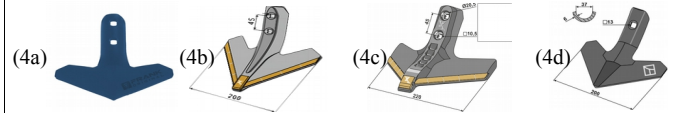
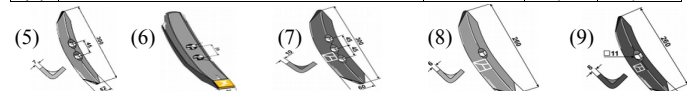
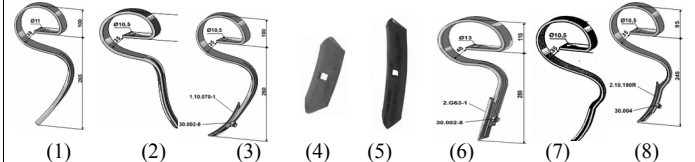

Form	Bezeichnung	Einbauhöhe	€	ab 30 St
(1)	Garezinken 25x 8 mm ital.	260 mm	5,90	5,50
(1)	Garezinken 25x 8 mm Germany 1a	280 mm	8,30	7,90
(1)	Garezinken 27x10 mm	280 mm	10,90	
(2)	Garezinken 25x 8 mm vorne	280 mm	7,50	
(3)	Garezinken 25x 8 mm mit Schar	280 mm	10,90	
(4)	Gareschar 135x40x6 mm / Loch 10 mm		1,95	
(5)	Gareschar 170x30x5 mm / Loch 10 mm		2,90	
(6)	Garezinken 32x10 mm mit Schar gerade	290 mm	14,90	13,90
(7)	Garezinken 25x 8 mm pass. für Rau	250 mm	7,40	6,90
(8)	Garezinken pass. für Rau mit Schar	250 mm	11,90	
(5)	Gareschar 140x25x5 mm pass. f. Rau / Loch 8 mm		2,20	

### Lager für Walzenkrümmer

Holzlager				Plastiklager			
außen-Ø	innen-Ø	Breite	€	außen-Ø	innen-Ø	Breite	€
64 mm	25 mm	40 mm	4,90	45 mm	32 mm	40 mm	6,30
64 mm	28 mm	40 mm	4,90	64 mm	32 mm	40 mm	9,40
64 mm	30 mm	40 mm	4,90	Eisenring	70x64x40 mm		9,50
64 mm	32 mm	40 mm	4,90	Staubring	88x81x30 mm		8,90

### Eggenzinken spezialgehärtet mit Mutter

18 x 190 Gewinde M 14	€	6,90
20 x 200 Gewinde M 16	€	7,40
20 x 220 Gewinde M 16	€	7,95
20 x 240 Gewinde M 16	€	8,50
20 x 220 Gewinde M 18	€	9,80
22 x 240 Gewinde M 20	€	12,90

### Konuseggenzinken passend für Rau

23/20x220 M16 € 7,90

**Scharschrauben**



Pflugschraube Vierkant DIN 608						
Länge	M10	M12	M12	M14	M16	M20
<b>Güte</b>	<b>8.8</b>	<b>10.9</b>	<b>12.9</b>	<b>8.8</b>	<b>8.8</b>	<b>1 Nase</b>
30/35	0,40	0,50	0,70	0,80		
40/45	0,45	0,50	0,70	0,90	1,90	
50	0,50	0,55	0,70	1,00	2,30	3,95
60	0,75	0,70	0,70		2,50	3,95
70		0,70	0,80		2,50	
80		0,80	0,85		2,90	4,60
90		0,90	1,30		2,90	4,80

	Kuhn/Huard-Schraube 2 Nasen	12x35 mm	€ 0,90
	Kuhn/Huard-Schraube 2 Nasen	14x35 mm	€ 1,00
	Kverneland-Konusschraube	12x32 mm	€ 0,60
	Kverneland-Konusschraube	12x38 mm	€ 0,70
	Kverneland-Konusschraube	14x34 mm	€ 0,90
	Naud-Schraube 2 Nasen	14x40 mm	€ 1,50
	Rabe-Konusschraube	12x35 mm	€ 0,70
	V&Noot Konusschraube	14x36 mm	€ 1,00
	Körperschraube mit Vierkant	16x1,5x80 mm	€ 3,90

**passend für Gassner**

**Schnabelschar**

SS 1080/90	U1003/1013/1203	€ 58,50
SS 1180/90		€ 57,50
SS 1100/10	U1303	€ 56,50
SS 1140/50	U1503	€ 59,90
SS 11886/87	GS351/NS33/NS36	€ 62,50
SS 11886/87	beschichtet	€ 91,50

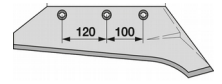

**Wechselspitzschar + Wechselspitze**

MRS 11392/93	= SS1180/90	€ 60,90
MRS 11384/85	= SS1100/10	€ 57,90
MRS 11858/59	= SS11400/401	€ 59,90
MRSS 1580/90		€ 60,90
Wechselspitze	2 Loch	€ 8,50
Wechselspitze	3 Loch	€ 9,50

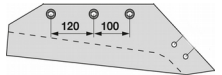

**Anlage + Schleifklotz**

L 1083/93		€ 56,50
L 1123/33		€ 54,90
L 1582 L/R	drehbar	€ 44,50
G 1/2	Schleifklotz	€ 19,50



**Riester-Vorderteil**

VST 1120/30		€ 34,00
VST 1160/70		€ 29,50

**Riester-Hinterteil**

HST 1120/30		€ 149,00
HST 1160/70		€ 149,00

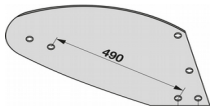

**Düngereinlegerschar**

11826/27		€ 17,90
11834/35		€ 21,50

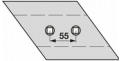

**Anschweißspitzen für Schar:**

AS 185-32 L/R aufgebogen € 7,50  
AS 130-60 L/R flach € 7,90

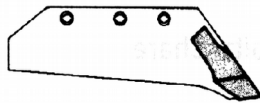

**passend für Gregoire Besson**

173613/614	Wechselspitzschar	€ 54,90
173331/332	Wechselspitze 3 Loch	€ 12,90

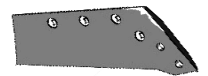

**passend für Eberhardt**

54554/55	Schnabelschar	€ 59,50
54554/55	Wechselspitzschar	€ 59,50
	Wechselspitze 2 Loch	€ 8,50
54556/57	Perfektschar	€ 59,90
302490/91	Schar-Vorderteil	€ 36,90
306195/96	Schar-Hinterteil	€ 43,90
110210/11	Anlage kurz	€ 34,50
110222/23	Anlage lang	€ 49,90
301162	Anlage wendbar	€ 38,90
22602/03	Düngereinleger-Schar	€ 15,90
4000/01	Riester-Vorderteil	€ 29,50
301160/61	Riester-Vorderteil	€ 38,90

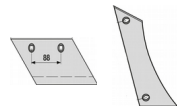
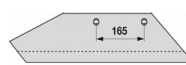
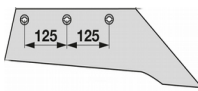

**passend für Krone**

KG 12S	969007/107	Schnabel-Schar	€ 55,90
KG 12	969021/121	Wechselspitz-Schar	€ 55,90
KG 14/16	969029/129	Wechselspitz-Schar	€ 59,90
M 1000	929099/199	Wechselspitze	€ 10,50
KS 216	969096/169	Wechselspitz-Schar	€ 61,50
	9690980	Wechselspitze KS	€ 11,90
KG	123029/159	Anlage 280 mm lang	€ 29,50
KG	123162/163	Anlage 470 mm lang	€ 35,90
KG	123160/161	Anlage 550 mm lang	€ 43,90
KG	123164/165	Anlage 650 mm lang	€ 50,90
KG 12	123112/166	Anlagenspitze	€ 17,50
VD 141	969091/191	Düngereinleger-Schar	€ 16,30

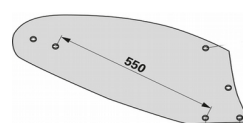
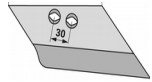
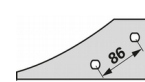
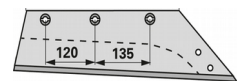
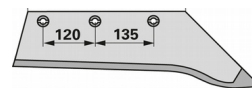

KG 101/121	959405/425	Riester-Vorderteil	€ 29,50
KG 121	959209/309	Riester-Hinterteil	€ 125,00

**passend für Frost**

50614/615	Wechselspitzschar	€ 61,50
50612/613	Wechselspitze	€ 18,90

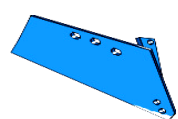

**passend für Howard - Schwenkflug**

187314	Schwenkschar	€ 62,90
--------	--------------	---------

**passend für Kuhn**

**Wechselspitzen**

		NB	Frank
622128/29 Z	12 mm Standard	11,90	10,50
622174/75 Z	15 mm verstärkt	15,50	15,50
622128/29	beschichtet	24,90	29,90
622164/65	mit Widiplatte	39,50	59,90



**Wechselspitzenchar**

622134/35	14°	46,50	51,90
622136/37	16°=62212/213	46,50	56,50
622136/37	16°=622172/173	46,50	56,50
622136/37	beschichtet	84,50	
622136/37	mit Widiplatte	169,00	
622208/09	18°	77,50	
H0405800/10	16°	56,50	

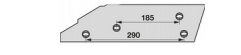
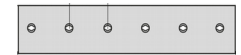
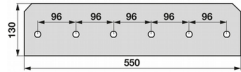
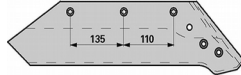

**Anlage**

279140	6 Loch	22,90	23,90
279140	12 mm verstärkt	34,90	
761108	6 Loch drehbar	20,50	24,50
761108	12 mm verstärkt	32,90	
27874/75	kurz	20,90	20,90
27876/77	lang	35,90	35,90
279114/15	hohe Ausf.	46,50	38,90
763008/09	Schleifklotz	12,95	
H0400610	Anlagenschoner		26,50

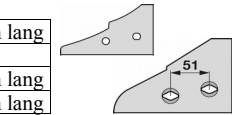

**Anlagenspitze**

223120/21	LA 65 mm	10,90	195 mm lang
279138/39	LA 50 mm	12,50	
761106/07	LA 65 mm	13,90	158 mm lang
761110/11	LA 50 mm	13,50	152 mm lang

**Düngereinleger-Schar**

631100/01	LA 65 mm		13,80
631112	drehbar 65 mm	16,90	19,80
631102/03	LA 85 mm		10,50
631108/09	LA 65 mm		12,90

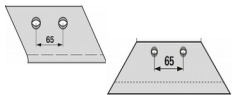

**Düngereinleger-Riester**

618104/05	LA 65 mm	19,50	24,50
619132/33	LA 65 mm		33,50

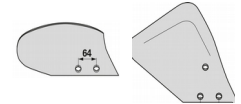

**Riester-Vorderteil**

619128/29	3 Loch		21,90
619172/73	4 Loch	23,90	29,50
619200/01	2 Loch	16,90	18,50

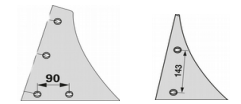

**Riester-Hinterteil / Streichschiene / Stroheinlegeblech**

616090/91		119,00	119,00
616138/39		129,00	159,00
648102/03	Streichschiene	23,50	
619122/23	Einlegeblech	22,50	
619159	Einlegeblech	29,50	29,50

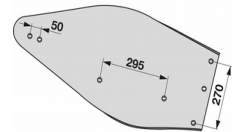

**Streifen**

619060/61	Vorderteil 2 Loch	18,50	19,50
617106/07	=H0404710/20		28,50
617104/05	=H0404690/00		30,90
617102/03	=H0404670/80		35,90
617100/01	=H0404650/60		39,50



H0403520/30	Vorderteil	27,90	28,90
H0403180/90	Streifen #1	30,90	35,50
H0403200/10	Streifen #2	30,90	35,50
H0403220/30	Streifen #3	37,50	39,50
H0403240/50	Streifen #4	49,90	49,90

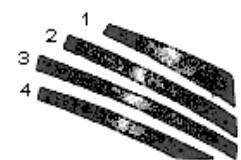

**Scheibenseche**

110027	500 mm gezahnt		
	5 Loch m.Mittelloch	€	89,90
110029	500 m gezahnt		
	6 Loch / LK 100 mm	€	69,00

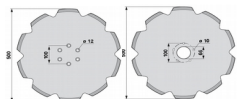

**passend für Kverneland**

**Wechselspitzen**

		NB	Frank
53090/63090	12 mm Standard	6,90	7,20
53090/63090	15 mm verstärkt	7,50	8,90
53090/63090	Fabr. iQ beschichtet	18,90	
53090/63090	beschichtet	22,90	
53090/63090	mit Widiplatte	49,90	59,50

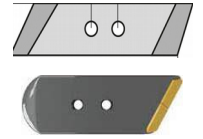

**Wechselspitzenchar**

63014/17		€	37,90
63015/18		€	39,50
73002/03		€	39,90
73004/05	Fabr. iQ	€	30,90
73004/05	Fabr. Mölbro	€	32,90
73006/07	Fabr. iQ	€	32,90
73006/07	Fabr. Frank	€	39,50
73006/07	Fabr. Mölbro	€	39,50
73008/09		€	47,90
73056/57		€	35,90
73080/81	Fabr. iQ	€	37,90
73080/81	Fabr. Mölbro	€	42,90
73084/85		€	55,90

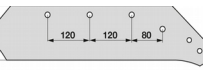
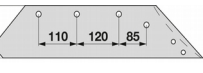

**passend für Quick-Fit System**

KK304303R	Knock-On 304349R	€	12,90
83090	Quick-Fit Spitze Org.	€	19,90
83012/13	Spitze beschichtet	€	48,50
83020/21 18°	Schar Fabr. Mölbro	€	29,50
83022/23 20°	Schar Fabr. Mölbro	€	32,50

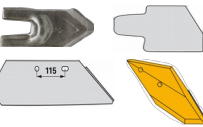

**Schnabelschar**

63001/07	12 mm verstärkt	€	57,50
73024/25	12 mm verstärkt	€	57,90
73026/27	12 mm verstärkt	€	59,90
73080/81	12 mm verstärkt	€	61,90
73080/81	beschichtet 2-tlg.	€	79,50
73084/85	beschichtet 2-tlg.	€	79,50



**Anlage / Anlagenschoner / Anlagenseche**

73608	kurz	€	32,90
73608	12 mm verstärkt	€	34,90
73609	lang	€	39,50
73609	12 mm verstärkt	€	42,90
63600A	Schoner alte Ausf.	€	11,50
73614	1 Nase neue Ausf.	€	7,90
73091/92	Anlagenseche	€	16,50
73088/89	Anlagenseche	€	29,90
84320/21	Anlagenseche	€	39,50
63605/06	kurz	€	30,90
63603/04	lang	€	37,50

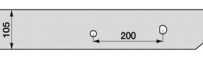
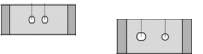
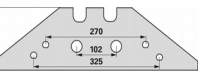

**Düngereinleger-Schar**

56873/66873	Rückenlänge 190mm	€	10,50
66868/66869	Rückenlänge 220mm	€	11,90

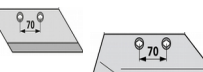

**Düngereinleger-Riester**

66880/81	= 66878/79	€	22,50
76812/13	Mais-Einleger	€	26,90

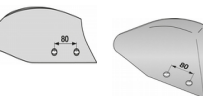

**Riester-Vorderteil**

63240/50	1 Loch	13,90	17,90
73256/57	3 Loch	16,50	22,00
73230/31	3 Loch	18,50	22,50
73250/51	2 Loch	14,90	18,90

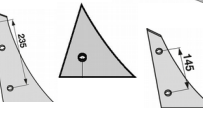

**Riester-Hinterteil / Streichschiene / Stroheinlegeblech**

63261/71		€	119,00
73260/61		€	185,00
73286/87		€	139,00
73290/91	Fabr. Frank	€	129,00
83228/29	Körperform Nr. 28	€	149,00
84243/44	pass. für Ecomat	€	95,00
53387/63388	Streichschiene	€	15,90
73300/01	Stroheinlegeblech	€	29,90
73310/11	Halter für dto.	€	25,90

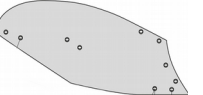

**Scheibenseche + Lager**

56112 glatt	450mm 3 Loch	€	49,50
56115 gezahnt	450mm 3 Loch	€	59,90
56116 gezahnt	500mm 3 Loch	€	84,90
76410 gezahnt	500mm 4 Loch	€	109,00
60624	Lager 30 mm	€	79,50
60609	Lager 34 mm	€	79,50
56156	Lagerdeckel	€	19,50
KK010572	Lager neu lose	€	23,50

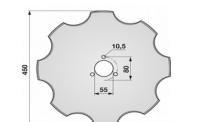

**passend für Lemken**

**Schar-Vorderteil**

		NB	Frank
3364050/51	12 mm Standard	14,90	
3364050/51	15 mm verstärkt	14,90	14,90
3364150/51	beschichtet 12 mm	27,50	
3364150/51	beschichtet 15 mm	29,90	34,90
3364150/51	mit Widiplatte		69,50
3365540/41	Wechselspitze	15,90	18,90
3364156/57	beschichtet Org. für Juwel		79,00
33610010/11	für trockene Böden		39,90

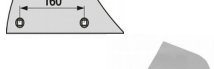
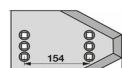
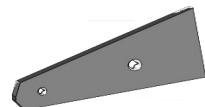
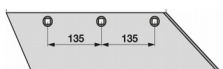
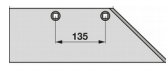

Original

**Scharblatt**

		NB	Frank
3352120/21	= 3352020/21	33,90	33,90
3352130/31	= 3352030/31	29,90	34,90
3352230/31	beschichtet	59,90	69,50
3352134/35	= 3352034/35	32,90	38,50
3352234/35	beschichtet	59,90	74,90
3352134/35	mit Widia		154,00
3352138/39	pass. f. Juwel	34,50	39,90
3352138/39	beschichtet		76,90

**Anlage**

		NB	Frank
3411504	4Loch	21,50	24,50
3411504	beschichtet 2-seitig	49,90	
3411460	8 Loch	44,50	47,50
3401490	Anlagenschoner	33,90	37,50
3411525	pass. f. Juwel	47,90	55,90
34110002/03	pass. f. Juwel	39,90	44,90

**Anlagenspitze + Anlagenseche**

		NB	Frank
3401900/01	Anlagenspitze	10,50	13,90
3401903	pass. f. Juwel	13,90	24,90
3492890/91	Anlagenseche	18,90	29,50

**Düngereinleger-Schar**

		NB	Frank
3363712/13	= S 150	9,90	
3363714/15	= S 185	11,90	11,90
3363720/21	= S 190	9,90	11,90
3363728/29	= S 205	19,90	
3363722/23	= S 245	15,90	17,50
3363710/11	= S 270	9,90	11,90
3363724	= S 360 R/L		15,90
3363726/27	= S 370		19,90

**Düngereinleger-Riester**

		NB	Frank
3470650/651	= D1		26,90
3470564/565	= M1	34,50	39,50
3470600/601	= M2	45,90	49,90
3470620/621	= M3	38,50	43,90
3470660/661	p. f. DuraMaxx		43,90

**Riester-Vorderteil**

		NB	Frank
3451000/01	Standard	19,90	26,50
3451002/03	10 mm verstärkt	26,90	31,50
3451004/05		22,50	26,50
3451010/11		23,90	29,90
3451030/31	Nachbau Juwel	59,00	149,00

**Riester-Hinterteil / Streichschiene / Stroheinlegeblech**

		NB	Frank
3441030/31	B30	129,00	145,00
3441034/35	B35	129,00	165,00
3441040/41	B40	129,00	149,00
3476000/01	Streichschiene	18,90	22,90
3470860/61	Einlegeblech	33,90	35,90

**Streifen**

		NB	Frank
3444010/11	Streifen #1	33,90	45,50
3444012/13	Streifen #1 breit	40,90	58,00
3444020/21	Streifen #2	37,50	45,50
3444030/31	Streifen #3	39,90	57,00
3444040/41	Streifen #4	44,90	55,90
3444042/43	Streifen #4 breit	58,00	73,50

**Scheibenseche**

		NB	Frank
3490042	500 mm gezahnt	€	69,00
3490029	500 mm glatt	€	69,00

Original

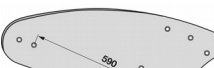

**passend für Lemken Körperform BU / NBU**



			€
3363986/87	WG 2S	Schar-Vorderteil	17,90
3351958/59	WG100 B	Schar-Hinterteil	31,50



			€
3333812/13	M 24 S	Schnabelschar	59,50
3334056/57	M 24 W	Wechselspitzschar	59,50

			€
3334090	RB 1	Schwensschar	63,90

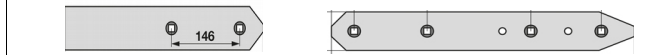

			€
3401570	A1 VL	Anlage kurz	28,50
3411826	A1	Anlage lang	37,50
3492900/01	AS 1	Anlagenseche	39,50

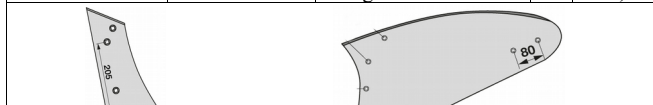

			€
3450524/25	BU 2K	Riester-Vorderteil	28,90
3440718/19	NBU 1B	Riester-Hinterteil	159,00
3440712/13	BU 1B	Riester-Hinterteil	159,00

**passend für Naud**

		€
03054502	Wechselspitze	13,50
03054152	Wechselspitz-Schar F	45,90
03065501	Anlage 330 mm lang	26,50
03065101	Anlage 410 mm lang	42,50
04032101	Düngereinleger-Schar kz.	12,50
04032101	Düngereinleger-Schar lg.	14,90
04023103	Düngereinleger-Riester	49,50
03022352	Riester-Hinterteil / C31	149,00
03023657	Riester-Hinterteil / H67A	179,00

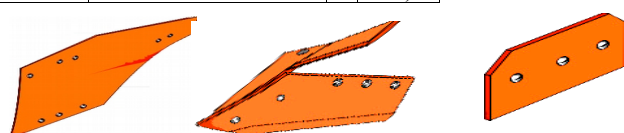

**passend für Niemeyer**

			€
24104	24105	Wechselspitze	11,90
NU 9SS	= 20031/32	Schnabel-Schar	45,80
NW121		Wechselspitz-Schar	59,90
N152	= 200614/15	Schnabel-Schar	56,90
N152	= 200616/17	Wechselspitz-Schar	56,90
N13/15	= 200618/19	Perfektschar	59,90
N182	= 200810/11	Wechselspitz-Schar	63,90
SH15G	= 200678/79	Schar-Vorderteil	27,50
SH15G	= 024106/07	Schar-Hinterteil	36,90
N15G	= 020619/20	Anlage kurz	37,50
N15G	= 020621/22	Anlage lang	52,90
024072	= 024074	Anlage wendbar	37,50
024004		Anlagenspitze	17,50
024013		Anlagenspitze	16,90
3 AR	= 026087/88	Düngereinleger-Schar	14,90
N15G	= 020735/36	Riester-Vorderteil	36,90
N15G	= 020737/38	Riester-Hinterteil	129,00
NU16G	= 024080/81	Riester-Vorderteil	37,90
024131	024132	Streifen #1	62,50
024127	024128	Streifen #2	57,00
024125	024126	Streifen #3	69,50
024129	024130	Streifen #4	98,00

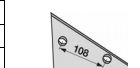
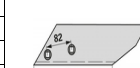
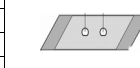
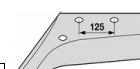

**passend für Maschio**

A51908060/70	Wechselspitzschar	€	59,90
A51908100/10	Wechselspitzschar	€	39,50
A52000010/20	Spitze LA 50 mm	€	12,00
A52000200/10	Spitze LA 40 mm	€	8,90
A51807010/11	Düngereinlegerschar	€	20,50
A52100032	Anlage drehbar L/R	€	56,50

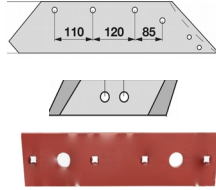

Riester-Vorderteile und -Hinterteile auf Anfrage

**passend für Pöttinger / Landsberg**

**Wechselspitze**

925.130.110	925.130.210	€	17,90
925.260.110	925.260.210	€	18,90
930.76.127.0	930.77.127.0	€	9,90
930.201.250	930.211.250	€	12,50
041662/63	Schar-Vorderteil	€	41,90

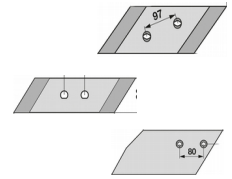

**Wechselspitzschar**

925.131.160	925.131.260	€	57,50
925.260.130	925.260.230	€	59,50
930.401.200	930.411.200	€	60,90
930.76.121.0	930.77.121.0	€	42,90
930.78.122.0	930.79.122.0	€	54,50
1903654	1903655	€	59,90
1903684/85	Schar-Hinterteil	€	38,50

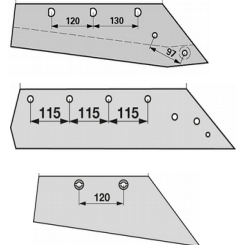

**Schnabelschar**

930.76.132.0	77.132.0 beschichtet	€	98,50
1902740/50	= 010513 / 010514	€	55,90

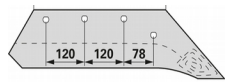

**Anlage / Anlagenschoner**

929.100.101	8 Loch	€	29,90
929.100.201	Anlagenschoner 4L	€	33,50
929.100.210	Anlagenschoner 7L	€	59,90
041910	3 Loch kurze Ausf.	€	32,90
041911	4 Loch lange Ausf.	€	39,90

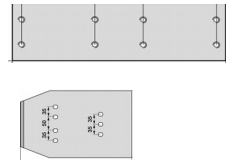

**Anlagenspitze**

929.100.001	190 mm lang	€	18,40
929.101.000	220 mm lang	€	31,50
930.700.050	267 mm lang	€	17,50
930.76.005.0	260 mm lang	€	19,50
930.78.005.0	228 mm lang	€	19,90
930.82.115.0	300 mm lang	€	19,90

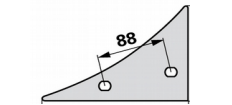

**Düngereinleger-Schar**

921.041.180	921.041.280	€	16,90
921.052.250	921.062.250	€	18,90
1903693/94	001847 / 001848 Z	€	20,90

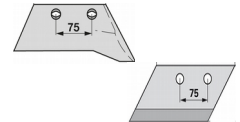

**Düngereinleger-Riester**

1903697	1903698	€	34,90
001849 Z	001850 Z	€	31,50
921.05.230.0	921.06.230.0	€	26,90
921.05.330.0	921.06.330.0	€	28,50

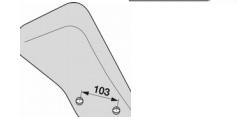

**Riester-Vorderteil**

930.20.135.0	930.21.135.0	€	45,90
930.76.035.0	930.77.035.0	€	28,90
930.78.036.0	930.79.036.0	€	39,90
041386	041387	€	32,90

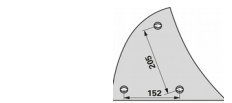

**Riester-Hinterteil**

930.76.030.0	930.77.030.0 / 46W	€	169,00
930.78.031.0	930.79.031.0 / 46Wc	€	189,00
041384	041385	€	149,00

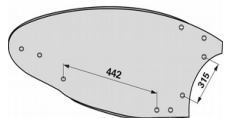

**Streifen**

Körperform 35 WSS		
041878/79	€ 42,50	Streifen (1)
041876/77	€ 38,50	Streifen (2)
041874/75	€ 45,80	Streifen (3)
041872/73	€ 44,90	Streifen (4)
041884/85	€ 34,90	Riester-Vorderteil

Körperform 30/35 UWS		
041617/18	€ 45,90	Streifen (1)
041615/16	€ 42,50	Streifen (2)
041613/14	€ 44,90	Streifen (3)
041611/12	€ 44,90	Streifen (4)
041386/87	€ 32,90	Riester-Vorderteil

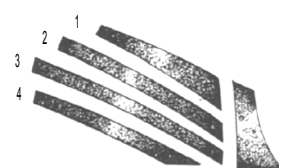

**passend für Överum / Kongskilde / New Holland**

**Schar-Vorderteil / Wechselspitze**

94608/09	Spitze XS/XL/XU	€	12,90
92206/07	=84060/85143 UC	€	11,90

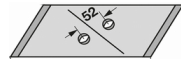

**Scharblatt**

94600/01	XL Körper 16"	€	29,90
94602/03	XL Körper 18"	€	34,90
96090/91	XS/XU Körper 16"	€	32,90
96092/93	XS/XU Körper 18"	€	34,90

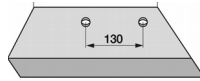

**Anlage + Anlagenseche + Anlagenschoner**

94604/05	XL Körper	€	34,90
96094/95	XS/XU Körper	€	34,90
94622/23	Anlagenseche XL/XU	€	19,80
94289	Anlagenschoner	€	21,90
85118/85197	lang UC Körper	€	29,50
83981/85196	kurz UC Körper	€	25,90



**Düngereinleger-Schar**

91801/02		€	12,90
93054/55		€	16,90

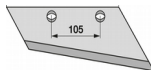

**Düngereinleger-Riester**

91803/04		€	28,50
----------	--	---	-------

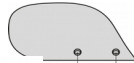

**Riester-Vorderteil**

94596/97	XL Körper	€	18,90
96086/87	XS/XU Körper	€	29,50

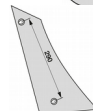

**Riester-Hinterteil**

94594/95	XL Körper	€	149,00
96084/85	XS/XU Körper	€	149,00

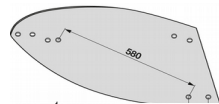

**Streifen**

20249 / 20894	Streifen #1	€	59,50
20250 / 20895	Streifen #2	€	61,50
20251 / 20896	Streifen #3	€	63,50
20252 / 20897	Streifen #4	€	69,90
21470 / 21599	Vorderteil	€	31,90



**passend für Regent**

SW 670.6	Wechselspitzschar	€	69,50
SWS 600	Wechselspitze	€	18,90

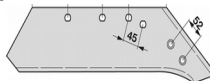

**passend für Unia**

10.6791.100	10.6792.100	Wechselspitzschar	€	54,90
10.6727.000	10.6728.000	Wechselspitze	€	14,50

**Agro-Masz, Amazone, und weitere Fabrikate auf Anfrage lieferbar**

**passend für Rabe**

**Wechselspitze**

MP332-0		€	9,80
MP293-0		€	9,90
MP293-0	beschichtet	€	20,90
MP350-0		€	9,90
MP350-0	beschichtet	€	20,90

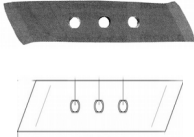

**Wechselspitzschar**

SSP293-0S	iQ Parts	€	52,90
SSP294-0S	iQ Parts	€	52,90
SSP294-0S	Mölbro	€	55,90
SSP331-0S		€	54,90
SSP332-0S	iQ Parts	€	41,50
SSP332-0S	Mölbro	€	44,50
SSP350-0S	iQ Parts	€	49,80
SSP350-0S	Mölbro	€	54,90
SSP351-0S		€	62,50

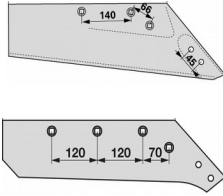

**Schnabelschar**

SSP 200 JB		€	43,90
SSP293-0		€	55,90
SSP294-0	iQ Parts	€	52,90
SSP294-0	beschichtet iQ Parts	€	64,90
SSP331-0		€	55,90
WEP 351	beschichtet Mölbro	€	86,00
WEP 351	beschichtet Frank	€	99,00

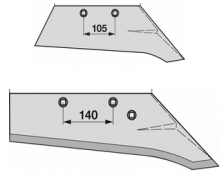

**Perfektschar**

DSP 200 J	Diamantschar	€	50,90
DSP330-0	Diamantschar	€	59,90
DSP293-0	Diamantschar	€	59,90



**Anlage / Anlagenschar / Anlagenseche**

VP202	kurz	€	21,50
WP203-0	lang	€	33,50
NG61	Anlagenseche	€	64,90
VP292-0	kurz	€	24,90
WP292-0	lang	€	36,90
NG71	Anlagenseche	€	60,90
VP300-0	kurz	€	26,50
WP300	lang	€	39,50
VP350W	= VP351W kurz	€	25,90
WP350W	= WP351W lang	€	43,50
YP350W	Anlagenseche	€	12,90
NG35	Anlagenseche	€	60,90
UP 9	Schleifklotz	€	18,50
XP4	Anlagenschar	€	14,50
XP6	Anlagenschar	€	34,90

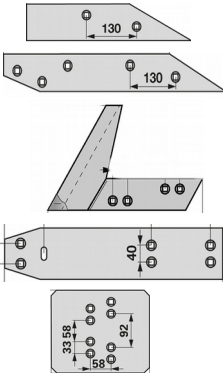

**Düngereinleger-Schar**

SDG14-16		€	13,95
SDG181		€	12,90
SDG18B		€	15,90

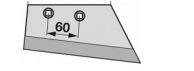

**Düngereinleger-Riester**

RDG17		€	49,50
RDG21		€	39,50
RDG181		€	39,50

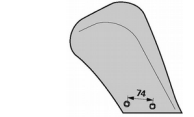

**Riester-Vorderteil**

VRP230-0		€	21,50
VRP292-0		€	21,50
VRP342/R		€	26,90
VRP300-0		€	29,90
VRP 330W		€	29,90
VRP 350W		€	29,90

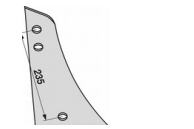

**Riester-Hinterteil / Streichschiene / Stroheinlegeblech**

HRP235-0	Riester-Hinterteil	€	98,00
HRP236-0	Riester-Hinterteil	€	149,00
HRP296-0	Riester-Hinterteil	€	149,00
HRP 297R	Riester-Hinterteil	€	149,00
HRP 327P	Riester-Hinterteil	€	169,00
HRP 350W	Riester-Hinterteil	€	195,00
PDG6	Stroheinlegeblech	€	59,00
PDG52	Stroheinlegeblech	€	59,00

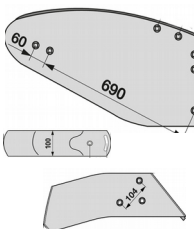

**passend für Rabe**

**Streifen**

SRP 236-01	€ 43,90	Streifen #1	SRP 328-P1	€ 52,90
SRP 236-02	€ 49,50	Streifen #2	SRP 328-P2	€ 49,90
SRP 236-03	€ 51,50	Streifen #3	SRP 328-P3	€ 64,90
SRP 236-04	€ 55,90	Streifen #4	SRP 328-P4	€ 63,50
SRP 236-04B	€ 63,50	#4 breite Ausführung	SRP 327-PB4	€ 96,90

SRP 350-W1	€ 49,90	#1	Fabr. Frank	€ 54,90
SRP 350-W2	€ 48,90	#2	Fabr. Frank	€ 56,00
SRP 350-W3	€ 53,90	#3	Fabr. Frank	€ 60,90
SRP 350-W41	€ 75,90	#4	Fabr. Frank	€ 86,00

SRP 330-W1	€ 53,90	#1	SRP 358-R1	€ 59,00
SRP 330-W2	€ 45,90	#2	SRP 358-R2	€ 67,00
SRP 330-W3	€ 49,90	#3	SRP 358-R3	€ 79,50
SRP 330-W4	€ 69,00	#4	SRP 358-R4	€ 75,80

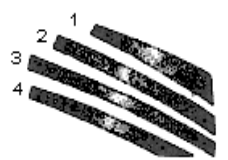

**Scheibenseche**

SCG 52 Z	500 mm gezahnt	€	79,00
----------	----------------	---	-------



**passend für Vogel & Noot / Amazone**

**Wechselspitze**

PK8.011.01/02	Standard 12 mm	€	8,95
PK8.011.01/02	14 mm Fabr. Agriforge	€	8,95
PK8.011.01/02	verstärkt 15 mm	€	10,90
PK8.011.01/02	verstärkt 15 mm Frank	€	12,50

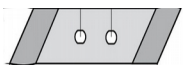

**Wechselspitzschar**

LK200105/106	= WSM 40 / WS400	€	52,50
LK200107/108	= WSM 43 / WS430	€	56,50
LK200123/124	= WXH 430	€	64,90
PK4.013.01/14	= UNM40 / UN 400	€	58,90
PK5.013.01/14	= UNM43 / UN 430	€	59,90

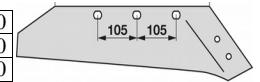

**Schnabelschar**

PK0.000.05/06	WS400	€	52,50
PK0.000.07/08	WS430	€	52,50
PK4.001.00/02	UN400	€	58,90
PK5.001.00/02	UN430	€	59,90
CV0.000.15/16	M950/U13/SS1100	€	56,90
P91.030.01/31	M950/U15/SS1140	€	58,90

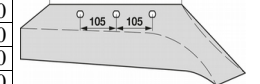

**geteiltes Schar passend für Amazone**

7200676/677	Schar-Vorderteil	€	36,50
7200678/679	Schar-Hinterteil	€	56,90
7200676/677	1-teiliges		
7200678/679	Schnabelschar	€	56,90
72000984/985	DE-Schar	€	18,90

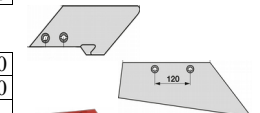

**Anlage + Anlagenschar**

PR7.030.03	Anlage 2 Loch	€	17,50
PR7.030.02	Anlage 3 Loch	€	24,90
PR7.030.04	Schar 228 lg.	€	22,50
PK8.130.03	PK8.140.03 Spitze	€	27,50
PK8.034.01	PK8.035.01	€	25,90
P89.034.01	P89.035.01 kurz	€	27,50
P89.036.01	P89.037.01 lang	€	39,90
P58.011.01	Schar kurz 215 lg.	€	22,90
P58.009.01	Schar lang 410 lg.	€	44,50
PK2.015.01	PK2.016.01 / Seche	€	58,50

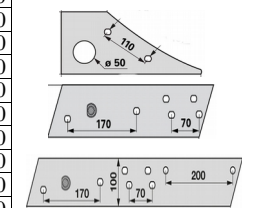
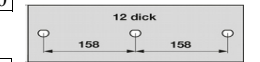

**Düngereinleger-Schar**

PA3.054.01	PA3.055.01	€	14,90
------------	------------	---	-------

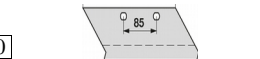

**Riester-Vorderteil**

PK8.00501/06	WY400A	€	31,90
PK0.00102/202	WL430 / WS400	€	44,90
PK3.00103/02	UN350	€	29,50
PK4.00103/02	UN400	€	29,50

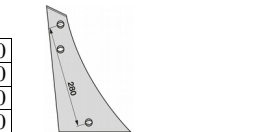

**Riester-Hinterteil**

PK8.001.09/02	WY400A	€	169,00
PR8.001.01/02	WL430	€	209,00
PK3.001.01/02	UN350	€	149,00
PK4.001.02/02	UN400	€	149,00

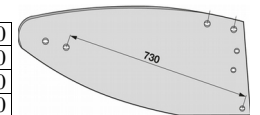

## Schnellwechszelzinken passend für

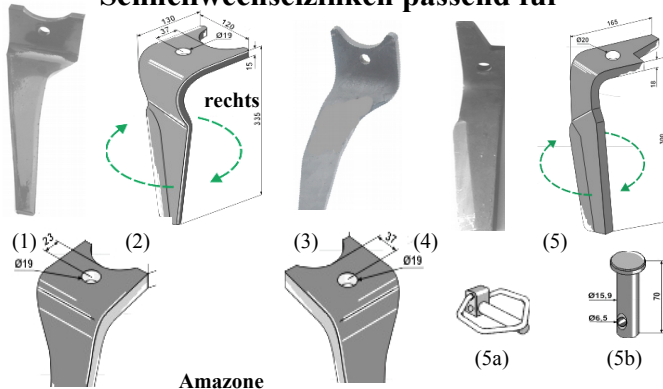

**Amazone**

alte kurze Aufnahme bis 2015  
23 mm bis Lochmitte

lange Aufnahme ab 2015  
37 mm bis Lochmitte

Form	Bezeichnung	Maße mm	Typ	€
(1)	Amazone 6574300 / 5300	350x120x15	Standard	19,90
(1)	Amazone 6170300 / 1300	350x120x15	beschichtet	44,50
(2)	Amazone 962337 / 338	330x120x15	gedrehte Ausführung	24,90
(3)	Amazone 967495 / 496 alt	330x120x15	Super-Grip	22,90
(3)	Amazone 967495 / 496 lange Aufnahme		Super-Grip	25,90
(3)	Amazone 967495 / 496 lange Aufnahme		beschichtet	57,50
(4)	Amazone 950788 / 789	300x 60x15	KE 302	15,90
(4)	Amazone 954426 / 427	300x 60x18	KE 303	14,95
(4)	Amazone	300x 60x18	beschichtet	37,50
(5)	Amazone 232980 / 981 neu	295x 60x18	12 Kreisel	19,90
(5)	Amazone 965779 / 781 KE3000	300x 60x18	10 Kreisel	19,90
(5a)	Klappsplint DG086 / 080310	f. Amazone		1,35
(5b)	Bolzen DK032 / 0224200	f. Amazone		1,90
	Breviglieri E0100129 / E0100130	305x100x15		21,90
	Feraboli 07U00039 / 40	320x110x15		28,50
(6)	Kuhn K2500071 / 081	290x110x14	HRB 102 S	14,50
(6)	Kuhn K2502260 / 270	300x110x14	beschichtet	34,90
(6)	Kuhn K2500090 / 100	320x120x16	HR 103DM	16,50
(6)	Kuhn K2502240 / 250	320x120x16	beschichtet	41,90
(7)	Kuhn 52596410 / 510	320x110x26	HR 3002D	25,90
	Kuhn K2507070 / 80	345x110x18	Fast Fit 3	24,50
(6)	Kverneland 46010150 / 151	320x100x15		15,90
(6)	Kverneland 46010150 / 151	320x100x15	beschichtet	49,50
(6)	Kverneland 44010150 / 151	320x100x18		19,90
(6)	Kverneland 44010150 / 151	320x100x18	beschichtet	58,90
(8)	Lemken 3377048 / 3377049	Original	Zirkon 10	48,90
(8)	Lemken 3377050 / 3377051	Original	beschichtet	99,50
(8)	Lemken 3377058 / 3377059	Original	Zirkon 8	45,00
(9)	Lemken 33710010 / 33710011	Original	Zirkon 12	48,50
(9)	Lemken 33710014 / 33710015	Original	beschichtet	99,50
(10)	Maschio 36100366 / 367	Original	Rapido	23,50
(11)	Pöttinger 873.40.220.0 / 225.0	18 mm	mit Loch	25,90
(11)	Pöttinger 873.40.220.0 / 225.0	18 mm	beschichtet	47,90



## Kreislegezzinken passend für



Form	Bezeichnung	Maße mm	Loch-Abstand	€
(1)	Alpego	300x100x12	M16 / 60mm	9,90
(1)	Breviglieri Winkel	300x100x12	M16 / 60mm	9,90
	Carraro 103479	290x 34x23	3 kant	16,90
	Eberhardt 300327 / 328	4 Loch	M12 / 52mm	21,50
	Feraboli 7A48010	270x100x12	M16 / 60mm	16,90
	Feraboli 7A48011	305x105x16	M20 / 60mm	18,90
	Frudent ER + FZ	300x100x12	M16 / 55mm	15,90
(1)	Frudent ERS	310x110x16	M16 / 65mm	22,50
(1)	Howard 182937/38	265x100x15	M14 / 60mm	12,90
(1)	Howard 182939/40	325x100x15	M14 / 60mm	14,50
(1)	Howard 185505/06	320x100x15	M16 / 60mm	14,50
(1)	Howard 185515/16	275x100x15	M16 / 60mm	13,90
(1)	Howard 185535/36	260x100x18	M16 / 60mm	29,90
(1)	Howard 185598/99	300x100x15	M20 / 60mm	24,90
	Kuhn 52503700 gerade	320x 40x18	M16 / 1Loch	11,50
(2)	Kuhn HR101 / 494 / 495	270x110x12	M16 / 68mm	10,90
(2)	Kuhn beschichtet	280x110x13	M16 / 68mm	37,90
(2)	Kuhn 52552411 / 511	360x110x14	M16 / 68mm	18,50
(2)	Kuhn 52539400 / 39500	320x110x16	M16 / 68mm	14,90
(2)	Kuhn 52556400 / 56500	beschichtet	M16 / 68mm	37,50
(2)	Kuhn Schneide gepanzert	Fabr. Gouvy	M16 / 68mm	44,50
(1)	Kverneland 010146 / 020146	280x 90x12	M16 / 50mm	8,50
(3)	Kverneland 070146 / 080146	340x110x18	M18 / 50mm	19,90
(3)	Kverneland 070146 / 080146	beschichtet	M18 / 50mm	44,50
(4)	Lely RH2A konisch	370 lang	M20 Gewinde	13,90
	Lely mit Tropfen verst.	370 lang	M20 Gewinde	13,90
(5)	Lely 1169901110 / 120	345 lang	20 Ø / 1 Loch	17,90
(6)	Lemken 3377012/13 = Standard	Zirkon 6 / 9 / 12	M20 / 70mm	26,90
(6)	Lemken 3377014/15 = beschichtet	Zirkon 3377032/33 6 / 9 / 12	M20 / 70mm	47,50
(6)	Lemken 3377022 / 23	Zirkon 7 + 8	M16 / 73mm	23,90
(6)	Lemken 3377022 / 23	Fabr. Frank	M16 / 73mm	25,90
(6)	beschichtet 3377024 / 25	Zirkon 7 + 8	M16 / 73mm	44,50
(6)	mit Widia 3377024 / 25	Zirkon 7 + 8	M16 / 73mm	64,90
	Maschio HB/HM/HL gerade	330x 60x12	M12 / 44mm	10,90
(1)	Maschio DC / DL / DS	280x 90x12	M16 / 50mm	8,50
(1)	Maschio DC / DL / DS	280x 90x15	M16 / 50mm	10,50
(1)	Maschio DC beschichtet	280x 90x15	M16 / 50mm	26,90
(1)	Maschio DM 36100210/211	300x100x12	M16 / 60mm	9,90
(1)	Maschio DM 36100215/216	300x100x15	M16 / 60mm	12,50
(1)	Maschio DM beschichtet	300x100x15	M16 / 60mm	32,50
	Maschio DM	340x100x15	M16 / 60mm	16,90
	Niemeyer KR2520 / 3020	320 lang	Schaft 32mm	19,90
(1)	Niemeyer 034825 / 034826	330x120x16	M16 / 72mm	24,90
(7)	Rabe KG26 MKE / WMKE	280x 80x15	M14 / 40mm	10,90
(7)	Rabe KG26 beschichtet	ital. Ausf.	M14 / 40mm	32,50
(7)	Rabe KG26 Schneide gepanzert	Fabr. Gouvy	M14 / 40mm	39,50
(7)	Rabe KG30 RKE / PKE / VKE	310x100x15	M16 / 66mm	13,90
(7)	Rabe KG30 rote Ausführung	Fabr. Gouvy	M16 / 66mm	16,90
(7)	Rabe KG30 RKE / PKE / VKE	310x100x18	M16 / 66mm	18,90
(7)	Rabe KG30 beschichtet	ital. Ausf.	M16 / 66mm	34,50
(7)	Rabe KG30 Schneide gepanzert	Fabr. Gouvy	M16 / 66mm	48,50
(7)	Rabe KG41 SKE	300x100x18	M16 / 70mm	19,90
(1)	Rau 0044503 / 504	300x100x15	M16 / 60mm	12,50
(7)	Sauerburger / Schmotzer	310x100x15	M16 / 66mm	13,90
(7)	Sulky 980145 / 146 = Frudent	310x110x16	M16 / 65mm	22,50
(1)	Vogel & Noot VO5590 / 5591	300x100x12	M16 / 60mm	9,90

## Zubehör pass. f. Lemken Zirkon

Bezeichnung	passend für	Zirkon	€
Schraube 16x1,5x37 mm Güte 10.9	3013847	Nr. 8	1,35
Schraube 16x1,5x50 mm Güte 12.9	3013840	Nr. 7	1,20
Schraube 20x1,5x48 mm Güte 10.9	30110256	Nr. 12	4,20
Schraube 20x1,5x52 mm Güte 10.9	30110796	mit Bund	4,60
Schraube 20x1,5x58 mm Güte 10.9	3014235	Nr. 6 + 9	3,90
Bügelmutter M16x1,5	4598601	Nr. 7	8,90
Bügelmutter M16x1,5 flach Nachbau	45910045	Nr. 8	9,90
Bügelmutter M20x1,5	4598602	Nr. 6 + 9	8,90
Bügelmutter M20x1,5	45910044	Nr. 12	12,50
Klappsplint	3119802	Nr. 10	19,90

## Schrauben, Muttern und Zubehör für Kreislege

Bezeichnung	€
Schraube 14x1,5x50 mm Güte 12.9	1,00
Schraube 14x1,5x55 mm Güte 12.9	1,25
Schraube 14x1,5x60 mm Güte 12.9	1,35
Schraube 16x1,5x37 mm Güte 10.9	1,35
Schraube 16x1,5x50 mm Güte 12.9	1,20
Schraube 16x1,5x55 mm Güte 12.9	1,30
Schraube 16x1,5x60 mm Güte 12.9	1,30
Schraube 16x1,5x65 mm Güte 12.9	1,40
Schraube 18x1,5x55 mm Güte 10.9	3,80
Schraube 20x1,5x58 mm Güte 10.9	3,90
Sicherheitsmutter M14x1,5 mit Bund	1,10
Sicherheitsmutter M16x1,5 mit Bund	1,30
Messerschutz Maschio neue Ausf.	4,50
Bügelmutter Maschio LA 50 mm M16	6,90
Bügelmutter Maschio LA 60 mm M16	6,90
Bügelmutter Rabe LA 65 mm M16	11,50

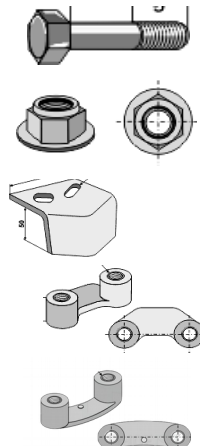

## Hammerschlegel



passend für	Breite	Br. oben	Radius	Loch Ø	€
Agrimaster / OMARV	85 mm	40 mm	100 mm	16,5	10,50
Agrimaster 3001119	150 mm	55 mm	100 mm	20,5	16,90
Berti AP00891	137 mm	40 mm	95 mm	16,5	12,50
Berti MA3922	135 mm	50 mm	95 mm	19,5	16,90
Dragone	100 mm	75 mm	100 mm	18,5	17,50
Fischer gezahnt	155 mm	70 mm	85 mm	16,5	16,90
Fehrenbach EM63	130 mm	50 mm	123 mm	20,5	19,90
HMF Fehrenbach	75 mm	21 mm	95 mm	16,5	12,50
Humus 59091399	150 mm	60 mm	88 mm	16,5	16,50
Humus 45165116D	150 mm	60 mm	88 mm	20,5	14,50
Kuhn 6061700	120 mm	40 mm	110 mm	16,5	13,90
Kuhn 6061699	115 mm	50 mm	180 mm	26,0	19,50
Kuhn 6061900	115 mm	37 mm	105 mm	16,5	14,90
Maschio	150 mm	55 mm	100 mm	20,5	16,90
Maschio 03400410	150 mm	60 mm	90 mm	20,5	14,50
Müthing MU000306	137 mm	40 mm	98 mm	16,5	11,90
Müthing beschichtet	137 mm	40 mm	98 mm	16,5	27,90
OMARV CL00323	120 mm	40 mm	110 mm	16,5	13,90
OMARV CL00325	120 mm	40 mm	110 mm	18,5	14,90
Perfect 13665	110 mm	22 mm	105 mm	20,5	11,50
Perfect 311624	195 mm	74 mm	100 mm	20,5	20,90
Sauerburger	150 mm	60 mm	88 mm	20,5	14,50
Sauerburger Vario	130 mm	70 mm	125 mm	20,5	17,90
Sauerburger beschichtet	130 mm	70 mm	125 mm	20,5	36,90
Seppi/Howard	120 mm	40 mm	110 mm	16,5	13,90
Seppi/Howard	120 mm	40 mm	90 mm	16,5	14,90
Tehnos	120 mm	40 mm	110 mm	20,5	13,50
Willibald gezahnt	155 mm	86 mm	110 mm	20,5	17,50

weitere Fabrikate auf Anfrage lieferbar

## Abstreifbleche für Packerwalzen passend für

passend für: Lochabstand	€
<b>Amazone</b>	
70x90x3 mm 1 Loch	5,90
115x55x3 mm 1 Loch	3,90
115x90x3 mm 1 Loch	3,90
115x90x3 mm beschichtet	14,50
<b>Eberhardt</b>	
150x90x5 mm LA 50	6,90
<b>Feraboli/Frost</b>	
125x90x3 mm LA 45	7,80
140x80x5 mm 1 L. gewölbt	9,50
<b>Frudent</b>	
100x90x3 mm LA 55	5,40
<b>Howard</b>	
95x80x3 mm 180368	6,90
104x80x3 mm LA 42	6,90
<b>Krone</b>	
130x 70x3 mm 1 Loch	5,50
130x100x3 mm 1 Loch	6,20
<b>Kuhn</b>	
140x75x3 mm 1 Loch	3,50
140x75x5 mm 1 Loch	4,95
140x75x3 mm beschichtet	9,80
175x90x5 mm 1 Loch	5,90
FHX 1442D konisch	6,90
<b>Kverneland</b>	
120x82x4 gerade 1 Loch	5,90
120x90x3 gebogen 1 Loch	7,50
160x90x4 gebogen 1 Loch	6,90
160x105 gerade 1 Loch	7,90
<b>Lely</b>	
112x100x3 gerade LA 45	7,90

### Sternabstreifer Kunststoff

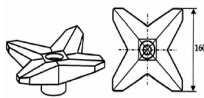

für Spiralwalze € 8,90

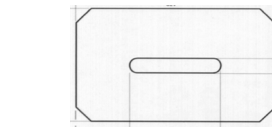

passend für: Lochabstand	€
<b>Lemken</b>	
130x90x3 mm 3492001	4,90
130x90x3 mm beschichtet	14,90
85x55x3 mm 3492011	10,90
94x60x5 mm Widia 3492005	26,90
96x90x5 mm Widia 3492004	38,50
<b>Maschio</b>	
90x95x4 mm 36100499	4,30
112x73x3 mm 24066	5,90
110x95x3 mm LA 42	5,95
110x95x4 mm LA 56	6,50
120x95x4 mm beschichtet	14,90
<b>Niemeyer</b>	
145x70x6 mm 1 Loch	5,90
145x85x6 mm 1 Loch	11,90
<b>Pöttinger - Landsberg</b>	
155x80x5 mm 1 Loch	7,50
170x90x5 mm 1 Loch	7,50
106x100 mm 873.59.129.1	6,90
<b>Rabe</b>	
170x50x4 mm 1 Loch	4,90
170x80x3 mm 1 Loch	3,95
170x80x5 mm 1 Loch	5,90
170x80x10 mm Plastik	7,50
<b>Rau</b>	
120x70x4 mm LA 26	4,90
120x90x4 mm LA 26	6,90
150x60x3 mm 1 Loch	9,80
<b>Vicon</b>	
140x80x5 mm gewölbt	9,50
<b>Schloßschrauben mit Poly-Stop</b>	
8x30 Güte 8.8	0,40
10x30 Güte 8.8	0,65
10x35 Güte 8.8	0,85
12x35 Güte 8.8	0,80

## Schlegelmesser

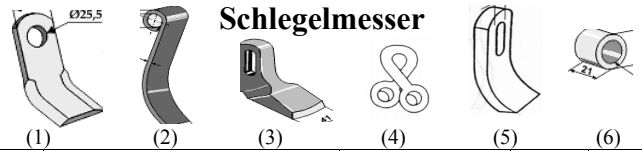

Form	passend für	LxBxDicke	Loch	€
(1)	Agrimaster 3000323	120x 40x 8 mm	20 mm	3,20
(1)	Agrimaster 3000106	150x 60x10 mm	25 mm	5,90
(3)	Bomfort 02.959.01	85x 70x41 mm	16 mm	7,90
(7)	Dücker 1 Loch alte Ausführung	200x120x 8 mm	12 mm	15,90
(8)	Dücker 2 Loch 945000555	200x120x12 mm	14 mm	25,50
(9)	Dücker 2 Loch SMT 13/15	120x120x10 mm	14 mm	19,50
(10)	Dücker 945000901	50x 70x10 mm	13 mm	11,90
(11)	Dücker 2 Loch Bankett	160x120x12 mm		25,90
	Dücker Schraube	14x1,5x25 mm		1,10
(1)	Fehrenbach	204x 60x10 mm	25 mm	5,95
(1)	Claas / Fendt / Ferri 0901003	145x 60x 8 mm	25 mm	4,50
(1)	Fischer	100x 40x10 mm	17 mm	5,20
(1)	Humus 22492376	135x 50x 8 mm	17 mm	5,50
	Humus 302851/951	420x 80x10 mm	24 mm	33,50
(1)	Kuhn 6060004	204x 60x10 mm	26 mm	5,95
(2)	Kuhn Mittelschl. 6061701	195x 34x 8 mm	26 mm	13,50
(1)	Kverneland 6200080	135x 40x10 mm	17 mm	4,20
(10)	Mulag gebogen 142385	150x108x10 mm	27 mm	24,90
(5)	Müthing MU000449	80x50x12 mm		6,90
(4)	Schäkel MU000507	gedreht	14 mm	6,90
(1)	O.M.A.R.V. CL00309	145x 50x10 mm	26 mm	8,90
	Röll 690616/609	220x 80x10 mm	25 mm	15,90
(1)	Sauerburger 0004100402	150x 60x 8 mm	26 mm	6,95
(1)	Sauerburger 700041010026	150x 60x 8 mm	29 mm	4,95
(1)	Sauerburger 0006001943	215x 60x 7 mm	29 mm	7,40
(5)	Votex 45.03.030	100x 35x10 mm	14 mm	2,80
(4)	Votex Schäkel 45.03.061	gedreht	11 mm	6,60
	Votex Schraube mit Mutter	7/16" x 84 mm		1,30
(6)	Votex Buchse 45.03.072	20x 20x12 mm		1,00
(5)	Votex 45.03.190	100x 40x12 mm	17 mm	3,95
(4)	Votex Schäkel 45.03.200	gedreht	14 mm	6,90
	Votex Schraube 45.03.220	14x90 mm		1,95
(6)	Votex Buchse 45.03.210	26x 21x16 mm		1,20

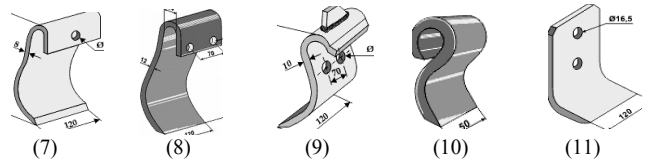

## Rotorzinken / Frähaken / Spargelschläger

Rotorzinken passend für	€
Dutzi 16 mm Loch	31,50
Howard 762406/7 2 Loch 50x12	8,90
Howard 653256/7 2 Loch 60x12	8,90
Howard 653828/9 1 Loch 60x12	9,90
Howard 184215/6 1 Loch 60x12	8,90
Kuhn 523657000 / 58000	14,90
Pegoraro 2 Loch 70x10 / 14,5 Ø	5,90
Pegoraro 1 Loch 70x10 / 16,5 Ø	7,50
Rau 25 4kt.	6,90
Rau 30 4kt.	8,90
Rau 25 4kt. mit Löffel	18,50
Hammerkopfschraube für Rau	1,35



Frähaken passend für	€
Grimme 10061039 Widia	28,90
<b>Spargelschläger 350x50x20mm</b>	
Lochabstand 95mm	29,80
Lochabstand 120mm	29,80

## Fräsmesser passend für

	€
Agria 21098/99 LA 70	4,40
Breviglieri 50x6mm LA 35	5,50
Celli 80x10mm LA 57	12,95
Eberhardt Bogen LA 45	9,50
Horsch 105x10mm LA 75	14,80
Krone 65x 7mm LA 35	6,70
Krone 80x 7mm LA 57	7,90
Maschio 60x 5mm LA 56	5,50
Maschio 60x 6mm LA 44	5,95
Maschio 80x 8mm LA 56	6,90
Rabe 80x 8mm LA 60	12,90
Simon 35x 8mm LA 74	7,50

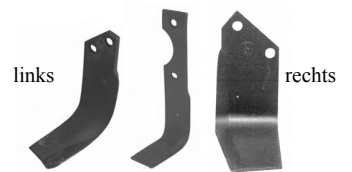

passend für:	€
Howard 9941/9942 / 11 Ø	5,60
Howard 624400/01 / 11 Ø	5,30
Howard 626093/94 / 11 Ø	5,90
Howard 3900/3901 / 13 Ø	5,30
Howard 756784/85 / 16 Ø	9,50
Howard 9862/9863 / 16 Ø	9,50

## Saat-Striegelzinken passend für

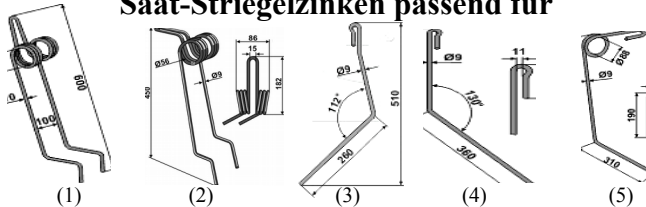

Form	Bezeichnung		Maße	€	
(1)	Accord	495754	doppelt	600 x 8 mm	7,90
(1)	Accord	AC351034	doppelt	600 x 10 mm	10,90
(5)	Accord	AC420859 / 860	links / rechts	285 x 9 mm	9,50
	Amazone	3742300 / 3300	links / rechts	400 x 7 mm	3,20
	Amazone	alte Ausführung	links / rechts	490 x 9 mm	5,20
(3)	Amazone	952588	Außenstriegel rechts	510 x 9 mm	5,90
(3)	Amazone	952591	Außenstriegel links	580 x 9 mm	5,90
(4)	Amazone	952461 neu	links kurz	415 x 9 mm	4,20
(4)	Amazone	952459 neu	rechts lang	580 x 9 mm	5,20
	Amazone	3408200	hinten	360 x 7 mm	4,40
	Amazone	3409200	vorne	290 x 7 mm	3,90
(11)	Fiona			460 x 8 mm	4,50
(5)	Gaspardo	18903640	vorne	350 x 9 mm	6,90
	Gaspardo	18903650	hinten	500 x 9 mm	6,90
(2)	Gaspardo	18904710R	doppelt = <b>Maschio</b>	450 x 9 mm	15,90
(6)	Hassia	033298	vorne	240 x 7 mm	2,95
(7)	Hassia	033299	hinten	270 x 7 mm	2,95
(8)	Hassia	064202 / 064203	links / rechts	400 x 9 mm	4,95
	Hassia	054939 Typ D8	doppelt	350 x 9 mm	7,50
	Hassia =	3537010	vorne	Blattfeder	22,50
	Lemken	3537011	hinten	Blattfeder	22,50
(9)	Horsch	23250303	doppelt	380 x 12 mm	9,90
	Horsch	34217502 M	doppelt	530 x 12 mm	15,90
(6)	Isaria	3142.456M1	vorne	240 x 7 mm	2,95
(7)	Isaria	3142.457M1	hinten	270 x 7 mm	2,95
(5)	Kuhn	530.390.10	vorne	440 x 9 mm	4,60
	Kuhn	530.391.00	hinten	460 x 9 mm	4,60
(10)	Kuhn	K3005740/50	L / R doppelt	500 x 10 mm	10,90
(5)	Kverneland	AC431802/803	links / rechts	530 x 10 mm	7,70
(5)	Lemken	3537056 / 57	links / rechts	310 x 9 mm	7,95
(5)	Lemken	3537054		660 x 10 mm	11,90
(5)	Lemken	3537038 / 39	links / rechts	210 x 7 mm	8,90
(11)	Nordsten	Stegsted		460 x 8 mm	4,50
	Pöttinger	853.85.072.0	kurz	420 x 9 mm	8,50
	Pöttinger	853.85.071.0	lang	530 x 9 mm	9,40
	Rabe	9004.15.22	vorne	270 x 7 mm	5,20
	Rabe	9004.15.23	hinten	485 x 7 mm	6,50
	Rabe	9006.39.50	kurz	430 x 8 mm	7,95
	Rabe	9006.39.51	lang	535 x 8 mm	7,70
	Saphir	69505020189	2-fach	550 x 10 mm	19,90
	Saphir	695921003328	3-fach	550 x 10 mm	19,90

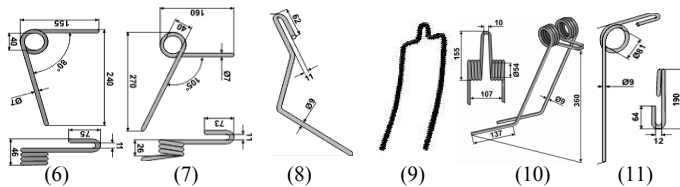

## Luftschlauch grau für Drillmaschine

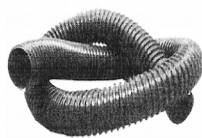

Innen-Ø	per mtr.	ab 50 mtr.
Luftschlauch 30 mm	€ 4,80	€ 4,40
Luftschlauch 32 mm	€ 5,20	€ 4,80
Luftschlauch 35 mm	€ 5,90	€ 5,50
Luftschlauch 38 mm	€ 6,70	€ 5,90
Luftschlauch 40 mm	€ 6,90	€ 6,30

## Hack-Striegelzinken

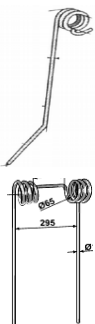

passend für:	Maße	€	ab 200 St.
Einböck	510 x 7,0 mm	4,20	3,80
Einböck	510 x 8,0 mm	4,90	4,50
Hatzenbichler 93111	410 x 5,0 mm	4,20	3,90
Hatzenbichler 9309	415 x 6,0 mm	3,90	3,50
Hatzenbichler 93007	445 x 8,0 mm	4,90	4,50
Hatzenbichler 9312	500 x 7,0 mm	4,40	3,95
Hatzenbichler 9310	500 x 8,0 mm	4,90	4,60
Regent	445 x 8,0 mm	4,40	3,95
Strohstriegel	660 x 13 mm	32,50	
Strohstriegel	760 x 16 mm	48,50	

## Säescheiben und Saatrohre



passend für		Ø	Lochkreis	€	
Accord	495390	glatt	310 mm gewölbt	95 mm	25,90
Accord	495195	Flexscheibe	250 mm gewölbt		36,90
Amazone	3386400 F	glatt	300 mm gerade	70 mm	18,90
Amazone	962292 F	glatt	320 mm gewölbt	70 mm	26,90
Amazone	961301 F	glatt	410 mm gewölbt	104 mm	29,90
Gaspardo	G13825091 F		373 mm x 3,0 mm	75 mm	24,50
Gaspardo	G17722471R		420 mm x 4,0 mm	90 mm	53,90
Horsch	23010201 M	glatt	340 mm	Typ Pronto	20,90
Köckerling	632534	Saatrohr	230 mm lang		32,80
Köckerling	928576	glatt	345 mm x 3,0 mm	60 mm	27,90
Kuhn	K3000060 F		250 mm x 2,5 mm	85 mm	15,90
Lemken	3490010	glatt	350 mm x 3,0 mm	70 mm	22,50
Lager	3198702		40mm Loch 13mm		22,20
Buchse	3173299		20x16x10 mm		2,90
Pöttinger	8504.33.081.0 F		380 mm x 3,5 mm	82 mm	20,90
Väderstad	423573 = 451371		410 mm gerade	104 mm	34,90
Väderstad	423574 F	gezahnt	410 mm gewölbt	104 mm	34,90
Väderstad	444687		430 mm x 5,0 mm	98 mm	39,90
Väderstad	306530/31 F	Saatrohr	432116 / 432117		39,90

## weitere Säescheiben auf Anfrage lieferbar



## Furchenformer pass. f. Amazone

AD 03 Super, AD P2, D9 / 974401 € 9,90

Cirrus, Citan, D9 / 965433/434 mit Widia € 29,50

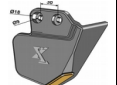

## Drillschare passend für

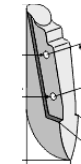

Bezeichnung	Loch-abstand	€	
Accord 494.266	58 mm	7,90	
Amazone 3877300	53 mm	6,80	
Amazone 3668300	92 mm	9,80	
Amazone 956971=954581M	100 mm	11,90	
Fiona 3 L.	290 mm lang	200 mm	19,90
Hassia 31785 = 45549	37 mm	5,80	
Hassia 3378100	55 mm	6,90	
Gaspardo G19203670	81 mm	18,50	
Isaria 3877300	52 mm	6,80	
Isaria Anschweißspitze		3,90	
Kverneland 903028	47 mm	7,95	
Kuhn 170x45x7 2 Loch	45 mm	6,40	
Kuhn R2045111	120 mm	12,80	
Lely Polymat 2100416030	55 mm	10,90	
Lemken 3378100	53 mm	6,90	
Nodet H195	90 mm	10,50	
Nordsten 25085	105 lg.	1 Loch	4,90
Nordsten 36066A	150 lg.	1 Loch	5,90
Nordsten 2148571	160 lg.	1 Loch	5,90
Rabe 90021203	46 mm	10,90	
Reform Semo 99 / 100	60 mm	11,50	

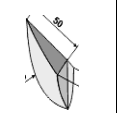
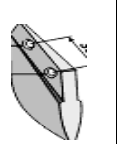
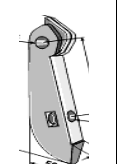
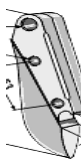
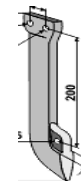

## weitere Drillschare auf Anfrage lieferbar

## Drillschare für Einzelkornsämaschine

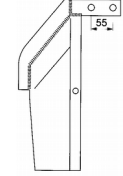
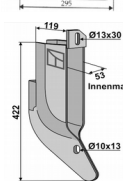
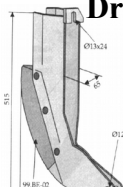

passend für	€
Accord Typ Optima 819670	36,90
Becker Rüben LA55/2L 58383 I	13,50
Becker Mais LA 49/2L 57457 P	19,90
Becker Mais LA 115/3L 58957 I	26,90
Becker Mais kpl. 57071 / 42mm	99,00
Becker Mais kpl. 58967 I	129,00
Becker Mais Düngerschar P 237699	22,50
Becker Düngerscharblech 1-fach	19,50
Becker Düngerscharblech 2-fach	22,50
Gaspardo G19203970R/80L	17,90
Gaspardo 222.703.97 = 19202370	22,50
Gaspardo kpl. 222.703.96 F	129,00
Kleine Maxicorn kpl. 12-500-005 P	189,00
Kleine Maxicorn Gußteil lose	65,00
Kleine Unicorn 15-450-025 Rüben P	58,00
Kleine Unicorn 19-461-025 P	79,90
KL 810187	
Kleine neue Ausf. 190-105 I	79,90
Kuhn - Nodet TBLA 0091D I	34,90

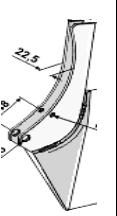
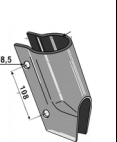
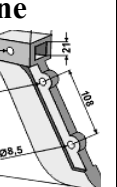

## Eggscheiben passend für

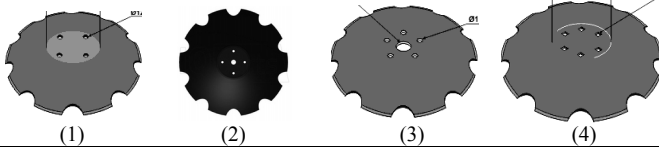

Form	Bezeichnung	Größe	Lochkreis	Org.-Nr.	€
(4)	Agro-Masz 6 Loch	560x4 mm	122 mm		49,50
(1)	Amazone Catros gez.	460x4 mm	110 mm	XL 034	32,90
(1)	Amazone Catros gez.	460x4 mm	120 mm	XL 043	33,50
(1)	Amazone Catros gez.	510x5 mm	120 mm	78201966	44,90
(1)	Amazone Catros verst.	510x6 mm	120 mm	78201966V	51,90
(3)	BBG / Evers 5 Loch	510x6 mm	112 mm	990183	73,90
(1)	Horsch Terrano gez.	460x4 mm	3 Loch	23246102	31,50
(1)	Horsch gezahnt	520x6 mm	5 Loch	28071305	46,50
(1)	Horsch gezahnt	520x6 mm	6 Loch	00311461	59,00
(1)	Horsch gezahnt	620x6 mm	6 Loch	00311103	78,50
(1)	Kerner gezahnt	510x5 mm	125 mm		46,50
(1)	Köckerling 4 Loch	510x5 mm	98 mm	910964	48,50
(1)	Köckerling 4 Loch	620x6 mm	98 mm	912032	69,50
(4)	Kuhn Optimizer gez.	510x5 mm	6 Loch	H2203180	44,90
(4)	Kuhn Optimizer gez.	510x6 mm	6 Loch	H2234350	54,90
(4)	Lemken Heliodor	465x5 mm	6 Loch	3490471	39,50
(1)	Lemken Heliodor	510x5 mm	4 Loch	34910027	44,90
(4)	Lemken Rubin 6 Loch	620x6 mm	130 mm	3490466	59,50
	Lemken Rubin 5 Loch	620x6 mm	155 mm	3490467	59,50
(7)	Lemken Rubin 5 Loch	645x6 mm	155 mm	34910031	67,50
(8)	Lemken Rubin 6 Loch	735x6 mm	195 mm	34910017	109,00
(2)	Mandam	560x4 mm	115 mm	05-02-0127	52,50
(2)	Mandam	610x6 mm	115 mm	05-02-0649	64,50
(1)	Maschio / Gaspardo	510x5 mm	98 mm	65400214R	48,50
(1)	Maschio / Gaspardo I	610x5 mm	110 mm	R18120080	78,00
(1)	Pöttinger Terra Disc	510x4 mm	110 mm	85041023.1	39,50
(1)	Pöttinger Terra Disc	580x5 mm	110 mm	9771030251	49,90
(7)	Unia gezahnt	560 mm	5 Loch		42,50
(9)	Väderstad 495608	430x5 mm	98 mm	444687	39,90
(4)	Vogel & Noot	510x5 mm	98 mm	R2320401	52,50
(4)	Vogel & Noot	560x5 mm	98 mm	R2320403T	52,50
(5)	Eggscheibe	660x6 mm	40 mm	4 kant	69,00
(6)	Scheibe gewellt	510x5 mm	40 mm	4 kant	69,90
(6)	Scheibe gewellt	560x5 mm	40 mm	4 kant	89,90

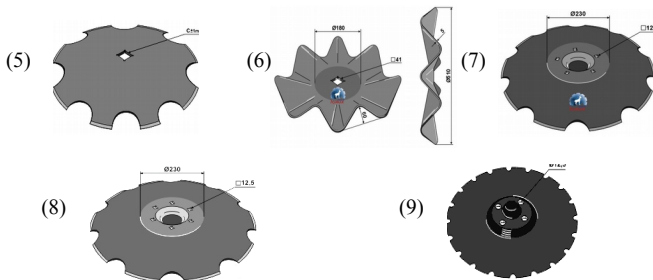

## Cambridgeringe und Sterne passend für

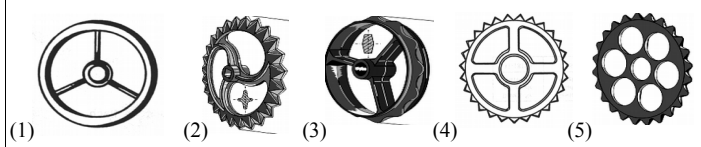

Form	Ringe	Größe	für Wellen	Nabenbr.	Org.-Nr.	€
(1)	Ringe	450 mm	50 mm	100 mm	314-450	57,00
(1)	Ringe	510 mm	50 mm	100 mm	314-500	88,50
(1)	Ringe	510 mm	60 mm	100 mm	314-504	88,50
(2)	Amazone	475 mm	30 mm / 4kt.	50 mm	105021925	55,90
(3)	Dalbo	500 mm	50 mm	100 mm	15168	103,50
(3)	Dalbo	500 mm	60 mm	100 mm	15384	103,50
(3)	Dalbo	550 mm	60 mm	100 mm	15484	119,00
	Güttler	450 mm	50 mm	72 mm	75408000	72,90
(3)	Väderstad	470 mm	55 mm	113 mm	301002	109,00

  

Form	Sterne	Größe	Bohrung	Dicke	Org. #	€
(4)	Sterne	470 mm	118 mm	14 mm	311-470	38,50
(4)	Sterne	530 mm	118 mm	18 mm	311-530	48,90
(5)	Dalbo	530 mm	102 mm	18 mm	15169	57,90
(5)	Dalbo	530 mm	112 mm	18 mm	15385	57,50
(5)	Dalbo	575 mm	114 mm	18 mm	15485	71,50
(4)	Väderstad	480 mm	95 mm	15 mm	301012	34,90

## Zubehör für Scheibeneggen

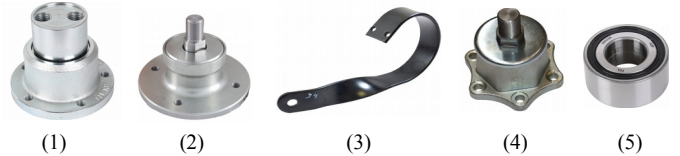

	Bezeichnung	Org.-Nr.	€
(1)	Lager passend für Horsch	28077800	119,00
(2)	Lager passend für Köckerling	910974	119,00
	Lager passend für Kuhn	H2233060	98,00
(2)	Lager passend für Maschio / Gaspardo	F06160015R	119,00
	<b>passend für Lemken:</b>		
(3)	Federholm f. Heliodor 90x13mm links oder rechts	3538734/35	148,00
(4)	Flanschlager für Heliodor kpl. links oder rechts	5554512/13	98,00
(5)	Lager lose passend für Heliodor	3198760	39,00
(6)	Lager für Rubin 5 Loch kpl. links oder rechts	55510014/15	85,00
(7)	Lager für Rubin 6 Loch kpl. links oder rechts	4550300/01	98,00
(8)	Lager lose für Rubin	3198750	39,90
(9)	Kassetendichtung	3238301	23,90

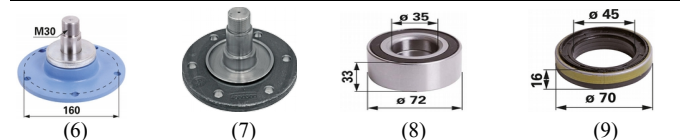

## Kugellager 2RS



Nr.	Ø I/A/Breite	€
6003	17x35x10 mm	1,90
6004	20x42x12 mm	2,30
6204	20x47x14 mm	2,50
6304	20x52x15 mm	2,90
6005	25x47x12 mm	2,60
6205	25x52x15 mm	2,90
6305	25x62x17 mm	4,60
6006	30x55x13 mm	3,50
6206	30x62x16 mm	3,90
6306	30x72x19 mm	6,50
6007	35x62x14 mm	3,60
6207	35x72x17 mm	5,50
6307	35x80x21 mm	8,70
6008	40x68x15 mm	4,50
6208	40x80x18 mm	7,90
6308	40x90x23 mm	11,50
6009	45x75x16 mm	6,40
6209	45x85x19 mm	8,50
6010	50x80x16 mm	5,90
6210	50x90x20 mm	9,50

## Rübenroderschare passend für

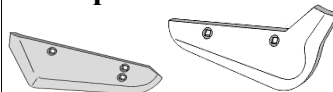

	€
<b>Holmer</b> 400 lg.	18,50
<b>Ropa</b>	18,50
<b>Kleine</b> 5000/2	22,90
<b>Stoll</b> 340 lg. 3 Loch	26,90

## Flanschlager UCF 4 Loch



Ø	L x B	Lochab.	€
25	95x 95mm	70mm	8,90
30	108x108mm	83mm	11,80
35	117x117mm	92mm	14,90
40	130x130mm	102mm	19,90
45	137x137mm	105mm	19,90
50	143x143mm	111mm	24,90

## Messer für Spatenrolleggen

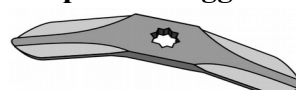

passend für:	Ø	€
Hankmo + Ommé	30 mm	24,50
Horsch 310157/58	26 mm	24,50
Sampo + Tume	26 mm	24,50
Rabe SSG-37		27,50
Rabe SSG-400		24,50

## Stehlager UCP 2 Loch



Ø	L x B	Lochab.	€
25	140x48mm	99mm	8,90
30	165x48mm	117mm	13,50
35	167x48mm	130mm	16,90
40	184x54mm	137mm	17,90
45	190x54mm	146mm	20,90
50	206x60mm	157mm	24,50

## Rollspatzenmesser passend für Bomford

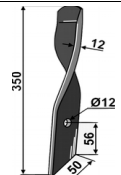

Dyna-Drive	€
350 x 40 x 12 mm	€
0396109 links   0396110 rechts	15,90
<b>Dyna-Drive Jumbo</b>	
350 x 50 x 12 mm	€
0694901 links   0694902 rechts	13,50

## Flanschlager UCFL



Ø	Lochab.	€	
25	130x 68mm	9,50	
30	148x 80mm	12,50	
35	161x 90mm	15,90	
40	175x100mm	18,50	
45	188x108mm	148mm	20,90
50	197x143mm	151mm	24,90

## Kreiselheuerzinken



passend für	Typ	€
Claas 902.482 / 483	W 450 - W 650 / bis '83	6,90
Claas 902.344.2	W 360 - WAS 730	6,90
Claas 956.815.1	Volto 5 W. (ab 98) 9,5mm	8,90
Claas 956.907.0	Volto 5 W. (ab 98) 10,5mm	10,90
Fahr 06229776/06580391	KH2-KH6 rot/weiß (alt)	6,90
Fahr 06580456	KH4S / KH20 - KH60	5,90
Fahr 0656.5574	KH 500 DN Hydro	6,95
Fahr 1660.7564	innen 63 mm Ø / COM 5521	10,90
Fahr 1662.0057 I	innen 49 mm Ø	9,50
Fella 487.133/34	TH 4S/TH 330 - TH 460	7,50
Fella 487.922 = 150862	TH 410-700 Hydro	5,50
Krone 153.014.1/15.1	KW 4.40/4 links + rechts	8,90
Krone 264.081.0	KW 5.50 KW 6.40 weiß	10,90
Kuhn 585.052.14	GF alte Ausführung	8,60
Kuhn 585.619.00	GF 22/440/452/671	8,90
Kuhn 576.090.00	GF 4000/5000	6,50
Kuhn 587.40.600 / 700	GF 8501 links + rechts	6,95
Kverneland 674600 / 274100		13,90
Niemeyer 600011 / 12	HR 300/702 10501/2	8,90
Niemeyer 600032 / 33	HR 751 - HR 771	8,90
Niemeyer 600056 / 57	HR 771 - HR 1101	12,00
Niemeyer 600061 / 62	HR 771 - HR 1101 ab 1996	9,90
Pöttinger 436.140	Hit 30-54 bis Bj. 90	5,90
Pöttinger 436.145	Hit Bj. 92-99	7,50
Pöttinger 436.155 / 56	neu links + rechts	9,90
SIP 153.910.405	430 - 680	10,90
Stoll 0.60.87.70	Z 400 - Z 700	7,90
Stoll 0.63.52.40	Z 450 - Z 800 Hydro	7,90
Stoll 0.67.37.41 / 42	Z 685 Pro links + rechts	8,95
PZ-Zweegers PZ 339/40	Fanex 400-730 links + rechts	7,90
Zinkenverlustsicherung	Sparex Drahtseil 10 St. Pack.	35,90
Zinkenverlustsicherung	Original Kunststoff gelb	4,90
Fahr 0656.5406	Original für Fahr Hydro	7,90



## Kreiselschwaderzinken

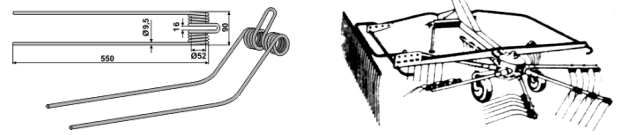

passend für	Typ	€
Claas 902.083 475 lg.	WS 280 - WSDS 370/8 Ø	7,50
Claas 953.629.0 525 lg.	WS 660 S/ 760 Liner	8,50
Claas 955.483.0 595 lg.	WS 390 S/WS 470 S	7,90
Claas 955.710.0 595 lg.	Liner 1550 TWIN, 3000	8,90
Fahr 06580259	KS 60/80D	6,60
Fahr 06231509	KS 85/90/200/230	6,60
Fahr 1650.2737/4333	KS 1.30/1.50	8,90
Fahr 1650.2739/4331	KS 1.70	8,50
Fahr 1660.0387	KS 3.33/3.60/70	7,95
Fahr 1660.6394	SWM 3221-11041	9,50
Fella 491.774	TS 210 - TS 325 8 Ø	9,80
Fella 497.032=160.313	TS 315 RDS	8,90
Fella 491.989	TS 315/325 RDF	12,80
Fella 160.111	TS 425-781/1600 Hydro	7,90
Fella 162.058	TS 670K / 1400 / 1600	12,90
Krone 153.662.0/233.2	KS 3.30/3.80/4.20	12,90
Krone 153.661.0/646.1	KS 6.50-7.60/ 24 DUO	12,90
Krone 265.0100/120	KS 6.50-7.60/ 24 DUO	11,90
Krone 268.405.0	Swadro 800 / 900 / 1400 2W	7,90
Krone 20.042.839.0	ab Bj. 2010 / 3 Windungen	12,90
Kuhn 575.020.00	GA 200 - GA 300 490 lg.	7,95
Kuhn 577.017.00	GA 230 - GA 402 510 lg.	8,90
Kuhn 577.202.00	GA 381/GA 7301	9,50
Kuhn 576.440.10	GRS 25 neu	9,50
Kuhn 575.625.00	GA 3501 - GA 4511	9,50
Kuhn 577.637.00	GA 6000/7000/7822/15031	10,90
Niemeyer 600013/=12100	RS 28 / RS 330 D	8,90
Niemeyer 600034	RS 430 D/500 D 10 mm	8,90
Niemeyer 600040	RS 700 D - RS 820 D	9,90
Niemeyer 600063	Twin 470 / Länge 590 mm	16,90
Niemeyer 600064	Twin 345 / Länge 520 mm	13,90
Pöttinger 436.028= 436.141	SK 272/322	8,50
Pöttinger 436.030 / 595 lg.	TOP 42N/420N/421N	8,90
Pöttinger 436.031 / 585 lg.	TOP 420N/660/SK261	8,50
Pöttinger 436.033 / 550 lg.	TOP 280 - TOP 801	7,50
Pöttinger 436.034 / 635 lg.	TOP 852/972/1252	9,50
SIP/Unifarm 153.932.908	Star 280-410	10,90
Stoll 0.60.68.11	R 231/282/311/331	8,50
Stoll 0.62.18.11	R 285 DS - R 655 DS / 1405	8,50
Stoll 0.65.43.40	R 460 - R 465 DS	11,90

**weitere Fabrikate auf Anfrage lieferbar**

## Heumaschinenreifen

Ø	Größe	PR	Reifen	Schlauch
260	2.60x85	2 PR	€ 9,90	€ 7,20
260	3.00x4	4 PR	€ 13,90	€ 7,20
340	3.50x6	4T7	€ 24,90	€ 8,50
340	3.50x8	4T7	€ 26,50	€ 8,50
300	4.00x4	4T7	€ 19,90	€ 6,90
400	4.00x8	4T7	€ 32,90	€ 6,90
400	4.00x100	4 PR	€ 9,90	€ 6,90
360	15x6.00-6	4 PR	€ 25,90	€ 10,90
360	15x6.00-6	10 PR	€ 39,50	€ 10,90
420	16x6.50-8	4 PR	€ 32,50	€ 10,90
420	16x6.50-8	6 PR	€ 37,50	€ 10,90
	18x8.50-8	4 PR	€ 44,50	€ 14,90
	18x8.50-8	10 PR	€ 76,50	€ 14,90

**Heumaschinenräder luftbereift m. Kugellager**

15x6.00-6	Bohrung 25 Ø	4 PR	€ 79,50
15x6.00-6	Bohrung 25 Ø	10 PR	€ 89,00
16x6.50-8	Bohrung 25 Ø	6 PR	€ 89,00
16x6.50-8	Bohrung 25 Ø	10 PR	€ 119,00
18x8.50-8	Bohrung 25 Ø	6 PR	€ 149,00
18x8.50-8	Bohrung 30 Ø	6 PR	€ 139,00

## Blechräder für Landmaschinen mit Kugellager

Rad - Ø	Breite	Bohrung	€
250	100 mm	25 mm	52,50
280	80 mm	25 mm	59,00
300	100 mm	25 mm	76,50
400	100 mm	25 mm	115,00
400	150 mm	30 oder 35 mm	129,00
500	150 mm	30 oder 35 mm	169,00

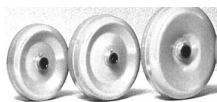

## Mähmesserklingen und Finger

Mähmesserklingen:	€
DIN 75 gez.	1,00
DIN 80 gez.	1,00
GB 2730 glatt = 5802.009.01	2,80
GB 2731 glatt = 5802.011.01 mit Pilz	4,50
GB 2632 Endklinge	6,50
Bidux 5802 553 01 Org.	3,25
Bidux 5802 553 91 Org. mit Pilz	5,60
Mörtl N 36/5 gezahnt	1,30
Mörtl N 336 gezahnt	1,50
Doppelfinger Busatis GB22 = GB30	32,50
Einzelfinger Mörtl F19 E-F	24,90



## Schutzplane für Kreiselmähwerk

schwere Qualität, gelb oder grau  
850 gr./m<sup>2</sup> mit Saum  
Trevira-Gewebe  
2-seitig beschichtet,  
47cm hoch/30mm Saum

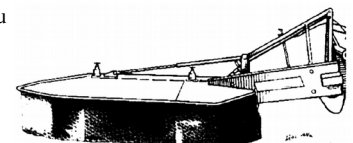

lose per mtr. € 19,80

# Kreiselmäherklingen

Made in Germany



passend für			
Claas	Loch	LxBxS	€
904.177/78.8	19 Ø	105x48x3	1,10
949.241/42	19 Ø	105x48x4	1,25
952.042/43	19 Ø	115x48x4	1,30
<b>Fahr</b>			
96 gerade	19 Ø	96x40x3	0,65
98 gerade	19 Ø	98x40x3	0,80
96 gekröpft	19 Ø	96x40x3	0,80
1650-3464/3465	19 Ø	96x48x4	1,20
0656.1546/1547	19 Ø	96x40x3	0,95
<b>Fella</b>			
121.712/13	19 Ø	98x48x4	1,10
140.692/93	19 Ø	102x48x4	1,35
122.329/30	19 Ø	106x48x4	1,35
123.706/07	19 Ø	112x48x4	1,20
134.308/09	19 Ø	112x48x4	1,20
133.074/75	19 Ø	118x47x4	1,35
111.724/25	18,5 Ø	120x48x4	1,35
<b>JF</b>			
1380-0014/15	19 Ø	114x47x4	1,45
1380-0025	19 Ø	97x50x4	1,25
1380-0027	19 Ø	114x50x4	1,90
1380-0028/29	21 x 28	134x55x4	3,95
<b>Krone</b>			
139.800	gewölbt	117x55x4	3,95
139.888/89	19 Ø	112x48x4	1,25
144.825/26	19 Ø	90x50x4	1,25
146.690/91	19 Ø	96x50x4	1,15
<b>Kuhn</b>			
561512/513.10	16 Ø	95x45x3,5	1,35
564512/513.00	18 Ø	123x45x4	1,25
559032/33.10	18 Ø	107x45x4	1,15
K6801410/20	21 Ø	105x48x4	1,35
K6804710/20	21 Ø	116x48x4	1,55
Z1200070/80	19 Ø	96x48x4	1,20
<b>Kverneland</b>			
XD 570-3	18 Ø	107x50x4	1,15
56.110.500	20 x 23	131x50x4	2,25
<b>Mörtl</b>			
T 673	23 Ø	94x48x3	1,10
T 684	23 Ø	100x48x4	1,50
<b>Niemeyer</b>			
570.409/10	19 Ø	94x48x3	1,10
570.418/19	19 Ø	100x48x3	1,20
570.444/45	19 Ø	106x48x4	1,30
<b>Pöttinger</b>			
434.962/63	21 Ø	116x48x4	1,95
434.969/70	21 Ø	112x48x4	1,30
434.975/76	21 Ø	120x48x4	1,60
434.977/78	21 Ø	100x48x4	1,30
434.979/80	19 Ø	96x48x3	1,10
434.983/84	19 Ø	100x48x3	1,15
434.985/86	19 Ø	108x47x4	1,20
434.988/89	19 Ø	120x48x4	1,35
434.997/98	19 Ø	96x40x3	0,95
<b>Samasz</b>		115x47x4	1,30
<b>SIP</b>			
745032010/20	19 Ø	112x48x4	1,20
<b>Stoll</b>			
1115410/20	19 Ø	97x47x4	1,25
1122350/60	19 Ø	114x47x4	1,45
<b>Taarup</b>			
56.110.300	gewölbt	128x50x4	2,10
56.110.400/900	20 x 23	126x48x4	1,40
<b>Tschechien</b>		106x47x3	1,60
<b>Vicon = Lely</b>			
902.58699/700	18,5 Ø	120x48x4	1,30
9112700032/43	18,5 Ø	120x48x4	1,30
<b>Welger</b>			
9821516/17	21 Ø	120x50x4	1,40
<b>Zweggers</b>			
CM 15	21 Ø	105x46x3	0,90
CM 120 gekr.	21 Ø	105x46x3	0,90
CM 137/138	21 Ø	106x47x3	1,60
TF 70/71	19 Ø	94x49x3	0,95

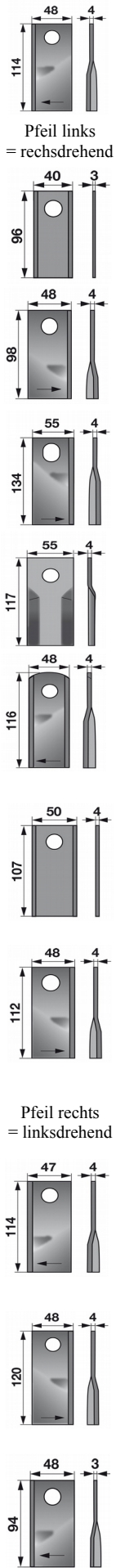

# Gleitkufen / Mähscheiben / Gleitteller

Gleitkufe passend für		€
Claas 9333760 P	Disco 8500 / Cougar 1400	159,00
Claas 1384660 F	Disco 8500 / Cougar 1400	159,00
Claas 9333891 P	Disco 210 / 230 / 250	159,00
Claas 9354632 F	Disco 260 C / 300 C	169,00
Claas 9389660		
951.030.1 / 935.039.1	145 mm breit	34,90
Claas 001321.0690.0	175 mm breit	44,90
Krone 253.480.1 F	Lochabstand 120 mm	69,90
Krone 150.269.1	Big M	95,00
Kuhn 56190600 P	GMD 44/55/66/77	79,00
Kuhn 56801400 P	GMD 400-700	69,90
Kuhn 56809300 P	GMD 702,802,902	94,00
Kuhn 56808510 I	Verschleißbrücke 120 br.	24,50
Kuhn 56808610 F	Verschleißbrücke 155 br.	29,90
Kuhn K6800121	GMD 4010/4410	139,00
Kuhn K6800123	PC 3160/3560	109,00
Lely 4-1220-19620	330 x 140 x 8 mm	41,50
Pöttinger mitte	397.60.170.1 Frank	28,90
Pöttinger rechts	378.60.170.0 Frank	44,50
Pöttinger links	378.60.171.1 Frank	44,50
Pöttinger mitte	397.60.240.0 Frank	54,50
Pöttinger rechts	397.60.243.0 Frank	54,50
Pöttinger links	397.60.245.0 Frank	54,50
Mähscheibe passend für		€
Claas 9523400 P	Disco / Cougar 1400	169,00
Krone 2535312 F	Easy Cut	79,50
Kuhn 56200700 A	GMD 44 / 55 / 66	119,00
Lely 4-1249-1440 A		109,00
Pöttinger 397601502	Novacut	159,00
Gleitteller passend für		€
Claas 947442	Corto 270-290F 617 Ø	189,00
Claas 949272	Corto 270F innen 530 Ø	189,00
Fahr 600363	KM 22 770 Ø	138,00
Fahr 600384	KM 24 880 Ø	189,00
Fahr 420385	KM 25 1000 Ø	298,00
Fella 140507 A	KM 265 F / 270 F 580 Ø	159,00
Pöttinger	TM 2S/CAT 185 880 Ø	189,00
Pöttinger	TM 3/CAT 210F 1000 Ø	198,00
Pöttinger 412155	CAT 270F 620 Ø	149,00
PZ 600808 A	CM 185 870 Ø	185,00
PZ 405210	CM 211+212 1000 Ø	345,00
Stützteller passend für		€
Fahr 420386	KM25/0658-0805 475 Ø	98,00
Fella 496097N	KM167 / KM187 550 Ø	82,50
Fella 140177N	KM 270 F / 300 M 356 Ø	49,50
Pöttinger	348650100 F 354 Ø	99,00

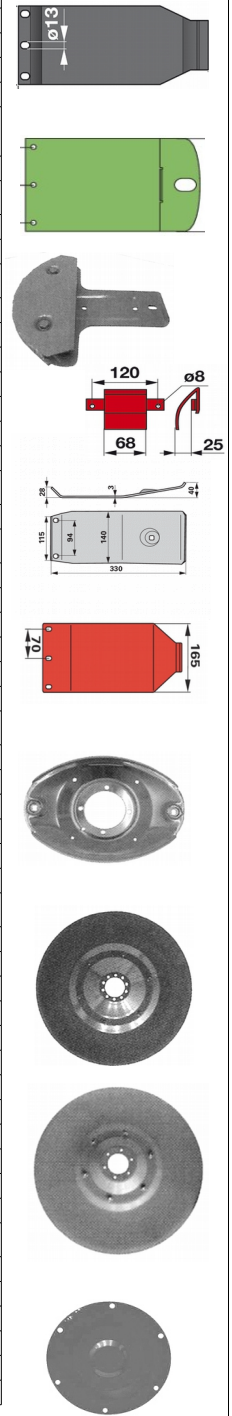





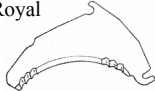
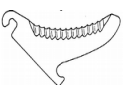
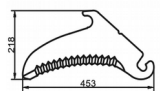
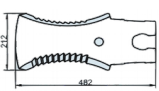
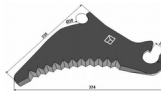
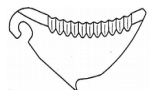
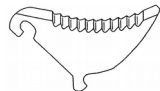

# Befestigungen und Messerhalter

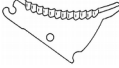
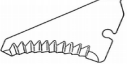

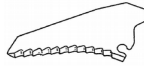

Claas / Krone	Claas	Claas (innen)	Kuhn
Disco 952346.2	Disco	947.427.1 € 17,50	561-158-00K M12
Krone 1377.26-26	938597.0	950.951.0 € 18,90	Scheibenmäherwerk
€ 4,20	€ 69,00	ohne 2. Bolzen	€ 2,30
Fella	Fahr	Pöttinger	PZ - Vicon
426887	KM22 / KM25	434.112 € 20,90	
Schraube + Mutter	1-1017-010.550	434.121 € 18,90	PZ 243 € 15,50
€ 6,90	€ 13,90	434.125 € 18,90	PZ 250 € 16,90

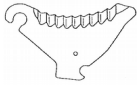
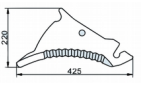

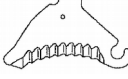
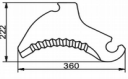
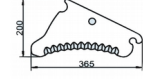
# Messer für Ladewagen und Rundballenpressen - Made in Germany - passend für :

<b>Bergmann</b> Royal  B2.00777 per Stück € 33,90 ab 20 Stück € 30,90	<b>Claas Ladewagenmesser</b>			<b>Claas Pressenmesser</b>		
	 971.303.0 per Stück € 27,90 ab 20 St. € 25,90	 1325288.0 per Stück € 29,90 ab 20 St. € 27,90	 1391830.0 per Stück € 39,90 ab 20 St. € 36,90	 2697448.0 per Stück € 28,90 ab 20 Stück € 25,90	 837.779.0 per Stück € 26,90 ab 20 Stück € 23,90	 841.599.1 per Stück € 27,90 ab 20 Stück € 24,90

<b>Fahr</b> Ladewagen  1-1432-170-100-00 per Stück € 26,90 ab 20 St. € 23,90	<b>Fahr</b> Presse  1661.3168 per Stück € 25,90 ab 20 St. € 22,90	<b>Krone</b> titan, kurz  2.332.960.0 per Stück € 33,90 ab 20 St. € 30,90	<b>Krone</b> titan, lang  2.332.970.0 per Stück € 36,50 ab 20 St. € 33,50	<b>AX / MX</b> 2005.41140  2005.11990 per Stück € 28,90 ab 20 St. € 26,90	<b>AX / MX</b> neu – ohne Kerbe  2005.96081 per Stück € 28,90 ab 20 St. € 26,90	<b>XXL / ZX</b> 20 050 469.0  333.786.0 / 334.899.0 per Stück € 35,50 ab 20 St. € 32,50	<b>Krone</b> turbo  2.347.216.7 per Stück € 29,50 ab 20 St. € 26,90
--	---	---	---	---	--	---	---

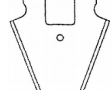

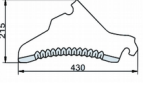
<b>Pressenmesser passend für Krone</b>					<b>John Deere</b>  CC 52821 per Stück € 27,80 ab 20 St. € 24,80	<b>Kuhn</b>  Z4533760 per Stück € 29,50 ab 20 St. € 27,50
<b>Combi, Round, Vario</b>  279.349.0=277.761.0 per Stück € 27,50 ab 20 St. € 24,90	<b>Bigpack 890/1270</b>  2007.15720 per Stück € 27,50 ab 20 St. € 24,50	 2006.11142 per Stück € 27,50 ab 20 St. € 24,50	 2027.33792 per Stück € 29,90 ab 20 St. € 26,90	 285.777.0 per Stück € 29,90 ab 20 St. € 26,90		

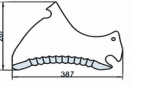
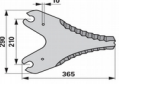
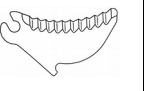
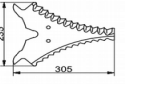
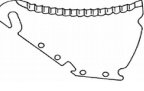
<b>Lely Tigo</b> Agro-Silobull  01-144-401 per Stück € 28,90 ab 20 St. € 26,90	<b>Mengele</b>  02-067-987 per Stück € 29,90 ab 20 St. € 27,50	<b>Mengele</b> Garant  02-101-415 per Stück € 28,90 ab 20 St. € 25,90	<b>Mengele</b> Walzeneinzug  02-112-586 per Stück € 26,90 ab 20 St. € 24,90	<b>Rotobull</b> Rotant 740/745  01-129-690 per Stück € 25,90 ab 20 St. € 23,90	<b>Schuitemaker</b>  433102 433124 433999 per Stück € 20,90 ab 20 St. € 19,50
--	---	---	---	--	--

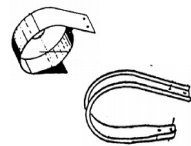
<b>Pöttinger</b> 40 cm lang  434.100 per Stück € 22,90 ab 20 St. € 20,90	<b>Pöttinger</b> 43 cm lang  434.126 / 430 mm per Stück € 27,90 ab 20 St. € 24,90	<b>Pöttinger</b> Jumbo / Torro  434.135 per Stück € 30,50 ab 20 St. € 27,50	<b>Pöttinger</b>  434.147 per Stück € 33,90 ab 20 St. € 29,90	<b>Pöttinger</b>  434.152 per Stück € 34,90 ab 20 St. € 31,90	<b>CNH</b> Pressenmesser  84056505 per Stück € 27,50 ab 20 St. € 24,50	<b>Strautmann</b> Giga / Mega  504.36.501/507 per Stück € 32,90 ab 20 St. € 29,90	<b>Strautmann</b> Super  410.18.500 per Stück € 48,90 ab 20 St. € 43,90
--	---	---	--	--	---	---	---

<b>Abstreifbleche für Ladewagen</b>	<b>passend für:</b>	<b>Org.-Nr.</b>	<b>€</b>	
	Bergmann Royal	2.830.01	23,50	
	Krone Titan	938150.1	23,50	
	Mengele Quadro	2046758	19,90	
	Mengele Rotant	2127737	26,90	
	Pöttinger	126500280	19,50	
Siloprofi	122500580	24,50		

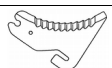
<b>Topfscheibe</b> 	200x80mm 30 Ø Loch € 99,00 35 Ø Loch € 115,00
--	---

<b>Welger</b>	
	
0982.21.04.00	0982.21.09.00
p. Stück € 30,90	p. Stück € 26,90
ab 20 St € 28,90	ab 20 St € 24,50



## Pick-up-Zinken für Feldhäcksler, Ladewagen und Pressen passend für:



passend für:	Typ	€
Bergmann B02055426	Royal	5,50
Claas 807.297.1	Rollant 44/62 / Öse 8mm	3,60
Claas 821.421.1	Rollant 42-66 / Öse 10mm	3,30
Claas 918.238.0	Quadrant / Rollant 250 / Variant	3,30
Claas 918.239.0 (5,5 mm)	Jaguar	3,50
Claas 986.290.0 (6,5 mm)	Cargos / Jaguar / Quantum	4,40
Fahr 1.1417.160.122.0	WE 322 - WE 427	2,90
Fahr Presse 1661.8868	Großballenpresse	3,10
Hagedorn 2.420.05	Stille, Unsinn	2,90
Krone 938040	KR 120,150,155	3,50
Krone 938053	TL 2200 - 4000	3,70
Krone 938148	Turbo / Titan 90 / XXL	3,00
Krone 938158	KR 130,160	2,90
Krone 938275	KR 10-16 = 278.552.0	3,40
Krone 938.436.0	ungesteuerte Pick-up	4,80
Krone 2700.1457.0	Combiprima	3,80
Krone 2700.5012.0	AX/MX/ZX	3,80



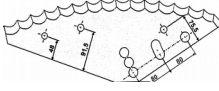
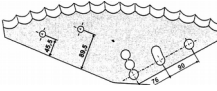
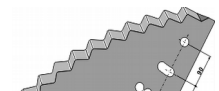

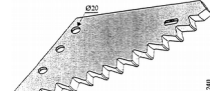
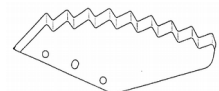

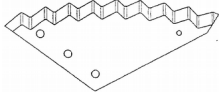
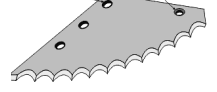
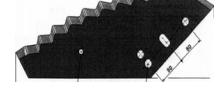
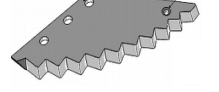

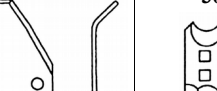

passend für:	Typ	€
Kemper 2.420.05	Ladomat A,B,C	2,90
Landsberg 1262320	Luxor FH 07052	3,60
Mengele 02-080-423	LW 280 - LW 370	3,40
Mengele 02-049-217	LW 210- LW 370 Quadro	3,40
Mengele 03-035-653	LW 32 - LW 370	3,10
Mengele 02-128-199	Rotant ab Bj. 1996	3,70
New Holland 80683310	D800 - D2000 Presse	5,80
Pöttinger 436.151	Torro, Jumbo	3,50
Pöttinger 436.019 = 138	Trend Top 1,2,3	3,30
Pöttinger 436.024	LW 14/ # 3300510	3,40
Welger 0940.52.21.00	RP 120-180 (0343.12)	3,10
Welger 0940.53.02.00	WSA 350/450 (0343.38)	4,20
Welger 0940.52.25.00	RP 12 - RP 15	3,20
Welger 0940.52.29.00	RP 200	3,50
Strautmann 870.057.03	Super Vitese 145 mm	3,00
Strautmann 870.106.30	Super Vitese 160 mm	3,20

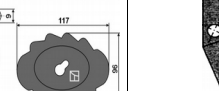
# Messer für Futtermischwagen passend für



<b>AGM / Mayer-Siloking</b> 1050030 / 70-271 alte Ausführung  545x190x5mm LA 80 / 19 Ø € 49,90	<b>AGM / Mayer-Siloking</b> 1050254 / 70-266  545x190x5mm LA 76 + LA 90 € 49,90 dto. beschichtet € 76,50	<b>AGM / Mayer-Siloking</b> 1050622 / 70-330 neue Ausführung  500x250x8mm LA 76 + LA 90 € 40,90 dto. beschichtet € 69,50	<b>Faresin 512001550</b> General-Mix  grob gezahnt 535x220x6mm Standard € 49,50 dto. beschichtet € 58,50	<b>Frasto / Walker</b> van Lengerich/R.M.H. R/L # 70-230  557x220x6 mm LA 80 / 20 Ø € 39,50 dto. beschichtet € 59,90	<b>Kuhn A530.2190</b> 385x160x8 mm € 43,50 beschichtet € 69,90  <b>Kuhn A530.3620</b> 515x195x10mm € 49,50 beschichtet € 89,50
---	--	---	--	---	---

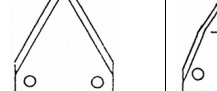
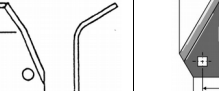

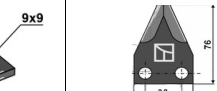
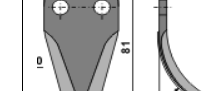
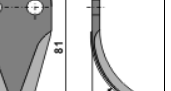

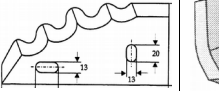
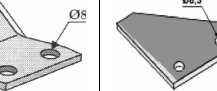
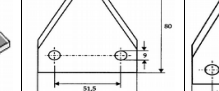
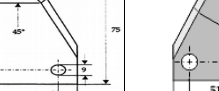
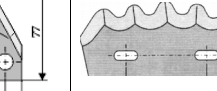
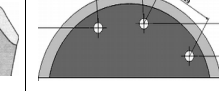
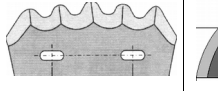
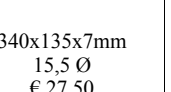
<b>Strautmann 609.03.500</b> <b>Strautmann 609.03.508</b>  500x220x8mm Standard € 49,50 beschichtet € 64,50	<b>Strautmann 609.03.509</b> 560 x 220 mm  LA 80 / 19 Ø 8 mm / 70-570 € 54,50	<b>JF-Stoll 8-11380-0040</b> 70-331 / LA 80 / 17 Ø  550x190x8 mm beschichtet € 79,50 Unterlage f. dto. € 33,90	<b>JF-Stoll / Trioliet 31639</b> 70-252  550x190x6 mm LA 80 / 19,5 Ø € 59,50	<b>JF-Stoll / Trioliet 31841</b> 70-251  390x160x9 mm LA 160 / 17 Ø € 39,50 dto. beschichtet € 59,00	<b>JF-Stoll / 1380-0034</b> 70-326  390x160x8 mm LA 160 / 17 Ø € 43,50
--	---	--	---	--	--

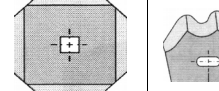
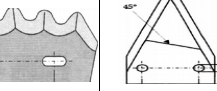
<b>Faresin gerade</b> 88x76mm  LA 52 / 8,5 Ø 3 mm € 3,20 4 mm € 4,50	<b>Faresin gebogen</b> 88x76mm  LA 52 / 8,5 Ø 3 mm € 4,50 4 mm € 5,90	<b>Faresin</b> 308460000 308408750  links oder rechts 140x102x6 mm € 16,90	<b>Frasto</b> 16800139 / 16800171  117x96x5mm beschichtet € 13,90	<b>Frasto</b> R/L # 180/181  80x40x5mm LA 32 / 6,5 Ø € 3,95	<b>Frasto/Himmel #121</b> Marmix/Walker  95x5mm glatt 10,5 Ø 4kt. € 4,95	<b>Frasto/Himmel #168</b> Marmix/Seko  95x5mm gezahnt 10,5 Ø 4kt. € 5,90
---	---	---	--	---	--	--

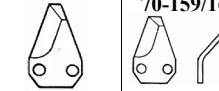
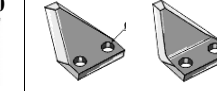
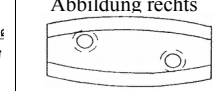
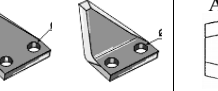
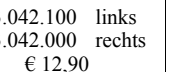
<b>Keenan beschichtet</b> 701358/701359 233x100x5mm € 28,00  703956 / 703957 207x85x6mm € 33,80	<b>Kuhn/R.M.H.</b> gerade 76 x 80 mm  LA 52 / 6,5 Ø 3 mm € 2,70 4 mm € 3,40	<b>Kuhn/Audureau</b> gebogen 3868101  76x67x3mm LA 52 / 6,5 Ø € 3,95	<b>Kuhn</b> gerade A7153021  80x95x4mm LA 51 / 9,0 Ø € 3,40	<b>Kuhn</b> gebogen A7153023  80x95x4mm LA 51 / 9,0 Ø € 5,40	<b>Kverneland/Mayer</b> gerade beschichtet #70-410  76x50x5mm LA 30 / 8 Ø € 12,90	<b>Mayer gebogen</b> 70-325 beschichtet  81x50x5mm LA 28 / 10 Ø € 21,90
--	---	--	--	--	--	---

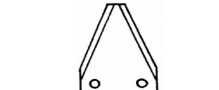
<b>Himmel rechts #110 -</b> <b>Himmel links #109 +</b>  Abbildung rechts 195x90x5mm Standard € 12,50 beschichtet € 22,90	<b>Himmel #112</b> gebogen 55°  76x66x3mm LA 51 / 8 Ø € 3,70	<b>Marchner</b> #70-264  83x70x4,5mm LA 41 / 8 Ø € 6,80	<b>Himmel/Marmix</b> gerade #143  76x80x3mm LA 51 / 9 Ø € 2,50	<b>Marmix # 145</b> gebogen 45°  76x75x3mm LA 51 / 9 Ø € 3,95	<b>Marmix #205/206</b> R/L gebogen 35°  76x77x3mm LA 51 / 9 Ø € 3,70	<b>Marmix #114</b>  195x5mm LA 96 € 13,90	<b>Marmix #236</b> halbrund  340x135x7mm 15,5 Ø € 27,50
--	--	---	---	---	--	--	---

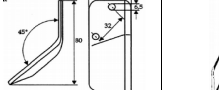
<b>Strautmann</b> Seko #100  10,5 Ø 4kt. 85x85x4mm € 4,50	<b>Strautmann</b> li./re. #233/34  210x80x5mm LA 108 € 22,90	<b>Seko #225/226</b> R/L geb. 50°  76x81x3mm LA 52 / 6,5 Ø € 3,95	<b>Sgariboldi #70-460 re.</b> <b>Sgariboldi #70-461 li.</b> Abb. rechts  210x95x5mm Standard € 17,90 beschichtet € 24,90	<b>Sgariboldi</b> gerade R/L  51x80x5mm LA 31 / 7 Ø € 6,90	<b>Sgariboldi</b> gebogen R/L 70-159/160  51x76x5mm LA 31 / 7 Ø € 7,30	<b>R.M.H.</b> 80 x 50 x 5 mm  Loch 8,5 Ø 70-182 gerade € 7,20 70-277 gebogen € 5,90	<b>R.M.H</b> 130 x 62 x 10 mm Abbildung rechts  553.042.100 links 553.042.000 rechts € 12,90
--	--	---	--	--	---	---	---

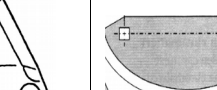
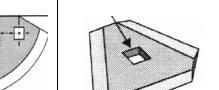
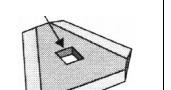
<b>Luclar/Sgariboldi</b> Unimix/Walker # 119  51x80mm gerade 6,5 Ø D 2001 / 2,5 mm € 1,95 D 2001 / 3,0 mm € 2,35	<b>Storti / Walker</b> L/R 70-293 / 70-294  Abbildung rechts 160x85x5mm LA 90 / 12 Ø € 14,90	<b>Walker/Strautmann</b> R/L # 123/124  <b>Sgariboldi</b> 90x40x4mm LA 32 / 6,5 Ø € 3,95	<b>Walker gerade</b> 16800029  68x51x4mm LA 31 / 8,5 Ø € 4,95	<b>Walker gebogen</b> 16800030  62x90x4mm LA 67 / 8,5 Ø € 7,95	<b>Walker #204</b> halbrund  280x107x6mm LA 190 € 19,50	<b>Zago 60613001</b> #187 dreikant  103x85x4mm Loch 10,5mm € 5,50
---	---	---	--	--	---	---

weitere Messer für Futtermischwagen auf Anfrage - [www.industriehof.com](http://www.industriehof.com)



# Mähdrescherteile

radura

## Mähmesser passend für:

Claas mit Kugelkopf			€
120 mm Abstand bis Mitte Kugel			
41 Klg.	für Einzelfinger	3,00 mtr.	219,00
<b>Claas Kugelkopf 70 mm Abstand bis Mitte Kugel</b>			
41 Klg.		610.644.1 3,00 mtr.	249,00
<b>Claas mit Flachkopf</b>			
40 ½ Klg.	1-teilig	3,00 mtr.	229,00
52 ½ Klg.	2-teilig	3,90 mtr.	299,00
56 ½ Klg.	2-teilig	4,20 mtr.	315,00
60 ½ Klg.	2-teilig	4,50 mtr.	329,00
68 ½ Klg.	2-teilig	5,10 mtr.	365,00
<b>Claas Lexion 1-teilig genietet mit Kopf</b>			
80 ½ Klg.	1-teilig	6,00 mtr.	434,00
88 ½ Klg.	1-teilig	6,60 mtr.	499,00
<b>Claas Lexion Sektional geschraubt mit Kopf</b>			
80 ½ Klg.		6,00 mtr.	539,00
88 ½ Klg.		6,60 mtr.	579,00
100 ½ Klg.	#51810	7,50 mtr.	599,00
140 ½ Klg.	#52402	10,50 mtr.	769,00
<b>Claas Schneidwerk Typ 528 geschraubt mit Kopf</b>			
90 ½ Klg.		6,80 mtr.	749,00
102 ½ Klg.		7,70 mtr.	799,00
<b>Case-Droningborg Sektionalmesser Bj. 1992-2002</b>			
81 Klg.	#51350	6,16 mtr.	539,00
89 Klg.	#51351	6,77 mtr.	569,00
101 Klg.	#51352	7,60 mtr.	629,00
<b>Fahr Typ 1124 Sektionalmesser</b>			
56 ½ Klg.	#16967	4,20 mtr.	335,00
64 ½ Klg.	#16968	4,80 mtr.	359,00
80 ½ Klg.	#16971	6,00 mtr.	425,00
<b>Fendt / MF mit Schumacherschneidwerk</b>			
81 Klg.	#17424	6,16 mtr.	509,00
89 ½ Klg.	#17425	6,77 mtr.	559,00
101 Klg.	#17426	7,60 mtr.	579,00
<b>New Holland Sektionalmesser geschraubt</b>			
60 ½ Klg.	ab Bj. 87 #51627	4,50 mtr.	445,00
68 ½ Klg.	#51628	5,10 mtr.	509,00
80 ½ Klg.	#51629	6,00 mtr.	525,00
96 ½ Klg.	#51713	7,20 mtr.	649,00
<b>John Deere Schneidwerk 600 / 800 oder 900</b>			
82 Klg.	800 Serie #16933	6,20 mtr.	559,00
87 Klg.	900 Serie #16872	6,80 mtr.	589,00
101 Klg.	900 Serie #16873	7,50 mtr.	629,00

## Schneidwerkteile passend für:



passend für Claas		€
Reibungsplatte	522.181.1	3,20
Messerhalter	626.749.1 DO + Lexion	4,90
Einzugsfinger	676.143.0 DO 12x210mm	5,00
Einzugsfinger	603.759.1 DO 16x205mm	6,50
Einzugsfinger	648.068.2 DO 16x245mm	7,20
Typ 528 / 529	358.344.1 Lex. 16x275mm	11,20
Haspelzinken	690.309.1 DO neue Ausf.	2,80
Haspelzinken	626.987.0 pass. Lexion	2,80
Tastbügel	519886.0	52,90
Tastbügel	7530290M	52,90
Gleitkufe	603902.0 490 mm breit	169,00
<b>passend für Deutz-Fahr</b>		€
Einzugsfinger Topliner	16054345	7,90
Haspelzinken Kunststoff	16000929M	3,40
Führungsplatte 256x5mm	10743.01	4,80
Rolle obenführend	16330 = 19035	17,90
Rolle untenführend	15768 = 19036	17,90



## Ährenheber pass f. Claas

Frank	€	ab 10 St.
CM 100	12,90	11,90
CM 300	13,90	12,90



Org. Schumacher		
	€	ab 10 St.
CM 300	17,90	16,90



## Ährenheber



	ASL
Original Schumacher	€ 20,90
Ährenheber Nachbau	€ 14,50
ab 10 Stück 5% Mengenrabatt	
Schumacher	ASL 100
Claas	ASL 120
New Holland / Biso	ASL 127
Deutz Fahr	ASL 100
Droningborg / MF	ASL 120
Fendt	ASL 100
Fiat-Laverda bis 1989	ASL 100
Fiat-Laverda ab 1990	ASL 127
IHC Finger 3.160592	ASL 121
John Deere	ASL 100
MF langer Finger	ASL 127
Sampo S1447501	€ 12,95

Halter für Ährenheber  
KM 3 € 3,20



## Doppelfinger



passend für:	€
Biso Rapsvorsatz 10SF02	11,90
Claas 676.235.3	11,95
Claas 626.295.1 Lexion verstärkt	13,90
Claas 0.519.600.0	12,20
J. Deere Z11228 mit Steg	10,50
J. Deere 3 - spitz H25603	27,90
J. Deere AXE 37174 mit Langloch	19,50
Fahr 0623 6756	18,50
IHC 3160592R2	34,50
IHC-Droningborg 44104500	10,90
Laverda 32111505 mit Steg	13,90
New Holland / Clayton 379720	10,90
Org. Schumacher Easy Cut	
16500.01 / 12mm Öffnung schwarz	16,90
16501.01 / 14mm Öffnung rotbraun	16,90
16503.01 / 3-fach Finger	39,50
10701.01 / Führungsfinger	36,90

## Mähmesserklingen



passend für:	€
Biso 301B03	1,20
Claas 611.203.1 oben. gezahnt	1,15
Claas 611.203.1 verzinkt	1,30
Claas 611.316 unten gezahnt	0,90
Clayton 365.110 oben gezahnt	1,10
Clayton 365.111 unten gezahnt	1,00
Droningborg 4410.3700 / 3mm	1,20
John Deere P 49650 ob. gezahnt	1,20
MF 206236 oben gezahnt	1,00
Mörtl Rapstrennmesser 106x58mm	5,40
New Holland 84429103 / 6mm Ø	1,20
New Holland 84429103 fein gez.	1,20
Schumacher Original Pro Cut fein	1,30
Schumacher Original Pro Cut grob	1,40
Klingenschraube 6x16 gez.	0,19

## Strohhäcksler-Messer

Erstausrüster-Qualität

lose glatt	lose gezahnt
3-seitig gezahnt	KPAB gewölbt
Lexion ohne Buchse	Lexion mit Buchse

Chromvanadium Schumacher / Radura

passend für:

Biso/Claas	3 mm lose glatt	€ 3,90
Biso	3 mm lose gezahnt	€ 4,60
Biso	4 mm lose glatt	€ 4,60
Biso	4 mm lose gezahnt	€ 4,95
Biso/J. Deere	4 mm 3-seitig gezahnt	€ 6,90

Case / MF-Droningborg/Record

4,5mm mit Buchse glatt	€ 7,95
4,5mm ohne Buchse glatt	€ 5,75
4,5mm ohne Buchse 3-seitig gezahnt	€ 7,60
4,5mm mit Buchse gezahnt	€ 8,90

Claas Lexion / Tucano 20 mm Loch

736.872.0 ohne Buchse glatt	€ 4,75
755.784.0 ohne Buchse gezahnt	€ 5,80
755.786.0 glatt beschichtet	€ 14,50

Claas Lexion 480/580 mit fester Buchse

755.874.0 2-seitig glatt	€ 6,90
755.787.1 3-seitig glatt	€ 7,40
755.875.0 3-seitig gezahnt	€ 6,90

John Deere

Z42175 3 mm lose glatt	19 Ø € 3,90
Z42176 5 mm lose glatt	19 Ø € 4,95

Z75875 4,5m lose gezahnt	20 Ø € 6,20
Z105500 5 mm lose gezahnt	20 Ø € 7,20

New Holland mit KPAB Häcksler

gewölbt 4 mm lose gezahnt	€ 7,90
gewölbt 5 mm lose gezahnt	€ 7,90
Loch 20 mm 5 mm lose gezahnt	€ 7,20

Gegenmesser passend für

Claas 3 mm fest glatt	€ 3,60
Claas 3 mm fest gezahnt	€ 4,50
John Deere 3 mm fest glatt	€ 3,60
Biso 3 mm fest glatt	€ 3,50
Biso 3 mm fest gezahnt	€ 4,40

Case/MF-Droningborg/Record

Case/MF 175 x 40 x 3 mm fest glatt	€ 3,90
Case/MF 3 mm fest gezahnt	€ 6,40

New Holland 3 mm fest glatt	
NH 555300-3 140 x 50 x 3 mm	€ 6,40
NH 10122 160 x 50 x 3 mm	€ 4,40

Biso - Buchse 3 mm	€ 2,95
Biso - Buchse 4 mm	€ 2,95
Biso - Scheibe 4 mm	€ 2,20
Claas-Buchse 3 mm außen	€ 2,95
Claas-Buchse 4 mm außen	€ 2,95
Claas-Buchse 3 u. 4 mm innen	€ 3,40
Claas Lexion Buchse 736.871.2	€ 3,20
Claas Lexion Scheibe 755.869.0	€ 3,20

Gegenmesser Claas Gegenmesser Biso

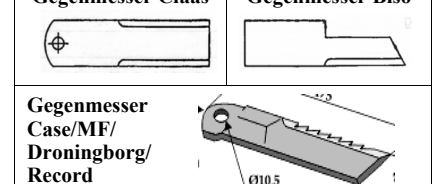

Gegenmesser  
Case/MF/  
Droningborg/  
Record

## Ketten für Mährescher Fabr. Tagex

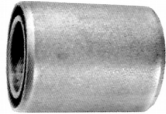

Kornelevatorkette passend für	€		Einzugs-kette passend für	€	
Claas Lexion 164 Gl. - 41 Pl.	735916.0	<b>549,00</b>	Claas Lexion 108 Gl. - 18WL	630567.2	<b>157,00</b>
Claas Dominator 38-58	654318.0	<b>329,00</b>	Claas Lexion 108 Gl. - 36WL	630643.2	<b>167,00</b>
Claas Dominator 86-98	607906.0	<b>389,00</b>	Claas DO 86-108 / 87 Gl.-15WL	680107.0	<b>115,00</b>
Claas Mega 208, 218	605456.2	<b>469,00</b>	Claas DO 106-118 / 94 Gl.-16WL	650843.2	<b>136,00</b>
Claas 114CS,115CS,228CS	642723.2	<b>599,00</b>	Claas DO 106-118 / 101 Gl.-17WL	610589.0	<b>146,00</b>
Claas Medion, Tucano139 Gl- 34 Pl.		<b>535,00</b>	Deutz-Fahr M3570/3640/ Starliner	16052140	<b>145,00</b>
Claas Kettenrad Bohr. 30 mm	674143.5	<b>39,50</b>	Deutz-Fahr Topliner 4060/4065/4070	16015522	<b>178,00</b>
Claas Kettenrad Bohr. 26 mm	678856.3	<b>39,50</b>	John-Deere 2054-/2266 / 111 Gl.	AZ46327	<b>178,00</b>
Deutz-Fahr Powerliner 4030	16011514	<b>415,00</b>	John-Deere 1169-1174 / 98 Gl.	AZ34242	<b>199,00</b>
Deutz-Fahr Topliner 4080/90	16006602	<b>685,00</b>	John-Deere 955-1075 / 87 Gl.	AZ24239	<b>122,00</b>
John-Deere 2264/2266 / 121 Gl.	AZ52338	<b>435,00</b>	New Holland TF 42 / TF 44 / TF 46	89837257	<b>169,00</b>
John-Deere 2054/2068 / 96 Gl.	AZ46273	<b>339,00</b>	New Holland TX 62 - TX 68	89814649	<b>179,00</b>
John-Deere 950-1085 / 169 Gl.	AZ29952	<b>490,00</b>	New-Holland CR960 Kettensatz 3 St.	86556409	<b>790,00</b>
New-Holland CX780-860 / CR	84145229	<b>499,00</b>			
New-Holland TX62-65 / TF76	84015232	<b>345,00</b>			
<b>Überkehrelevatorkette pass. für</b>			<b>Megu Lager</b>		
Claas Lexion 162 Gl. - 40 Platten	735367.0	<b>355,00</b>	passend für Claas		
Claas DO 76-118,114-228CS	678448.0	<b>285,00</b>	Dominator, Lexion, Medion		
John-Deere 2054-2068 / 162 Gl.	AZ46269	<b>449,00</b>	bitte Org. Nr. angeben		
John-Deere 975-1188 / 145 Gl.	AZ24219	<b>349,00</b>			

## Dreschkörbe und Schlagleisten für Mährescher

Dreschkorb passend für	Vergl.-Nr.	€	Schlagleisten passend für	Vergl.-Nr.	€
Claas Lexion 440-560 / 18 mm Durchgang	735550.2	<b>2599,00</b>	Claas Lexion 405/410/415/420/430/470	181742.0	<b>79,00</b>
Claas Lexion 440-560 / 10 mm Durchgang	759788.0	<b>2699,00</b>	Claas Lexion 440/450/460/480	177097.0	<b>89,00</b>
Claas DO 106/108 ohne Entgrannerklappen	682897.0	<b>2149,00</b>	Claas Lexion 510/520/530/570	174766.0	<b>105,00</b>
Claas DO 106/108 mit Entgrannerklappen	647483.0	<b>2249,00</b>	Claas Lexion 540/550/560/580/600	174764.0	<b>118,00</b>
Claas DO 86-98 ohne Entgrannerklappen	682892.1	<b>1949,00</b>	Claas Dominator 106-218 / Medion 340/360	177533.0	<b>85,00</b>
Claas DO 48-78 / 10 mm Durchgang	601720.0	<b>1949,00</b>	Claas Dominator 86-98 ab Bj. 80	177532.0	<b>74,00</b>
Deutz-Fahr Topliner 4070/4090/M5670/5690	06524042	<b>1859,00</b>	John Deere CTS9780/WTS9540/80	AZ58904	<b>77,00</b>
Deutz-Fahr Topliner 4060-4068	06549101	<b>1799,00</b>	John Deere 2054/2056/2258	AZ47216	<b>76,00</b>
Deutz-Fahr M1300-1630 / 3570-3640	06542049	<b>1969,00</b>	John Deere 630/950/965/1052/1157	AZ10690	<b>62,00</b>
John Deere 2064/2066/2264/2266	AZ49457	<b>3299,00</b>	John Deere 985/1085/1188	AZ26344	<b>82,00</b>
John Deere 2054/2056/2058/2254/2256/2258	AZ48843	<b>3199,00</b>	Deutz-Fahr M3480/3540/Powerliner	06543296	<b>62,00</b>
John Deere 985/1085/1188	AZ26186	<b>1949,00</b>	Deutz-Fahr M1300/3570/3580	16006802	<b>65,00</b>
John Deere 730/970/975/1075/1177	AZ17518	<b>1959,00</b>	Deutz-Fahr Topliner 4070/90 / M5670 / M5690	16006806	<b>78,00</b>
John Deere 530/630/950/1065/1167	AZ17516	<b>1759,00</b>	New Holland TF46/TF78/TX36/TX68	80398439	<b>95,00</b>
New Holland TF46/TF78/TX36/TX66/TX68	80913610	<b>1899,00</b>	New Holland TF42/44/72-76/TX32-65/CS520	80411996	<b>69,00</b>
New Holland CX820-880/CX8060-8090	47799886	<b>2249,00</b>	New Holland TX30/TC42/52/54	80411998	<b>72,00</b>

Schüttlerlager	Keilriemen Org. Tagex	Feuchtigkeitsmesser
passend für Claas	bitte Org. Nummer angeben	Unimeter Super Digital
passend für John Deere		
		<b>€ 349,00</b>
30 mm 618254.2 € 49,50	passend für Claas, John-Deere, Fendt	für Getreide, Weizen, Hafer, Gerste, Roggen
35 mm 678258.2 € 49,50	Deutz-Fahr, MF, New-Holland	Erbsen, Mais, Raps, Senf und Triticale
40 mm 678522.0 € 49,50		

## Verschleißteile für Feldhäcksler passend für Claas Jaguar - „Made in Germany“

Sägemesser p. f. Kemper / Orbis	Räumer	Häckslermesser	pass. f. Jaguar 820-900
 Messersatz kpl. mit Räumer + Schrauben		passend für Claas Jaguar 820-900	
<b>Messersatz</b>		390 x 90 mm	
<b>Standard</b>		€	€
Kemper C300 M3000	€ 460,00	62mm	Grasmesser 984.670.0/671.0
Kemper 330 M3004	€ 460,00	€ 659,00	= 989.101.1/102.1
Kemper 345	€ 680,00	€ 985,00	984.693.1 / 984.706.2 / 1324407
Kemper 360 M6008	€ 899,00	€ 1299,00	Maismesser 984.690.0/691.0
Kemper 375	€ 1130,00	€ 1590,00	59,90
Kemper 390 # LCA79039	€ 1690,00	€ 1950,00	80mm
Kemper 445 # 190190004	€ 799,00	€ 1099,00	Schleifstein 984.318.1
Kemper 460 Plus # 190190174		€ 1480,00	109,00
Kemper 475 Plus		€ 1780,00	Schleifstein 1.312.442.4
Orbis großer Rotor Premium	€ 99,00	€ 99,00	pass. für 930-980 Serie
Orbis kleiner Rotor Premium	€ 99,00	€ 99,00	Schraubensatz Gegenschneide
			31,50
			Gegenschneide Gras 495.273.2
			984.693.1 / 984.706.2 / 1324407
			649,00
			Gegenschneide Mais 495.274.2
			984.695.2 / 1318019.1
			765,00
			Gegenschneide Premium
			495.275.2 / 987.922.2
			1090,00
			Trommelboden 986.281.2
			569,00

# Siloentnahme / Zubehör für Dungstreuer und Ladewagen

**Silosäcke 190 gr/m<sup>2</sup> grün**  
mit Griff und Verschußdraht



Größe	ab 50 St.	ab 100 St.
100 x 25 cm	€ 1,25	€ 0,95
120 x 27 cm	€ 1,35	€ 1,05

Drillapparat für Verschußdraht € 13,50

**Silosäcke 190 gr/m<sup>2</sup> grün**  
mit Griff und Zugband



Größe	ab 50 St.	ab 100 St.
100 x 25 cm	€ 1,30	€ 1,05
120 x 27 cm	€ 1,40	€ 1,15

**Silo-Entnahmezinken**  
gekröpft



passend für:	Art.-Nr.	Länge / Kröpfung Gewinde	€
Alö	18834	820/60/M24	47,50
Alö	18921	920/60/M24	39,50
Baas	18817	815/60/M20	49,50
Bressel	18830	820/56/M22	51,50
Fella	18920	920/43/M27	72,00
Fella	18953	950/30/M22	59,00
Fella	18958	950/43/M22	56,50
Kverneland	18825	810/53/M20	49,50
Kuhn	18852	880/40/M22	49,00
Kuhn	181006	1000/40/M22	59,50
Lengerich	18911	920/43/M22	48,90
Stoll	18823	815/48/M20	51,50
Stoll	18837	820/- /M28	66,90
Stoll	18839	815/58/M24	62,50
Strautmann	18814	800/60/M20	39,50
Strautmann	M20	930/35 oder 60	56,00
Strautmann	M20	1000/35 oder 60	58,00
Strautmann	18843	840/45/M27	64,00
Trioliet	18851	880/50/M22	47,50
Vicon	18851	880/50/M22	47,50
Weidemann	18828	810/40/M22	49,50

**Siloschutzgitter 240 gr./m<sup>2</sup>**  
4 to Reißfestigkeit je m<sup>2</sup>



Größe	je Stück	ab 5 Stück
5 x 6 mtr.	€ 48,00	€ 45,00
5 x 7 mtr.	€ 55,00	€ 52,00
5 x 8 mtr.	€ 62,50	€ 59,50
5 x 9 mtr.	€ 71,00	€ 68,00
5 x 10 mtr.	€ 79,50	€ 74,50
5 x 12 mtr.	€ 95,00	€ 89,90
6 x 10 mtr.	€ 95,00	€ 89,90
10 x 12 mtr.	€ 189,00	€ 179,00

**Messer für Siloblocksneider**

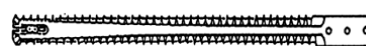

Doppelmesser passend für: €

Fella 860 mm 418946 1 Satz 475,00

**Reparaturband für Silagefolie**



75mm x 20 mtr.	schwarz	€ 11,90
100mm x 10 mtr.	schwarz	€ 4,50
100mm x 10 mtr.	grün	€ 4,50
100mm x 25 mtr.	weiß	€ 9,50

**Hochfeste Dungstreuerketten**

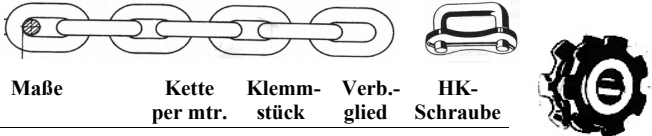

Maße	Kette per mtr.	Klemmstück	Verb.-glied	HK-Schraube
8x24	8,0 to 12,90	1,70	4,70	1,25
8x31	8,0 to 8,90	2,50	5,30	1,20
9x31	9,0 to 10,90	1,95	5,30	1,50
10x31	10,0 to 13,90	2,30	5,50	1,50
10x35	10,0 to 16,50	2,70	5,90	1,50
11x31	11,5 to 16,90	1,95	5,50	1,70
11x35	11,5 to 17,90	2,90	5,90	1,60
13x36	15,2 to 24,90		6,90	
14x50	19,0 to 29,50		24,90	

**Kratzbodenleisten - Streuflügel**

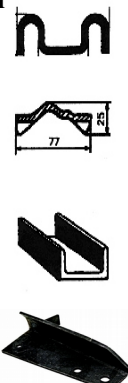

passend für	Länge	Bohrung	€
Bergmann M-Profil	1640 mm	10,5 Ø	34,50
Kemper Spez.-Profil gerade	1560 mm	10,5 Ø	42,50
Kemper U-Profil 25x50 M	1780 mm	13,0 Ø	42,50
Krone M-Profil gewölbt	1450 mm	10,5 Ø	33,50
Krone M-Profil gewölbt	1650 mm	10,5 Ø	37,50
Mengele U-Profil 40x20 P	1600 mm	10,5 Ø	34,90
Mengele U-Profil 25x50 F	1720 mm	10,5 Ø	42,50
Strautmann U-Profil 30x60 F	775 mm	12,0 Ø	38,00
Tebbe mit Rübüg Glied HF78	733 mm		46,50
Welger Spez.-Profil gew.	1580 mm	10,5 Ø	38,50
Welger Spez.-Profil gew.	820 mm	12,0 Ø	33,50

Streuflügel Bergmann 09570052/53 41,50

**Einfach - Rollenketten**



Tagex	Teilung mm	innere Breite	Rolle Ø mm	Preis per mtr.	Glied gerade	Glied gekröpft
1/2" x 3/16"	12,70	4,88	7,75	€ 9,80	€ 1,60	€ 4,40
1/2" x 1/4"	12,70	6,40	7,75	€ 10,00	€ 1,30	€ 2,30
1/2" x 5/16"	12,70	7,75	8,50	€ 10,30	€ 1,20	€ 1,70
5/8" x 3/8" 10B	15,88	9,65	10,15	€ 10,80	€ 1,30	€ 2,00
5/8" x 3/8" V	15,88	9,65	10,15	€ 13,80	€ 1,70	€ 3,20
3/4" x 7/16" 12B	19,05	11,70	12,07	€ 13,50	€ 1,40	€ 2,50
3/4" x 7/16" V	19,05	11,70	12,07	€ 22,50	€ 2,20	€ 3,50
3/4" x 1/2"	19,05	12,60	11,91	€ 14,40	€ 1,90	€ 3,10
3/4" x 1/2" V	19,05	12,60	11,91	€ 23,50	€ 2,20	€ 4,50
3/4" x 13,5mm	19,05	13,50	12,07	€ 27,90	€ 2,20	€ 3,30
1" x 1/2"	25,40	12,70	12,70	€ 63,50	€ 2,90	€ 5,20
1" x 1/2"	25,40	12,70	15,90	€ 56,90	€ 2,90	€ 5,30
1" x 5/8" ASA80	25,40	15,75	15,90	€ 49,50		
1" x 17mm/16B1	25,40	17,02	15,90	€ 25,50	€ 2,70	€ 3,90
1 1/4" x 3/4" 20B	31,75	19,60	19,05	€ 38,50	€ 4,00	€ 7,20
1 1/4" x 3/4" ASA100	31,75	18,90	19,05	€ 79,00	Laschen 4,9 mm	
1 1/2" x 1" 24B1	38,10	25,40	25,40	€ 68,00	€ 5,10	€ 9,80
1 1/2" x 1" ASA120	38,10	25,22	22,23	€ 136,90	Laschen 5,7 mm	



**Duplex - Rollenketten**

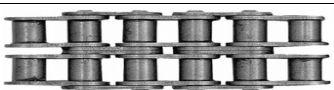

Teilung mm	innere Breite	Rolle Ø	Preis per mtr.	Glied gerade	Glied gekröpft	
3/4" x 1/2"	19,05	12,70	11,91	€ 35,50	€ 4,95	€ 5,40
1" x 17	25,40	17,02	15,90	€ 59,90	€ 5,90	€ 9,90

**Stahlgelenkkette Org. Kohlswa**

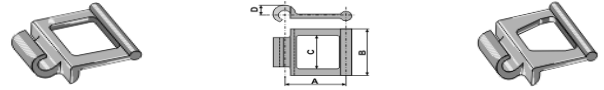

Art.Nr	Teilung A	Breite B	Bruchlast	Glieder p. mtr.	je Glied
69-074	60,6 mm	65,0 mm	65000 N	16,5	€ 6,80
69-078	67,1 mm	70,0 mm	50000 N	pass. f. JF / 14,9	€ 6,20
69-103	78,5 mm	87,0 mm	75000 N	12,7	€ 12,50

**Original Rübüg Gliederkette gesenkgeschmiedet**

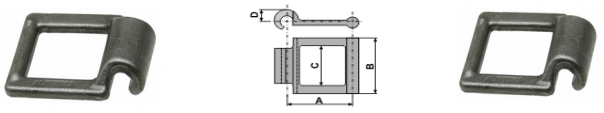

Art.Nr	Teilung A	Breite B	Bruchlast	Glieder p. mtr.	je Glied
HF 59	59,0 mm	49,0 mm	60000 N	16,9	€ 7,90
HF 67	67,0 mm	62,0 mm	80000 N	pass. f. JF / 14,9	€ 12,90
HF 78	78,5 mm	82,0 mm	125000 N	12,7	€ 19,80

# Zubehör für Frontlader / Anbaugeräte / Abdeckplanen

## Frontladerzinken

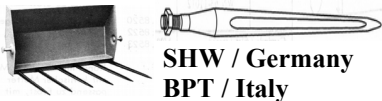

680 mm/M20 spitz BPT	€ 29,50
800 mm/M22 spitz BPT	€ 20,90
800 mm/M22 spitz SHW	€ 27,50
900 mm/M22 spitz SHW	€ 30,90
980 mm/M28 spitz SHW	€ 62,00
1000 mm/M22 spitz SHW	€ 34,90
1100 mm/M22 spitz BPT	€ 32,90
1100 mm/M22 spitz SHW	€ 39,50
1100 mm/M28 spitz BPT	€ 44,90
1100 mm/M28 spitz SHW	€ 55,90
1200 mm/M22 spitz SHW	€ 44,50
1250 mm/M28 spitz SHW	€ 63,50
1400 mm/M22 spitz SHW	€ 52,00
1400 mm/M28 spitz SHW	€ 99,00
<b>Stoll M20 SHW</b>	
800 mm Gewinde 35 lg. neu	€ 32,50
800 mm Gewinde 45 lg. alt	€ 32,50

## Schürfleisten für Schneeschilder



Gummi mit Gewebeeinlage	2000x150x20 mm	€ 110,00
Gummi mit Gewebeeinlage	3000x150x20 mm	€ 169,00
Polyurethan verst. Ausf.	2500x150x20 mm	€ 229,00
Polyurethan verst. Ausf.	3000x150x20 mm	€ 275,00



1. Vorschweißplatte gerade	€ 3,10
2. Vorschweißplatte gebogen	€ 3,70
3. Einschweißbüchse konisch	€ 2,90
4. Konushülse M22 / 100 mm	€ 4,50
5. Konushülse M22 / 120x44	€ 11,90
5. Konushülse M28 / 120x60 SHW	€ 18,95
5. Konushülse M28 / 145x57 BPT	€ 22,50

## Schürfschiene



Breite x Stärke	ST70-2	€
90 x 18 mm	Preis per mtr.	61,50

150 x 20 mm	Länge 2500 mm	€
<b>HB 400</b>		279,00

## Schürfschiene Hardox 500



Breite x Stärke	Länge	€
120 x 20 mm	1800 mm	259,00
120 x 20 mm	2000 mm	279,00
120 x 20 mm	2200 mm	319,00
120 x 20 mm	2400 mm	389,00
150 x 20 mm	2000 mm	369,00
180 x 20 mm	2000 mm	485,00
200 x 20 mm	2000 mm	569,00

## Kuppelplatten 1 Satz = 2 Stück



gebogen

500 x 180 x 10 mm  
€ 77,50

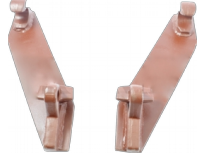

gerade Ausführung

€ 77,50



Haken lose

€ 7,90

## Schnellwechselrahmen



für Kat 2 (85 cm) und Kat 3 (100cm)  
€ 279,00

## Abschleppseil

Drahtseil verzinkt



mit 2 Ösen

6 mtr. / 20 mm € 59,90  
4 mtr. / 26 mm € 109,90

## Schlepper-Dreieck



Kat 2  
schwere Ausführung  
bis 1400 kg  
belastbar

€ 159,00

## Gerätedreieck



Gegenstück  
für  
Schlepper-  
Dreieck

€ 59,00

## Euronorm auf Dreipunkt



Adapter für Frontanbau € 359,00

## Dreipunkt auf Euronorm



Adapter für Heckanbau € 309,00

## Ballentransportgabel



Euronorm Schnellwechselrahmen

mit Zinken M22 / 1100 mm  
Zinkenabstand 750 mm € 285,00



mit Schwerlastzinken M28 / 1100 mm

und Dreipunktaufnahme € 399,00

für Dreipunkt  
und  
Anbaudreieck



aufklappbar

mit Zinken M22 / 1100 mm  
Abstand 700 mm € 299,00

## Siloballen-Transportgabel



Dreipunkt Kat 1 + Kat 2

manuell verstellbar  
€ 579,00

## Palettengabel



Zinkenlänge  
1200 mm

2000 kg

mit Euronorm Rahmen

Palettengabel kpl. € 795,00  
Grundrahmen lose € 495,00

## Abdeckplanen

PE-Gewebe sehr reißfest  
verst. Rand mit Ösen

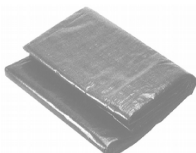

Ösenschutz (60 Stück)  
mit Zange € 7,50

	120gr/m <sup>2</sup>	210gr/m <sup>2</sup>
1,3 x 5 mtr.	€ 6,90	€ 11,20
1,5 x 6 mtr.		€ 11,20
1,3 x 10 mtr.	€ 14,20	
2 x 3 mtr.	€ 5,80	€ 7,90
3 x 4 mtr.	€ 9,50	€ 14,90
3 x 5 mtr.	€ 13,50	€ 17,90
3 x 6 mtr.	€ 20,50	€ 20,50
4 x 6 mtr.	€ 18,90	€ 28,90
5 x 6 mtr.	€ 38,90	€ 38,90
6 x 8 mtr.	€ 37,90	€ 56,50
8 x 10 mtr.	€ 62,90	€ 96,90
10 x 12 mtr.	€ 93,90	

## Haken



Planenhaken

Metall  
1,20

## Verschluss



Drehverschluss

€ 1,10

## Zurmulde



klappbar 800 DaN

100 x 95 mm  
€ 6,80

## Ringmutter



verzinkt

verzinkt  
M10 € 2,50 M16 € 4,95  
M12 € 3,20 M20 € 7,20

## Expanderseil



## Expanderset

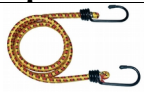

## Absperrband



rot-weiß

20 mtr.  
7mm € 8,90

2x60/2x 80cm € 3,50  
2x80/2x100cm € 3,95

50 mtr. € 5,90  
500 mtr. € 17,90



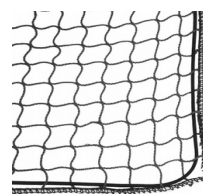

## Abdecknetz zur Ladungssicherung 3mm stark



70690	150x220 cm	€ 12,90
70691	150x270 cm	€ 13,50
70692	200x300 cm	€ 17,50
70693	200x350 cm	€ 24,90
37251	250x400 cm	€ 28,50
70696	300x500 cm	€ 45,90
37255	350x600 cm	€ 53,50
37256	350x800 cm	€ 69,90
Gummischlaufe f. dto.		€ 0,80



# Fahrzeugbau

Stützfuß Standard		Stützfuß mit Schnellverstellung		
1000 kg	4000 kg seitliche Kurbel	2500 kg	2500 kg	10000 kg
				
Hubhöhe 50 - 80 cm	Hubhöhe 62 - 93 cm	Höhe 65 - 120 cm Spindel-Hub 30 cm Auszug 25 cm Gesamthöhe 120 cm	Höhe 91 - 175 cm Spindel-Hub 49 cm Auszug 35 cm Gesamthöhe 175 cm	Höhe 90 - 162 cm Spindel-Hub 42 cm Auszug 30 cm Gesamthöhe 162 cm
Rohr 70 mm vierkant	Rohr 80 mm vierkant	Rohr 80 mm vierkant	Rohr 80 mm vierkant	Rohr 110 mm vierkant
	Zweigangetriebe	Eingangetriebe	Zweigangetriebe	Zweigangetriebe
€ 69,90	€ 129,00	€ 179,00	€ 219,00	€ 439,00

Hydraulischer Stützfuß				Stützrad		
einfachwirkend	doppelwirkend mit entsperbarem Sperrblock			1000 kg	1500 kg	2000 kg mit Übersetzung
						
Hubhöhe 45-70 cm	Hubhöhe 81-131 cm	Hubhöhe 82-132 cm	Hubhöhe 85-135 cm	Hubhöhe 80 - 110 cm	Hubhöhe 88 - 118 cm	
Rohr 100 mm schwenkbar 10000 kg Hubkraft	Rohr 90 mm	Rohr 100 mm	Rohr 110 mm	Rohr 70 mm	Rohr 90 mm	
	1950 kg Hubkraft	2800 kg Hubkraft	3800 kg Hubkraft	Rad klappbar	Rad klappbar	seitliche Kurbel
€ 329,00	€ 479,00	€ 499,00	€ 679,00	€ 119,00	€ 164,00	€ 329,00

### Bordwand-Verschluss



	Abbildung	€
1. Kippverschluss	links	32,90
2. Kippverschluss	rechts	32,90
3. Kippverschluss	gerade	32,90
4. Pendelbolzen		3,60
5. Kastenverschluss 135mm Gr.1	rechts	13,90
5. Kastenverschluss 170mm Gr.2	rechts	21,50
6. Halte - Ösen Gr. 1		5,90
6. Halte - Ösen Gr. 2		8,50
7. Winkelhebelverschluss 140mm	rechts	24,50
8. Eckverschluss	rechts	24,90
9. Haltenocken f. dto.	rechts	17,50
10. Exzenterverschluss		42,50
11. Haltenocken f. dto.		14,90



### Kornschieber



Größe	Ausführung	€
170x400mm	mit Blinddeckel	59,00
220x400mm	mit Blinddeckel	73,50
270x400mm	mit Blinddeckel	84,00
370x400mm	mit Blinddeckel	87,50
220x400mm	mit Auslaufrohr	145,00
370x400mm	m. Rohr 150 mm	149,00

### Stützräder für PKW - Anhänger



	€
200 kg / Rohr 50 mm	29,50
Halter für dto.	8,80
400 kg / Rohr 60 mm	89,00
Halter für dto.	17,50

### Duo-Matic Kupplungen

für Anhänger	für Schlepper
Gewinde 2 x M16	Gewinde 1 x M16 1 x M22
	
€ 42,90	€ 159,00

weiteres Druckluftzubehör siehe Seite 40

### Hemmschuhe verzinkt + Plastik













Länge	Breite	Höhe	€	Halter
300 mm	120 mm	160 mm	14,90	10,90
370 mm	160 mm	200 mm	26,90	13,90
435 mm	200 mm	245 mm	49,50	15,90
475 mm	200 mm	Plastik	17,50	
für PKW				
220 mm	90 mm	Plastik	4,80	2,20

Rungenhalter	Bordwandscharnier		Sicherungskettchen für Bordwand	Zugösen f. Anhänger		
	zum anschrauben	zum anschweißen				
verzinkte Ausführung	300 mm lg. € 24,50	270 mm lg. € 21,50		Stützlast	Zuglast	€
40 x 10 € 7,90	350 mm lg. € 34,50		Kette verzinkt 275 mm € 1,90	1000 kg	5000 kg	35,90
40 x 20 € 16,50	400 mm lg. € 34,50	420 mm lg. € 22,50	Sicherungsschnur Plastik € 1,20	1500 kg	10000 kg	49,50

Seilzugbremse für Einachser	Zuggabel-aufstieg	Klappauftritt mit Schlitz	Geschwindigkeitsbegrenzungsschild		Handbremshebel für Einachser 600 mm	
			zum kleben	zum nageln		
Hülle 2300 mm Seil 5150 mm € 179,00						
	verzinkte Ausführung	verzinkte Ausführung	6 km / 25 km / 40 km	25 km / 40 km	#350314	#350304
Einstecklasche lose € 16,90	€ 47,50	€ 14,90	50 km / 60 km / 80 km	€ 1,90	€ 63,00	€ 84,50

# Wasserinstallation und Zubehör



Verschraubung		Verschraubung		Rohrnippel verzinkt		Winkel verz.		Winkel verz.	
1/2" verzinkt € 3,95	3/4" verzinkt € 4,20	1/2" verzinkt € 4,60	3/4" verzinkt € 5,20	1/2" 40mm € 1,10	1/2" 60mm € 1,20	3/4" 40mm € 1,20	3/4" 60mm € 1,30	1/2" 45 Grad € 3,40	1/2" 90 Grad € 1,90
									
Dichtung 1/2" € 0,60	Dichtung 3/4" € 0,70	Dichtung 1/2" € 0,60	Dichtung 3/4" € 0,70	1/2" 100mm € 1,30	1/2" 150mm € 1,80	3/4" 100mm € 1,80	3/4" 150mm € 2,40	3/4" 45 Grad € 3,95	3/4" 90 Grad € 1,90
2 x Innengewinde		Außen- u. Innengewinde		1/2" 200mm € 2,50	2 x Außengewinde	3/4" 200mm € 2,80	2 x Außengewinde	2 x Innengewinde	Innen- und Außengewinde

Anschlüsse für IBC-Container		Muffe		Reduziermuffe		T-Stück		Hanfzopf	
	Wasserhahn 3/4" #221982 € 8,90	mit Panzerschlauch 70 cm Übergang 1/2" und 3/4" #221980 € 30,50	1/2" € 1,30	3/4" - 1/2" € 2,80		1/2" verzinkt € 1,80		200 gr. € 3,20	
			3/4" € 1,80	1" - 1/2" € 3,20		3/4" verzinkt € 2,50	3/4" - 1/2" € 2,50		<b>Neo-Fermit</b>
			2 x Innengewinde	2 x Innengewinde		3 x Innengewinde		150 gr. € 8,40	

Kugelhahn mit Schlauchtülle		Muffen-Kugelhahn		Kugelhahn		Doppelnippel		Stopfen		Kappe	
	1/2" € 7,90	3/4" € 11,50	1" € 12,90	2 x Innengewinde		Innen- und Außengewinde	1/2" € 1,20	1/2" € 1,10		1/2" € 1,40	
				1/2" € 5,90	3/4" € 7,90	1" € 11,90	3/4" € 1,60	3/4" € 1,20	3/4" € 1,70		

Schnellkupplung mit Schlauchanschluß		Gewindestück mit Innengewinde		Gewindestück mit Außengewinde		Dichtung		Blindkappe		Spritzdüse		
1/2" € 2,80	3/4" € 2,95	1" € 3,80	1 1/4" € 3,95	1 1/2" € 5,70	1/2" € 2,60	3/4" € 2,70	1" € 2,90	1 1/4" € 4,70	1 1/2" € 4,95	1/2" € 7,80	3/4" € 10,50	1" € 14,90
							€ 0,40		€ 2,80			

### Kupplungen Stecksystem

Stecker Messing		€
	1/2" Außengewinde	2,20
	3/4" Innengewinde	2,20
	3/4" Außengewinde	2,20
	1" Innengewinde	2,50
Kupplung Messing		€
	1/2" Schlauch	4,90
	3/4" Schlauch	4,90
Kupplung Messing mit Wasserstop		€
	1/2" Schlauch	6,90
	3/4" Schlauch	8,50
	<b>Spritzdüse verstellbar 1/2" € 4,50</b>	

### Schlauchschellen



	verzinkt	V2A
<b>9 mm breit</b>	€	€
8- 16 mm 3/8"	0,70	1,00
12- 20 mm 1/2"	0,70	1,00
16- 27 mm 3/4"	0,80	1,00
20- 32 mm 1"	0,80	1,10
<b>12 mm breit</b>	verzinkt	V2A
25- 40 mm 1 1/4"	1,20	1,30
32- 50 mm	1,20	1,40
40- 60 mm	1,40	1,80
50- 70 mm	1,60	1,80
60- 80 mm	1,60	1,80
70- 90 mm	1,80	1,90
80-100 mm	1,80	1,90
100-120 mm	2,00	2,10

### Wasserschlauch

Hochdruck-Qualitätsschlauch für Industrie, Gartenbau sehr flexibel kältefest- alterungs- u. witterungsbeständig

Größe	Rollenslänge	Betriebsdruck	p/mtr. €	b. Rolle €
-15° bis +60°				
1/2" PVC gelb	50 Meter	15 bar	1,90	1,80
3/4" PVC gelb	50 Meter	15 bar	3,20	2,95
1" PVC gelb	50 Meter	12 bar	5,60	5,10
-40° bis +95°				
1/2" EPDM	40 Meter	20 bar	4,70	4,30
3/4" EPDM	40 Meter	20 bar	6,80	6,20
1" EPDM	40 Meter	20 bar	10,90	9,90

### Kupplungen System Kamlock

aus Polypropylene	Vaterteil	€
	1 1/4" 32 mm	5,50
	1 1/2" 38 mm	5,50
	2" 51 mm	6,50
Mutterteil		€
	1 1/4" 32 mm	15,90
	1 1/2" 38 mm	17,50
	2" 51 mm	19,90

### Kaltreiniger

für starke, hartnäckige und ölige Verschmutzungen

5 ltr. Kanister € 25,90





### Waschgeräteschlauch pass. f. Kärcher

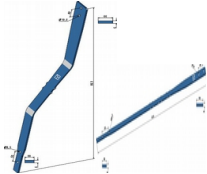

mit Gummiknickschutz

	2-seitig M22 Überwurfmutter	mit Nippel 11 mm	
Länge	210 bar	400 bar	210 bar
10 mtr.	€ 86,50	€ 95,00	€ 84,90
15 mtr.	€ 115,00	€ 139,00	€ 109,00
20 mtr.	€ 129,00	€ 175,00	€ 159,00
<b>Adapter mit Nippel 10 mm € 26,90</b>			

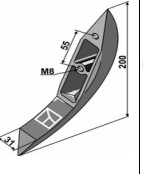
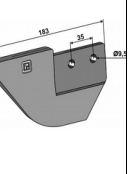
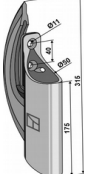
# Gülle-Zubehör

Gülle Flanschschieber Messing Fabr. MZ			passend für Bomech				pass. f. Flieg
Typ MZ	mit großem Oberteil						
2-seitig Flansch	verstopfungsfrei	Flansch + Gewinde	Blattfeder	Gummidüse	Schleppschuh	Schleppschuh	Schlitzschuhdüse
150 mm / 6" € 169,00	150 mm / 6" € 389,00	133 mm / 5" € 205,00	900 lg. gerade € 35,00	95155 € 7,20	95089 € 16,90	90-35001 € 22,90	GFZUSG900100 € 39,90
200 mm / 8" € 429,00		150 mm / 6" € 249,00	860 lg. gebogen € 49,50				

Hebelgarnitur für Flanschschieber			Stopfbuchsenmutter	Hydraulikzylinder f. Schieber	
Standard	schwere Ausführung	R / L	mit Schmiernippel	einfachwirkend	doppelwirkend
					
6" € 24,90	4" - 6" € 29,90	4" - 6" € 34,50	6" € 6,90	6" € 149,00	6" € 139,00
8" € 31,50	8" € 34,90	8" € 54,90	8" € 8,90	8" € 189,00	8" € 139,00

MZ Platten - Flanschschieber verstopfungsfrei mit Edelstahlplatte				Dreiwegehahn	Drehflansch
	mit Hydraulikzylinder doppelwirkend		mit Pneumatikzylinder doppelwirkend		
6" € 499,00	6" € 599,00	6" € 795,00	6" € 945,00	4" € 539,00	6" € 309,00
8" € 649,00	8" € 749,00	10" € 1199,00	10" € 1399,00	5" € 595,00	8" € 359,00

PVC-Rohr	Halter	T-Stück	Winkel 45°	Winkel 90°	Bundbuchse	Rundflansch
5 mtr. / 10 bar mit einer Klebemuffe	für PVC-Rohr	3 x Klebemuffe	2 x Klebemuffe	2 x Klebemuffe	für Rundflansch	verzinkt für Bundbuchse
						
160 mm € 175,00	160 mm € 17,50	160 mm € 56,00	160 mm € 35,90	160 mm € 49,50	160 mm € 29,50	160 mm € 39,90
200 mm € 259,00	200 mm € 21,90	200 mm € 125,90	200 mm € 63,90	200 mm € 69,00	200 mm € 42,90	200 mm € 45,90

### Kompressor für Güllewagen Battioni



Modell	Schlauchanschluß	€
MEC 6500	60 mm	1495,00
MEC 8000	60 mm	1595,00
MEC 8000	80 mm	1595,00
MEC 11000	80 mm	2095,00
MEC 13500	100 mm	2390,00

540 UPM

### Sicherheitsventil MZ mit Schlauchanschluß



1 1/4" Gewinde	€ 42,50
1 1/2" Gewinde	€ 45,90
2" Gewinde	€ 50,90

### Syphon-Abscheider mit Kunststoffgehäuse





60 Ø Schlauchanschluß	€ 139,50
80 Ø Schlauchanschluß	€ 178,00

### Ersatzglas für Abscheider

passend für MZ 60 Ø und 80 Ø € 21,90

### Schauglas mit Gewinde 2" € 2,90



Tangit-Reiniger für PVC	Tangit-Kleber für PVC
	
125 gr. € 16,50	250 gr. € 19,90
1000 gr. € 26,50	1000 gr. € 48,50

### Manometer



1/4" Gewinde Anschluß unten	
63 Ø Anzeige -1/+3,0 bar	€ 14,50
63 Ø Anzeige -1/+3,0 bar mit Glycerin gefüllt	€ 16,90
1/2" Gewinde Anschluß unten	
100 Ø Anzeige -1/+3,0 bar	€ 22,50

### Lamellen aus Hartgewebe

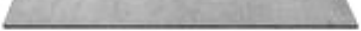

für Kompressor	Abmessung	€
MEC 4000	300x41,0x7 mm	12,50
MEC 5000	300x46,5x6 mm	12,90
MEC 6500	370x46,5x6 mm	13,90
MEC 8000	450x46,5x6 mm	16,50

### Vacupress Flex Schlauch für Schleppschlauch – Verteiler

mit verzinkter Stahlspirale – innen und außen glatt



	Druck	Biegeradius		€
100 mm x 8 mm	10 bar	300 mm	per mtr.	43,00
127 mm x 9 mm	7 bar	370 mm	per mtr.	69,50
152 mm x 9 mm	5 bar	480 mm	per mtr.	85,00
200 mm x 11 mm	3 bar	650 mm	per mtr.	179,00

# Gülle-Zubehör

## Spiralschlauch für Güllewagen



		PVC		Gummi
25 Ø	p/mtr.	€	3,40	
30 Ø	p/mtr.	€	4,40	
32 Ø	p/mtr.	€	3,90	
35 x 2,7	p/mtr.	€	4,80	
38 x 3,7	p/mtr.	€	6,50 (Schleppschauch)	
40 x 3,9	p/mtr.	€	6,90 (Schleppschauch)	
50 x 4,1	p/mtr.	€	10,50 (Schleppschauch)	
60 Ø	p/mtr.	€		27,50
70 Ø	p/mtr.	€		45,00
76 Ø	p/mtr.	€	18,90	37,90
80 Ø	p/mtr.	€		39,00
90 Ø	p/mtr.	€	27,00	
100 Ø	p/mtr.	€	29,00	48,00
110 Ø	p/mtr.	€	34,50	51,00
120 Ø	p/mtr.	€		58,00
125 Ø	p/mtr.	€	39,00	61,00
133 Ø	2 mtr.	€	92,00	134,00
133 Ø	3 mtr.	€	138,00	199,00
150 Ø	2 mtr.	€	91,00	154,00
150 Ø	3 mtr.	€	136,00	230,00
150 Ø	4 mtr.	€	182,00	306,00
160 Ø	2 mtr.	€	119,00	176,00
160 Ø	3 mtr.	€	178,50	264,00
200 Ø	2 mtr.	€	189,00	230,00
Alle Größen bis 20 mtr. ( 50 mtr.) lieferbar !				

## Schlauchklemmen

stabile Ausführung  
mit Gewindestange



verzinkt			
32- 35 mm		€	1,30
36- 39 mm		€	1,30
40- 43 mm		€	1,40
43- 47 mm		€	1,70
48- 51 mm		€	1,70
52- 55 mm		€	1,70
56- 59 mm		€	1,70
60- 63 mm		€	1,80
64- 67 mm		€	2,20
68- 73 mm	60 Ø / 22 br.	€	2,30
74- 79 mm	65 Ø / 24 br.	€	2,50
80- 85 mm	70 Ø / 24 br.	€	2,50
86- 91 mm	75 Ø / 24 br.	€	2,80
92- 97 mm	80 Ø / 24 br.	€	2,90
98-103 mm	85 Ø / 24 br.	€	3,00
104-112 mm	90 Ø / 24 br.	€	3,00
113-121 mm	100 Ø / 24 br.	€	3,30
122-130 mm	110 Ø / 24 br.	€	3,30
131-139 mm	120 Ø / 26 br.	€	4,20
140-148 mm	125 Ø / 26 br.	€	4,30
149-161 mm	133 Ø / 26 br.	€	4,90
162-174 mm	150 Ø / 26 br.	€	4,70
162-174 mm	aus V2A	€	10,90
175-187 mm	159 Ø / 26 br.	€	5,60
175-187 mm	aus V2A	€	13,50
201-213 mm	/ 26 br.	€	5,80
214-226 mm	200 Ø / 26 br.	€	6,00
214-226 mm	aus V2A	€	15,50

## Saugrohr für Güllewagen mit Schlauchtülle gerade



100 Ø	3 mtr.	€	85,00
125 Ø	3 mtr.	€	149,00
133 Ø	2 mtr.	€	99,00
133 Ø	3 mtr.	€	149,00
133 Ø	4 mtr.	€	179,00
150 Ø	2 mtr.	€	105,00
150 Ø	3 mtr.	€	139,00
150 Ø	4 mtr.	€	179,00
160 Ø	3 mtr.	€	169,00
160 Ø	4 mtr.	€	209,00

## Saugrohr für Güllewagen mit Schlauchtülle 45° Bogen



125 Ø	3 mtr.	€	135,00
133 Ø	3 mtr.	€	155,00
133 Ø	4 mtr.	€	185,00
150 Ø	3 mtr.	€	149,00
150 Ø	4 mtr.	€	175,00
150 Ø	5 mtr.	€	215,00
160 Ø	3 mtr.	€	195,00
160 Ø	4 mtr.	€	239,00

## Saugrohr System Perrot mit 45° Bogen und VT-Kupplung



150 Ø	4 mtr.	System Perrot	€ 369,00
150 Ø	5 mtr.	System Perrot	€ 429,00
200 Ø	4 mtr.	System Perrot	€ 395,00

## Bau- Industrieschlauch 10 bar



Synthetikschauch weiß komplett m. Kupplungen

"C"-Schlauch 52 mm			
10 mtr.	€ 52,50	20 mtr.	€ 89,50
"B"-Schlauch 76 mm			
10 mtr.	€ 94,00	20 mtr.	€ 139,00

## Saugrohr ital. System mit 45° Bogen und MT-Kupplung



150 Ø	4 mtr.	ital. System	€ 215,00
150 Ø	5 mtr.	ital. System	€ 259,00
200 Ø	4 mtr.	ital. System	€ 369,00
200 Ø	5 mtr.	ital. System	€ 399,00

## PVC-Flachschauch blau 8 bar mit Polyesterfaden Verstärkung

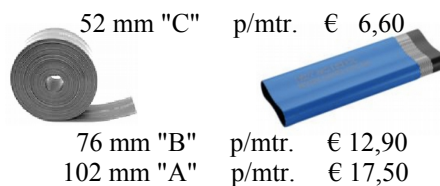

52 mm "C"	p/mtr.	€ 6,60
76 mm "B"	p/mtr.	€ 12,90
102 mm "A"	p/mtr.	€ 17,50

## Feuerwehrkupplung "Storz" Innen- oder Außengewinde

"C" 2"	Gewinde	€ 7,50
"C" 2 1/2"	Gewinde	€ 15,90
"B" 2 1/2"	Gewinde	€ 10,50
"B" 3"	Gewinde	€ 10,50
"A" 4"	Gewinde	€ 16,90



## mit Schlauchtülle

"C" 38mm Tülle	€ 7,50
"C" 52mm Tülle	€ 7,50
"B" 75mm Tülle	€ 10,80
"A" 100mm Tülle	€ 26,50



## Saugrohr ital. System mit 45° Bogen und VT-Kupplung



150 Ø	4 mtr.	ital. System	€ 209,00
150 Ø	5 mtr.	ital. System	€ 249,00
200 Ø	4 mtr.	ital. System	€ 345,00
200 Ø	5 mtr.	ital. System	€ 399,00

## Industrie-Beregnungsschlauch schwarz

Preis per mtr.



52 mm	76 mm	102 mm	125 mm
17 bar	15 bar	13 bar	10 bar
€ 11,50	€ 14,90	€ 23,50	€ 34,00

## Spaltenlanze 2mtr. lang

Rechteckrohr 80/20 mm mit Bogen 90°  
kpl. mit Feuerwehrkupplung "B"

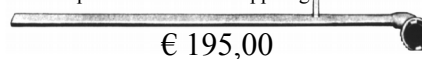

€ 195,00

## Strahlrohr kpl. mit Kupplung

"C"- Kupplung € 69,90  
"B"- Kupplung € 139,00



## Übergangsstück

Storz "B" - "C"	€ 18,50
Storz "A" - "B"	€ 30,50
Storz "C" - Geka	€ 9,50



## Blindkupplung

Storz "C"	€ 8,50
Storz "B"	€ 12,50
Storz "A"	€ 21,50



## Tankwagenkupplung

Messing 3 Zoll Innengewinde	
Kurvenstück VK 80	€ 39,90
Kronenstück TWK 80	€ 29,50
Spannring TWM 80	€ 44,90





## Kupplungen System Bauer









MT-Kupplung		VT-Kupplung	
100 mm	€ 20,90	100 mm	€ 47,90
133 mm	€ 33,90	133 mm	€ 72,50
150 mm	€ 37,90	150 mm	€ 83,50

# Gülle-Zubehör ital. System

Mutterteil italienisches System		
		
Öffnung A	Ø Schlauch	
Öffnung A	Schlauchanschluß Ø	€
132 mm	100 Ø	19,50
151 mm	125 Ø	24,50
151 mm	133 Ø	28,90
180 mm	150 Ø	29,90
180 mm	160 Ø	33,50
245 mm	200 Ø	83,90

Vaterteil italienisches System		
		
Öffnung A	Ø Schlauch	
Öffnung A	Schlauchanschluß Ø	€
100 mm	100 Ø	18,50
125 mm	125 Ø	25,50
125 mm	133 Ø	26,50
150 mm	150 Ø	31,50
150 mm	160 Ø	33,50
200 mm	200 Ø	76,90

Feuerwehr-Übergangsstücke mit 2 1/2 " Außengewinde und Storz 75 B Kupplung		
ital. System		
Größe	VT-Kupplung	MT-Kupplung
100 mm	€ 44,50	€ 44,50
133 mm	€ 46,90	€ 46,90
150 mm	€ 54,90	€ 54,90

Dichtungen		Flanschkupplung ital. System		Saugschlauch - Schnellkuppler	
ital. System	ital. System	Vaterteil	Mutterteil	ital. System	ital. System
					
100 mm / 4" € 1,20 133 mm / 5" € 2,20	150 mm / 6" € 2,80 200 mm / 8" € 5,40	100 mm / 4" € 37,90 133 mm / 5" € 42,90 150 mm / 6" € 52,50 200 mm / 8" € 112,00	100 mm / 4" € 44,50 133 mm / 5" € 48,50 150 mm / 6" € 55,50 200 mm / 8" € 137,00	mit Entlüftungsnippel Lochabstand 150 mm 150 mm 6" € 289,00	mit Entlüftungsnippel kurze Ausführung 150 mm 6" € 339,00



Bogen mit MT und VT Kupplung		Gewindekupplung ital. System		Perfekt-Verteiler ital. System	
ital. System	ital. System	Vaterteil	Mutterteil	VT-Kupplung	MT-Kupplung
					
Bogen 45 Grad verzinkt 150 mm / 6" € 82,50 200 mm / 8" € 185,00	Bogen 90 Grad verzinkt 150 mm / 6" € 84,50 200 mm / 8" € 189,00	mit Außengewinde 133 mm / 5" € 28,90 150 mm / 6" € 39,90	mit Außengewinde 133 mm / 5" € 31,50 150 mm / 6" € 39,50	150 mm / 6" € 159,00	150 mm / 6" € 179,00



Bogen ital. System		Blinddeckel ital. System		Umkehrstück ital. System	
mit Flansch + Vaterteil	mit Flansch + Mutterteil	Vaterteil	Mutterteil	2 x Vaterteil	2 x Mutterteil
					
133 mm / 5" € 72,00 150 mm / 6" € 105,00	133 mm / 5" € 75,00 150 mm / 6" € 105,00	150 mm / 6" € 24,50 200 mm / 8" € 59,90	150 mm / 6" € 26,50 200 mm / 8" € 72,50	150 mm / 6" € 59,90 200 mm / 8" € 142,00	150 mm / 6" € 60,50 200 mm / 8" € 149,00

Flanschplatte	Dichtung	Blindflansch	Blindflansch	Flanschtülle	Flansch mit
schwarz		schwarz	verzinkt	verzinkt	Außengewinde
					
150 mm 4"- 6" € 11,50 200 mm 8" € 17,50	150 mm 4"- 6" € 2,50 200 mm 8" € 3,40	150 mm 4"- 6" € 12,90 200 mm 8" € 18,50	150 mm 4"- 6" € 23,90 200 mm 8" € 38,90	100 mm 4" € 38,90 150 mm 6" € 39,90 159 mm 6" € 39,90 200 mm 8" € 67,50	150 mm 5" Gewinde € 51,50 150 mm 6" Gewinde € 57,50





Rohrbogen 2 x Flanschplatte			Handgriff	Rohrnippel schwarz		Kompresse
verzinkt 17 Grad für Schnellkuppler	verzinkt 45 Grad	verzinkt 90 Grad	für Gülleschlauch	zum anschweißen		220 Ø x 470 mm lang
						
150 mm / 6" € 37,50 200 mm / 8" € 49,90	150 mm / 6" € 99,00 200 mm / 8" € 179,00	150 mm / 6" € 99,00 200 mm / 8" € 179,00	150 mm 6" € 22,90 200 mm 8" € 23,90	2" € 14,50 2 1/2" € 16,20 3" € 17,50	4" € 21,50 5" € 21,50 6" € 23,90	aus Polyurethan € 695,00 aus Gummi € 419,00



# Gülle-Zubehör passend für Perrot



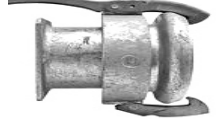

Mutterteil Original Perrot		
 		
Öffnung A	Ø Schlauch	
Öffnung A	Schlauchanschluß Ø	€
145 mm	100 Ø	39,50
145 mm	110 Ø	42,90
171 mm	125 Ø	56,90
171 mm	133 Ø	63,90
203 mm	150 Ø	59,90
203 mm	160 Ø	68,90
287 mm	200 Ø	199,00

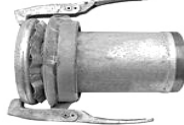

Vaterteil Original Perrot		
 		
Öffnung A	Ø Schlauch	
Öffnung A	Schlauchanschluß Ø	€
108 mm	100 Ø	16,50
108 mm	110 Ø	16,90
133 mm	125 Ø	20,90
133 mm	133 Ø	25,50
159 mm	150 Ø	23,50
159 mm	160 Ø	29,90
216 mm	200 Ø	89,00

Feuerwehr-Übergangsstücke mit 2 1/2 " Außengewinde und Storz 75 B Kupplung		
Perrot System		
	<b>Größe</b>	<b>VT-Kupplung</b>
108 mm	€ 37,50	€ 77,50
133 mm	€ 52,00	€ 119,00
150 mm	€ 53,90	€ 119,00

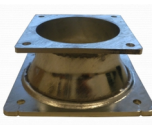
Dichtungen		Flanschkupplung Original Perrot			
System Perrot	System Perrot	Vaterteil	Vaterteil mit Abgang	Mutterteil kurze Ausf.	Mutterteil lange Ausf.
					
70 mm € 0,95 89 mm / 3" € 1,30	108 mm / 4" € 2,90 133 mm / 5" € 3,30 159 mm / 6" € 3,50 200 mm / 8" € 9,50	108 mm / 4" € 40,90 133 mm / 5" € 45,90 159 mm / 6" € 52,50 200 mm / 8" € 119,00	150 mm / 2" € 119,00 150 mm / 2 1/2" € 139,00 200 mm / 2" € 148,50 200 mm / 2 1/2" € 149,50	4" / 150mm lang € 73,90 5" / 150mm lang € 87,50 6" / 150mm lang € 92,50 8" / 200mm lang € 256,00	4" / 360mm lang € 74,90 5" / 360mm lang € 89,90 6" / 360mm lang € 114,90 8" / 400mm lang € 279,00

Bogen mit MT und VT Kupplung		Gewindekupplung Original Perrot		Saugschlauch - Schnellkuppler	
System Perrot	System Perrot	Vaterteil	Mutterteil	System Perrot	System Perrot
45 Grad Bogen	90 Grad Bogen				
159 mm / 6" € 145,00	108 mm / 4" € 75,00 159 mm / 6" € 129,00 200 mm / 8" € 409,00	108 mm / 4" € 26,50 133 mm / 5" € 40,90 159 mm / 6" € 45,50	108 mm / 4" € 56,50 133 mm / 5" € 83,90 159 mm / 6" € 96,50	Lochabstand 150 mm 150 mm 6" € 159,00	Lochabstand 180 mm 200 mm 8" € 295,00

Bogen System Perrot 90 Grad			Reduzierflansch	Umkehrstück System Perrot	
mit Flansch + Vaterteil	mit Flansch + Mutterteil	mit Tülle + Vaterteil	verzinkt	2 x Vaterteil	2 x Mutterteil
					
150 mm / 6" € 89,00 200 mm / 8" € 299,00	150 mm / 6" € 175,00 200 mm / 8" € 498,00	150 mm / 6" € 75,00	Flansch 8" - Flansch 6" € 79,00	150 mm / 6" € 48,50 200 mm / 8" € 139,00	150 mm / 6" € 169,00 200 mm / 8" € 335,00

Blindeckel System Perrot		T-Stück verzinkt		Zwischenstück verzinkt	
Vaterteil	Mutterteil	3 x Flansch	mit Reduzierung	150mm lang	300mm lang mit Abgang 2"
					
150 mm / 6" € 27,90 200 mm / 8" € 74,90	150 mm / 6" € 73,50 200 mm / 8" € 179,00	150 mm 4"-6" € 105,00 200 mm 8" € 159,00	2 x 8" + 1 x 6" Flansch € 149,00	150 mm 6" € 57,00 200 mm 8" € 115,00	150 mm 6" € 79,00 200 mm 8" € 142,00

Komprese			Flanschstutzen		Andocktrichter		Reduzierkupplung	
								
150 mm lang					<b>Aktion</b>		<b>Org. Zunhammer</b>	
Ø	Polyurethan	Gummi	für Andocktrichter 6" € 62,50		6" € 269,00	6" € 299,00	System Perrot 8" - 6"	
150	€ 139,00	€ 69,00	für Andocktrichter 8" € 75,00		8" € 299,00	8" € 329,00	VT-Kupplung 200 mm	
200	€ 199,00	€ 89,00	für Andocktrichter 10" € 239,00		10" € 499,00	10" € 499,00	MT-Kupplung 150 mm	
							€ 166,00	
							System Perrot 8" - 6"	
							VT-Kupplung 150 mm	
							€ 369,00	

Melkmaschinenreiniger QAV frei					Dipmittel / Reiniger Pulver			Kälbermilchwärmer				
									2300 Watt	2300 Watt	2300 Watt PTFE beschichtet	1700 Watt PTFE beschichtet
Adirox Chloro	alkalisch	flüssig	24 kg	43,90	<b>Dipmittel</b>							
Adirox Acid	sauer	flüssig	25 kg	43,90	IO-Spray Dip Jod 2700 ppm	21 kg	94,90					
Kersia TOP CL	alkalisch	flüssig	25 kg	57,90	<b>Melkmaschinenreiniger Pulver</b>							
Kersia TOP Acid	sauer	flüssig	25 kg	65,90								
RS Alcalin Melkroboter	alkalisch	flüssig	25 kg	64,90	Kersia mit Chlor alkalisch	25 kg	104,90	Easy-Heat	Standard	Super-Heat	Fast-Heat	
RS Acide Melkroboter	sauer	flüssig	25 kg	64,90	Kersia sauer	25 kg	94,90	€ 129,00	€ 205,00	€ 229,00	€ 235,00	

AgriMat	Euterwaschmittel	KerbaDip Jod	UdderoDip Jod	KerbaDip Lacto	UdderoDip Lacto
alkalischer Gerätereiner	KerbaWasch auf Jodbasis	sprühfähiges desinfizierendes Dipmittel auf Jodbasis	filmbildendes desinfizierendes Dipmittel auf Jodbasis	sprühfähiges Zitzendipmittel auf Basis von Milchsäure und Chlorhexidin	filmbildendes Zitzendipmittel auf Basis von Milchsäure und Chlorhexidin
Konzentrat	100 ml pro 10 Liter Gebrauchslösung	Zitzendipmittel mit Jod	Zitzendipmittel mit Jod	jodfreies Zitzendipmittel	jodfreies Zitzendipmittel
10 kg Kanister € 59,90	20 kg Kanister € 109,00	20 kg Kanister € 79,90	20 kg Kanister € 84,90	20 kg Kanister € 69,90	20 kg Kanister € 82,90

Melkmaschinenöl	Milchzelltest	Stalldesinfektion	Kersia	Milchtankbürste	Bürsten
für Alfa, Fullwood, Miele und Westfalia geeignet		wirkt gegen behüllte und unbehüllte Viren, Mykoplasmen, Bakterien (inkl. Salmonellen) und Pilze	Foam ND		
	1 ltr. Flasche € 6,20			Bürste ohne Stiel € 21,40	Kannenbürste € 11,40
5 ltr. Kanister € 20,90	5 ltr. Kanister € 29,90	1 ltr. Flasche Rhodasept € 13,95	Steril 10 kg € 51,90	Stiel f. dto. 100cm € 16,40	Stielbürste 29174 € 13,90
20 ltr. Kanister € 74,90	Schalmtestscheibe € 3,20	Konzentrat € 13,95			

Euterpapier	StimuCLEAN	UdderoCLEAN	Dipsprüher	Steildipper	Euterhandsprüher	Gleitschleim
1 Pack = 2 x 200 Blatt	besonders Saugstark				Org. Gilmour	
		Eutertücher waschbar	Modell Angular	mit Rückschlagventil	mit Messinginsatz	Vet Gel 1 kg
€ 5,90	2 x 780 Blatt € 18,90	34x37cm / 50 Tücher € 16,90	500 ml € 9,90	300 ml € 6,90	€ 9,95	€ 4,50
ab 5 Pack € 5,50						
ab 30 Pack € 5,20						

Kälbertränkeimer komplett mit Ventil und Sauger				Ersatz - Sauger		Kälberflasche	
Kunststoff	mit Hygieneventil	weiß, gelb, rot oder blau	Ersatzteile		mit Kreuzlochung	Speedy Feeder	
		mit Skala transparent			weiß 100 mm € 0,90	3 stufig	
			Halteblech € 1,25		rot 100 mm € 0,90		
			Ersatzventil € 1,80		rot 125 mm € 0,95		
			Dichtung rot € 0,30		Latex 100 mm € 0,90	Ersatzdeckel € 13,50	
mit Sauger rot € 7,95	m. Latex Sauger € 15,90	mit Sauger rot € 9,90	Dichtung blau € 0,30		Naturkautschuk € 1,00	Flasche 2,5 ltr. € 26,90	
	Ersatzventil € 6,50				Sauger mit Rundloch	Flasche 4 ltr € 32,90	
					weiß € 0,95		
					Naturkautschuk € 1,10		

Milchflasche	Speedy-Drencher	Calf Drencher	Calzogol Bolus	Eingeber für	Calz-O-Phos
	Org. Shoof 3-Wege Dosierhahn flexible Sonde 2,5 ltr. Inhalt	Profi	45 Gramm Kalzium und Vitamin D3	Bolus und Käfigmagnet	zur Versorgung von Kühen mit Kalzium und Phosphor
2 ltr. € 6,30	Flasche kpl. 1479 € 32,50	feste Sonde € 14,50	4 x 175 Gramm	#2129 53 cm € 25,90	500 ml € 5,95
3 ltr. € 12,90	Ersatzsonde 1483 € 19,90	flexible Sonde € 16,95	#15980 € 24,90	#2139 70 cm € 31,50	ab 12 Stück € 5,50
					ab 24 Stück € 4,95

Tonerde	Eutergel	Liniment	Kerba-Mint		Bufferlyt	Ket-o-Vital	Fertilgol
Spezial-Balsam	# 1521	Original NJP	Pfefferminzöl	Hängeflasche	Bolus für Kälber	Energie Bolus (Ketose)	Beta Carotin Bolus (Fruchtbarkeit)
			DLG Gütezeichen #15231 500 ml € 13,90	DLG Gütezeichen #15310 1000 ml € 29,90	#15984 bei Durchfall und Appetitmangel 15 x 13 Gramm € 19,90		
1 kg € 20,90	1 kg € 12,50	500 ml € 22,50	ab 5 Stück € 12,90	ab 5 Stück € 27,50		4 x 135 Gramm € 26,90	8 x 95 Gramm € 64,90

Kälberdecke	Agrobac-K	Agrolyt-K	Durchfallstopper	Desino Jod	KerbaWund	Zitzenkanülen
70 oder 80 cm			für Kälber Ferkel und Lämmer geeignet	zur Desinfektion von Haut und Nabel	Selbstheilungs Spray	
	Durchfallregulator	Durchfallregulator				
Standard #14156 € 19,90	1 kg € 21,90	1 kg € 15,90	Eutra Interlac-Pectin 2,5 kg € 28,90	500 ml #15894 € 19,50	500 ml #15239 € 19,90	10 Stück #1537 € 4,60
Premium #14158 € 32,90	5 kg € 84,90	5 kg € 51,50				

Zitzengummi passend für Alfa Laval					
927259-01	960008-80	960016-01	960017-02	960037-02	999009-01
Kopf 20 mm Ø	AK 2 / Kopf 27 mm Ø	AL 2 / Kopf 23 mm Ø	AL 4 / Kopf 23 mm Ø	AL 5 / Kopf 23 mm Ø	AL 7 / Kopf 20 mm Ø
Nachbau per St. € 5,60 für Roboter	Nachbau per St. € 5,10	Nachbau per St. € 5,90	Nachbau per St. € 5,90	Nachbau per St. € 5,90	Nachbau per St. € 5,90
		Original per St. € 14,95	Original per St. € 14,95	Original per St. € 14,95	Original per St. € 14,95

pass. f. Fullwood 020-215	pass. f. Miele 7720-0068-278	passend für Westfalia		Milchkannenspüle 100 ltr.	
7021-2725-220	7022-2725-150				
SLICTW	MK 3 / Kopf 25 mm Ø	#951 / Kopf 23 mm Ø	WK 2 / Kopf 25 mm Ø	Wandmodell mit Halter	€ 169,00
Nachbau per St. € 5,60	Nachbau per St. € 5,10	Nachbau per St. € 5,10	Nachbau per St. € 5,10	Tischmodell mit Gestell	€ 175,00
		Original per St. € 10,90	Original per St. € 10,90	Ersatzspüle lose	€ 124,00

Milchschläuche für Melkmaschine			Luftschläuche		Schaugläser	
Hauptmilchschlauch Gummi per mtr.	Doppel-Milchschlauch	Hauptluftschlauch	Doppelpulsschlauch	pass. für	pass. für	
13 mm € 6,40	15 mm € 7,20	für Bio-Melker per mtr.	10 mm / per mtr. € 4,50	Alfa € 0,70	Westfalia € 0,70	
14 mm € 6,40	16 mm € 7,50	10x5 mm € 9,90	12 mm / per mtr. € 5,20	Miele € 0,70		

Milchschlauch passend für Westfalia				Milchschlauch kurz		Milchschlauch		Pulsschlauch kurz			
7021-7101-000	140 mm	Loch 8 u. 10 mm	€ 4,50	€ 1,55	Nr.	Abmessung	für Alfa-Laval Roboter	Nr.	Abmessung		
7021-7101-010	180 mm	Loch 8 u. 10 mm	€ 4,50	€ 1,55	4642	150 mm verstärkt	€ 1,30	907.449.03	4660	180 x 7 mm	€ 0,70
7021-7101-020	140 mm	Loch 2 x 10 mm	€ 4,50	€ 1,55	4643	180 mm verstärkt	€ 1,30	doppelt 180 mm	4661	200 x 7 mm	€ 0,70
7021-7101-030	160 mm	Loch 2 x 10 mm	€ 4,50	€ 1,55				Nachbau € 7,50	4662	230 x 7 mm	€ 0,70

Pulsator	Adapter	Blindstopfen	Melkeimer	Melkeimerdeckel	Milchsammelstück
Taktung 60/40 			Kunststoff 30 ltr. 		
Modell L 80 € 134,90	für Alfa, Miele	für Melkzeug	mit doppelter Skala	flach mit 2 Nippel € 21,90	Chrom-nickelstahl 175 ccm geschraubte Ausführung
Modell L 90 € 139,90	Westfalia € 15,90	€ 1,80	€ 94,90	Dichtung für Deckel € 11,90	komplett € 87,00 Unterteil m. Dichtungen € 22,50

Überschuhe	Vormelkbecher	Wollzitzenstifte	Zitzenschutz	Eutra Melkfett	Euterholzwolle
			mit Nackengurt 		
100 St. Pack	mit schwarzem Teller	20 Stifte pro Dose		Zitzenpflege	zum einmaligen Gebrauch
50 cm hoch € 18,50	€ 4,90	1523 Standard € 3,95	1567 mittel € 41,90	1 kg Dose € 11,20	12 kg #15821
30 cm hoch € 15,90		1554 rote Perle € 4,20	1568 groß € 41,90	5 kg Eimer € 41,90	€ 42,50
knöchelhoch 40 St. € 5,90			1569 extra groß € 41,90		

Einmalhandschuhe - Melkhandschuhe				Ärmelschoner wasserdicht			
Latex gepudert	5,5 mil	8 mil	armlang/Polyethylen	#15385	Oxford #15387	Softshell mit Daumenschlaufe	
Gr. S,M,L,XL	Gr. S,M,L,XL,XXL	Gr. S,M,L,XL,XXL	50 St. € 14,50	mit Gummibund € 8,90	atmungsaktiv € 8,90	€ 10,90	
100 St. € 8,50	100 St. € 12,90	50 St. € 15,90	100 St. € 11,90				

Milchfilterschläuche Sana geschweißt / genäht						Reinigungsschwämme			
hochwertiger Vliesstoff Pack-Einheit je 250 Stück									
Nr.	Abmessung passend für	1 Pack	4 Pack	Nr.	Abmessung pass. f.	1 Pack	4 Pack	jede Größe zu 10 Stück verpackt	
46670	250 mm für Miele, Lister	15,50	55,80	46688	620 mm genähte Ausf.	29,90	108,00	Abmessung	€
46681	250 mm genähte Ausf.	16,90	59,60	46691	820 mm genähte Ausf.	45,90	165,00	Standard	40 x 80 mm 4,90
46683	320 mm genähte Ausf.	16,90	59,60					Standard	50 x 80 mm 4,90
46672	455 mm für Westfalia	22,50	81,00		für Roboter je 100 St.	1 Pack	4 Pack	Standard	60 x 80 mm 5,20
46684	455 mm genähte Ausf.	23,90	86,00	46783	570 x 44 mm	23,90	86,00	beschichtet	50 x 80 mm 7,20
46737	530 mm genähte Ausf.	32,90	118,00	46786	620 x 78 mm	30,90	111,00	beschichtet	60 x 80 mm 7,50

## Rinder-Anbindungen doppelt genäht

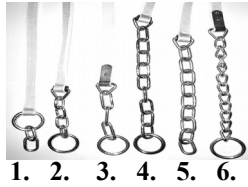

	Typ	Länge		Art.#	€	ab 10 St.
1.	Standard	1,80 mtr.	Ring am Gurt	1251	14,50	13,50
1.	Standard	1,90 mtr.	Ring am Gurt	1261	14,90	13,90
2.	Typ W	1,70 mtr.	Ring am Ende	12213	14,90	13,90
2.	Typ W	1,80 mtr.	Ring am Ende	1215	12,90	11,90
2.	Typ W	1,90 mtr.	Ring am Ende	1216	13,90	12,90
3.	W verstärkt	1,80 mtr.	Metallkauschen	1219	19,90	18,90
3.	W verstärkt	1,90 mtr.	Metallkauschen	1220	20,90	19,90
4.	Süd stall	1,90 mtr.	Ring am Ende	1218	15,90	14,90
5.	Bayern stall	1,93 mtr.	ohne Ring	1217	17,90	16,90
6.	Alfa neu	1,85 mtr.	gedrehte Kette	1244	25,90	24,90

## Aufhängeketten



ab 10 Stück  
8mm 180 cm € 15,50  
8mm 190 cm € 14,90 € 13,90

## Trevira-Anbindungen

mit 2 Barrenteilen Made in Germany  
mit 1 Barrenteil für Kälber



12461	85 x 4 cm	f. Kälber	€ 15,50
125303	100 x 4 cm	f. Kälber	€ 15,30
12504	130 x 4 cm	grün	€ 20,90
12502	Halsband f. dto. lose		€ 9,20
12520	150 x 5 cm	f. Jungbullen	€ 39,40
12521	Halsband f. dto. lose		€ 18,90
1228	165 x 7 cm	f. Bullen	€ 56,40
12501	Kuhhalfter		€ 15,50

## Halsbügel

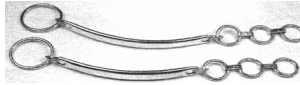

Rohr 25 cm, Gesamt 55 cm € 7,20  
Rohr 35 cm, Gesamt 78 cm € 8,20  
Rohr 45 cm, Gesamt 85 cm € 10,20

## Flachglieder-Halsbänder

8 Ringe 9x55 + 1 Ring 10x85 € 8,90  
4 Ringe 9x55 + Nylon € 20,40



## Kuhketten doppelt verlängert



	Standard	Flachglieder	Barrenteil	Knebel	Wirbel
4 mm	8,00		2,90		
5 mm	13,50		3,50	1,40	2,50
6 mm	15,90	19,90	4,10	1,70	2,90
7 mm	19,90	25,50	5,20	2,30	3,50
8 mm			6,80	2,60	4,90

## Barrenringe Holzschraube

M12 € 3,80



## Mutterschraube



## Steinkloben



## Meterkette

geraden C-Gliedern verzinkt  
(1 Bund 10 mtr.) Preis per mtr.  
3 Ø € 1,60 7 Ø € 4,60  
4 Ø € 1,70 8 Ø € 6,50  
5 Ø € 2,70 9 Ø € 6,90  
6 Ø € 3,30



## Akku-Schermaschine

Aesculap Bonum Pro

für Rinder und Pferde geeignet  
inkl. Akku  
und Schermesserset  
#GT644-NB



€ 429,00

## Viehtransportstricke



	€	ab 10 St.
blau-weiß 12mm/3,20 mtr	1,70	1,50
Kälberstricke 8 mm/1,80 mtr.	1,00	0,90
Bullenstricke 14 mm/3,50 mtr.	2,95	2,65

## Fesselband f. Pedometer



mit Ringverschluss  
40 cm lang € 3,50

## Halsmarkierungsband für Kühe

		Länge	Stück	ab 30 St.
20878	weiß Rollschnalle	135 cm	€ 4,50	€ 4,20
2088	weiß Ringverschluss	130 cm	€ 3,20	€ 2,90
20923	grün Plastikverschluss	130 cm	€ 5,40	€ 4,90
20887	für Kälber Rollschnalle	90 cm	€ 4,60	€ 4,20
20885	Nummernblock Standard 0-9		€ 0,40	€ 0,33
209420	Modell Duo 2-teilig aufklappbar 6er Pack		€ 11,60	



## Viehzeichenstift



blau,  
grün,  
schwarz,  
rot

je Stück € 1,60  
ab 10 Stück € 1,50

## Viehzeichenspray



400ml  
blau,  
grün,  
rot

400 ml je Stück € 4,90  
400 ml ab 5 Stück € 4,60

## Fußfessel



Nylon weiß € 6,95  
Nylon 1a grün € 12,50  
dto. verstellbar € 15,90

## Fußfessel



mit Polsterung € 21,50

## Schlagfessel

mit Kappe schwarz/grün



verzinkt € 7,50  
Edelstahl € 23,50

## Schlagfessel

mit Schnellverschluss



verzinkt € 18,50  
Edelstahl € 36,90

## Viehblende



€ 10,90



€ 12,90



€ 34,90

## Fesselbänder

aus Kunststoff 37 cm lang

gelb, orange,  
blau, rot  
und grün



je Stück € 1,90

ab 10 Stück € 1,80

## Fesselband

mit Klettverschluss

gelb, rot,  
blau und grün

oder Pack  
farblich  
sortiert



10 St. Pack € 6,50

## Schlagfessel

Org. Amerikanisch  
verstärkte Ausführung



€ 124,90

## Kuh-Hebegerät

bis 900 kg € 109,00

Profi-Ausführung



bis 1500 kg € 159,00

## Hebevorrichtung

für Kühe bis 1000 kg

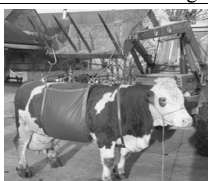

€ 269,00

## Kälberbox groß

200cm x 112cm x 143cm



#14604  
Gewicht 121 kg  
feuerverzinkt  
GFK Bodenrost  
Transport mit  
Palettengabel  
möglich

€ 839,00

## Kälberbox Premium

210 cm x 112 cm x 143 cm



mit schwenkbarem Boden  
Gewicht 143 kg  
feuerverzinkt  
GFK Bodenrost  
Transport mit  
Palettengabel  
möglich

€ 939,00

## Geburtshelfer

Modell HK 2020



€ 219,00

Paar Ersatzstricke € 4,90

Tränkebecken für Rinder und Pferde							Alubecken	
221500 V2A Zunge	€ 19,90	22202 Ersatzventil	€ 4,90	225030 Plastik	€ 28,50	221851	222020	für Wasserfaß
222000 Gußzunge Zunge absperribar	€ 29,90	22365 Bügel 2St.	€ 4,60	Bef.-Bügel	€ 11,20	mit Rohrnippel	große Schale 2 ltr.	€ 39,90
		22210 Halteplatte	€ 3,90			€ 39,50	€ 72,50	Ersatzventil € 9,40

Tränkebecken Original Allweiler				Tränkebecken Original Suevia					
Allweiler K2	€ 88,90	Ventil kpl.	€ 10,50	Allweiler L/5	Guß	Ideal Guß	Mod. 25R	1/2" oder 3/4"	Modell 1200 3/4"
Ersatz-Zunge K2	€ 28,20	Stößel Plastik	€ 2,20	#22466	Mod. 115	Mod. 61	Ersatzventil		Edelstahl / 5 ltr.
Ersatz-Zunge K1	€ 32,50	Stößel Messing	€ 2,40	€ 99,90	Ersatzventil	€ 15,90	€ 18,90	dto. Edelstahl	€ 20,50
									€ 94,00

Heizleitung 230 Volt			heizbare Tränkebecken Suevia und Zubehör								
	eingebautes Thermostat schaltet sich automatisch aus und ein geprüfte VDE-Sicherheit										
2 mtr.	€ 17,90	12 mtr.	€ 36,90	24 mtr.	€ 57,90	Suevia 41 A	Suevia 43 A	Suevia 46	Trafo für Becken	24V/100Watt € 66,90	Heizkabel 1,5m € 23,90
4 mtr.	€ 24,90	14 mtr.	€ 39,90	37 mtr.	€ 77,90	mit Zunge	Schwimmventil	mit Rohrventil	24V/200Watt € 75,50	Heizkabel 3,0m € 29,90	
8 mtr.	€ 29,90	18 mtr.	€ 48,50	49 mtr.	€ 99,50	€ 269,00	€ 284,00	€ 184,00	24V/300Watt € 99,90	Aluband 100m € 9,90	









Kunststoff - Tränkebecken heizbar 24 Volt oder 230 Volt					Schwimmertränke		Schwimmerventil		
Modell HP20 integriertes Frostschutzthermostat									
			Model SH30						
Tränkebecken	24V	230V	Tränkebecken	24V	230V	Guß klein 2 ltr.	€ 53,50	Standard #222905	€ 24,50
mit Rohrnippel			mit Schwimmerventil			Guß groß 3 ltr.	€ 94,90	Normaldruck Lacabac	€ 68,90
und Rohrbegleitheizung	134,90	134,90	und Rohrbegleitheizung	155,00	155,00	Plastik 5 ltr.	€ 53,90	Niederdruck Lacabac	€ 74,90









Futtertröge splitterfreier Kunststoff			Futterbox		Tränketrog		Suevia Tränketrog Edelstahl	
für Kälber und Schafe		für Kraftfutter		für Rinder und Pferde		für Kälberhütte		8 ltr. Kunststoff
Breite x Höhe x Tiefe		Breite x Höhe x Tiefe		Breite x Höhe x Tiefe		für Kälberhütte		mit Schwimmerventil
23 x 12 x 21 cm		33 x 33 x 28 cm		42 x 32 x 30 cm		30 x 48 x 25 cm		Br. 40cm x H. 49 cm
#3257 € 9,50		#32460 € 17,50		#3258 € 19,50		#144352 € 62,90		#22172 € 74,90
								€ 399,00
								€ 399,00









Lecksteinhalter		Lecksteine		Stalltafel		Heuraufe verzinkt		Schwimmerventil	
eckig Kunststoff		eckig verzinkt		mit Selen u. Zink		klein für Kälber		Suevia Masterflow 3/4"	
# 324793 € 2,90		20 x 20 x 23 cm		4 Stück je 3 kg		30 x 20 cm € 2,90		Modell 723 / 1 - 5 bar	
ab 10 Stück € 2,50		€ 10,20		€ 20,90		40 x 22 cm € 3,60		€ 49,90	
						40 x 30 cm € 3,90			
						€ 20,20			
						€ 50,90			

Futterschaufel		Käfigmagnet		Käfigmagnet		Stallriegel		Kipptränke Edelstahl inkl. Heizung	
2000 gr.		mit Innenstiel		je Stück € 1,75		forte #21150		mit Sicherung	
€ 2,90		€ 5,90		ab 30 Stück € 1,50		€ 4,90		#2984 € 5,90	
								€ 869,00	
								€ 949,00	



Revolver-Spritze		Kanülen Org. Henke		Dosierspritze		Eingabespritze		Drench-Matic	
Roux Original Henke		1 Packung = 10 Stück		Inhalt 20 ccm € 6,90				Org. HSW Premium	
Inhalt 30 ccm R2 € 48,90		1,0x15 mm € 9,20		Inhalt 30 ccm € 7,40		Drencher 300 ml € 32,90		kpl. mit Rückenkanister 2,5 ltr.	
Inhalt 50 ccm R4 € 49,90		1,2x20 mm € 9,20		Inhalt 50 ccm € 8,20		Drencher 500 ml € 60,90		€ 135,00	
		1,6x25 mm € 9,20							
		1,8x25 mm € 9,20							
		2,0x25 mm € 9,20							

Viehsaugentwöhner Modell Müller			Müller 2010 mit Überwurfschutz			Müller Suck-Stop	
klein weiß 	mittel gelb 	groß beige 	klein rot 	mittel orange 	groß blau 	für Kälber extra klein blau 	klein/mittel/groß transparent gelb oder weiß 
je Stück € 3,50 ab 12 St. € 3,20	je Stück € 3,50 ab 12 St. € 3,20	je Stück € 3,50 ab 12 St. € 3,20	je Stück € 3,90 ab 12 St. € 3,50	je Stück € 3,90 ab 12 St. € 3,50	je Stück € 3,90 ab 12 St. € 3,50	je Stück € 6,50 ab 6 St. € 5,95	je Stück € 6,50 ab 6 St. € 5,95

Viehsaugentwöhner Modell Legard				Bullen-Nasenringe			
							
klein #1322	mittel #1321	groß #1320	#1323 Zange	vernickelt 54mm	Drehbulli 59 mm	Drehbulli 59 mm	Saugstop
Stück € 1,50 ab 10 St. € 1,40	Stück € 1,60 ab 10 St. € 1,50	Stück € 1,80 ab 10 St. € 1,70	€ 19,50	€ 4,30	vernickelt € 4,60 ab 18 St. € 4,10	Edelstahl € 5,95 ab 18 St. € 5,40	€ 9,90 ab 10 St. € 9,40





Klauen Schleifscheiben							
Widia 1-seitig	Widia 2-seitig	3 cut	6 cut	P 6	Super Profi	Standard	Klauen spray
							
115 Ø € 21,50 125 Ø € 25,50 178 Ø € 75,90	115 Ø € 30,90 125 Ø € 39,90	120 Ø # 16316 € 119,00 Messersatz € 39,90	120 Ø # 16318 € 129,00 Messersatz € 79,80	mit 6 Messer 105 Ø € 78,90 125 Ø € 91,90	90 Ø / #16309 mit 4 Messer € 124,00	ab 5 St. 115 Ø € 3,20 125 Ø € 3,50 178 Ø € 4,40	grün #2779 mit Teebaumöl 400 ml Spraydose € 14,90







Hufmesser Profi		Klauen schneider		Teerverband	VetTape weiß	Blauspray	
doppelt	rechts / links	Super Profi	#165	25 mtr. x 5 cm	50 mtr. x 50 mm	BlauDes	Agro Chemica
	#16801 #16803 #16805		#16814 #16815				
		Seitenschneider 60 cm lang	Standard 41 cm lang	je Stück € 10,50 ab 10 Stück € 9,50 ab 50 Stück € 8,90	#16388	500 ml € 8,50	200 ml € 7,90





Rollwatte	Polster-Binde	Verbandvlies	Hufteer	Puderspray	Silberspray	Zinkoxidspray
Rollino	Cottino Star	Absorba		Agro Chemica		
#16464 10 cm x 3 mtr. 8 Stück Pack. € 13,50	#16478 10 cm x 3 mtr. 6 Stück Pack. € 13,50	#16453 5 mtr. x 10 cm € 8,20	1 kg € 5,50 5 kg € 18,50	200 ml € 8,50 400 ml € 12,50	Agro Chemica 200 ml € 9,40	Agro Chemica 200 ml € 7,90

Klauenbandage 4,5 mtr.	Klauenbinde	Kurzzug-Mullbinde	Fixierbinde	Zitzenverband
VETlastic rot blau grün oder schwarz	VETlastic rot blau grün oder schwarz			
7,5 cm breit € 1,60 ab 24 Stück € 1,40	10 cm breit € 1,95 ab 18 Stück € 1,80	unelastische Spezialbinde #16451 8 cm x 6 mtr 10 Stück Packung € 12,90	100% Baumwolle #16449 10 cm x 4 mtr. 20 Stück Packung € 9,90	elastisch 4 mtr. lang #16461 8 cm 20 Stück € 7,90 #16463 10 cm 20 Stück € 9,30



Bandagenmesser	Klauenwanne	Durchlaufmatte	Klauenbad	Fußmatte	Demo-Tec
					
80 cm lang € 29,90 Ersatzmesser 10 St. € 7,80	203cm x 83cm x 18,5cm #16603 € 279,00	180cm x 90cm #16416 € 155,00	ClawPlus Konzentrat 25 ltr. Kanister € 199,00	zur Desinfektion 55cm x 45cm € 37,50 85cm x 60cm € 52,90	Easy Bloc 12 er Pack mit Plastikschuhen € 114,00

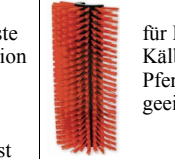

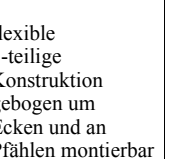



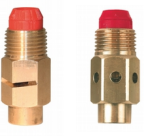

Technovit Standard 6091	Technovit mit Beschleuniger	Holzklötze für Technovit			Technovit-2-Bond Zweikomponenten-Klauenkleber	Technobase 2CB
		#16104 112 mm lang	XL #16105 130 mm lang	schräg #16132 112 mm lang		
10 er Pack € 85,90	10 er Pack € 89,90	Standard je Stück € 0,90 ab 20 St. € 0,80 ab 50 St. € 0,70	extra groß je Stück € 1,20 ab 20 St. € 1,10 ab 50 St. € 1,00	Keilform je Stück € 1,20 ab 20 St. € 1,10 ab 50 St. € 1,00	Starterset für 10 Anwendungen kpl. mit Pistole #16239 € 75,90 ohne Pistole #16240 € 49,90 Ersatzkartusche #16241 € 25,90 Mischkanülen #16243 € 7,90	#16282 #16295 Kartusche Kanüle 210 ml 12er Pack € 25,90 € 13,90







Enthornungsgeräte				Viehreiber		
LötKolben Edelstahl # 17450  220 Volt / 210 W € 78,90	mit Trafo #17460  24 V / 250 Watt € 184,00	Akku - Buddex  neue Ausführung € 179,00	Gas - Buddex mit 2 Kartuschen  GasBuddex € 155,00 Kartusche € 6,20	Org. KAWE grau ohne Abschaltautomatik  kpl. mit Batterien € 68,90	Org. KAWE grau/rot  Modell 21 € 89,00	Ani Shock mit Lanze 71 cm  PRO 1500 € 69,90 PRO 2000 € 77,50





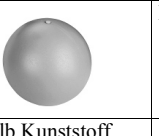

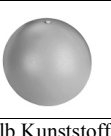
Viehbürste Lotte	Kratzbürste	Bürste Bully	Bürste Benny	Bürste flexibel	Futterspielball
 stabiler Metallrahmen Bürsten auswechselbar Ersatzfeder € 22,50	 halbrund Borsten aus Polyamid	 sehr robuste Konstruktion ausgelegt für die Bullenmast	 für Rinder, Kälber und Pferde geeignet	 flexible 3-teilige Konstruktion gebogen um Ecken und an Pfählen montierbar	 40 cm Durchmesser
Bürste komplett € 125,90 Ersatzbürste € 15,50	50 x 22 cm € 43,90 50 x 32 cm € 59,90	90 x 30 cm € 179,00 Ersatzbürste € 36,90	44 x 19 cm #293110 € 25,90	43 x 30 cm #293111 € 32,90	HeuBoy blau € 44,90



PVC - Streifenvorhang 3 mm		Big-Bag Auslauf		Kratzblech verzinkt		Kratzmatte	
	Hakenleiste Edelstahl 			 ausgelegt für die Bullenmast			
25 mtr. x 30 cm € 109,00 50 mtr. x 30 cm € 215,00 Pendelblech 30 cm € 3,20	100 cm € 16,50 150 cm € 25,90 200 cm € 34,90	#29428 € 119,00 mit Handschieber	#29389 € 99,00 Mod. Raimo	Kratzblech 90cm x 43cm € 58,90 Montageset Aufstallung 2" € 19,90 Montageset Aufstallung 2 1/2" € 20,90	aus Gummi für Kälber 40 x 30 cm € 22,50 60 x 40 cm € 36,50		

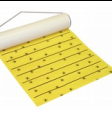

Infrarot Wärmestrahler Alu		Infrarotbirnen			Infrarot Sparlampen			Trogprüher	
									
ohne Sparschalter 2,5 mtr. Kabel € 14,50 5,0 mtr. Kabel € 15,90 großes Aluminiumgehäuse mit Schutzgitter mit Aufhängekette und Gummikabel 220 Volt	mit Sparschalter 2,5 mtr. Kabel € 17,50 5,0 mtr. Kabel € 18,90	150 Watt Aktion € 4,50 250 Watt Aktion € 4,50 150 Watt Philips € 7,90 250 Watt Philips € 7,90	je Stück € 4,50 ab 10 Stück € 3,95	100 Watt Aktion € 6,90 175 Watt Aktion € 6,90 100 Watt Philips € 11,70 175 Watt Philips € 11,70	je Stück € 6,90 ab 10 Stück € 6,50	1/2" Messing 3 Loch € 3,40 geschlitz € 3,20 1/2" Edelstahl geschlitz € 2,90			





Beißnippel Edelstahl		AquaGlobe		Mod. Lubing		Treibbrett		Treibpaddel		Eberspray	
											
3 stufig regulierbar Stift 8 mm 1/2" 72 mm € 3,20 1/2" 79 mm € 3,40 3/4" 82 mm € 3,40	3 stufig regulierbar Stift 12 mm 1/2" 61 mm € 3,40 1/2" 76 mm € 4,10 3/4" 77 mm € 4,10	Edelstahl Gewinde Messing 1/2" 79 mm € 14,60 3/4" 97 mm € 20,90	Druck regulierbar 1/2" 25x62 mm € 32,50 3/4" 28x80 mm € 39,50	Kunststoff 94x76 cm € 37,20 126x76 cm € 45,50	107 cm lang #22146 rot € 11,50	Boar Mate 80 ml € 7,90 250 ml € 17,50					





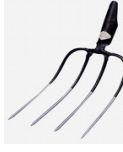

Maus- und Rattenfalle		Kastenfalle		Köderstation		Anti-Streßball		Beißkugel	
	mit ungiftigem Dauerköder Rattenfall Ersatzköder 3 Stück € 9,90 € 9,90	 Alive Predator Super	 Block-Box	 transparenter Deckel			 Naturkautschuk		
Mausefallen - Set 2 Stück € 5,10 Ersatzköder 6 Stück € 5,10	105 x 26 x 30 cm € 115,00 118 x 33 x 42 cm € 135,00	32x25x16cm 1 Stück € 9,90 ab 5 Stück € 8,50	23x18x10cm mit Schlagfalle € 11,50	gelb Kunststoff 30 cm Ø € 17,50	7,5 cm € 6,40 ab 25 St. € 5,80				







Fliegeneimer		Fliegenrolle Jumbo		Fliegenrolle mit erhöhter Fangleistung		Fliegenrolle gelb - Standard		Fliegenrolle weiß - eco		Fliegenrolle Twister	
	FlyCage 6 mit Deckel und Gittereinsätzen										
Eimer mit Lockstoff € 41,90 Lockstoff 750 gr. € 18,90	#299789 € 17,90 ab 5 Rollen € 16,90	#299847 € 14,50 ab 5 Rollen € 13,50	7 mtr. / 30 cm breit € 9,50 ab 5 Rollen € 8,50	10 mtr. / 25 cm breit € 8,50 ab 5 Rollen € 7,50	Twister 4 Stück € 1,90						







Fliegenfänger		Fliegenfänger Halley LED		EcoKill LED		Fliegenbogen	
	Fly-Master		mit Spritzwasserschutz IPX4				
kpl. mit 400 mtr. Band € 49,90 Ersatzrolle f. dto. € 26,50	LED 30 grün 50 x 34 cm 2x9W € 149,00 LED 40 grün 66 x 52 cm 2x12W € 215,00 Ersatzröhre LED 30 / LED 40 € 12,20 / 13,90	2x7 Watt 150qm 480x70x260 mm € 45,90 2 x 7 Watt blaue Röhren € 8,90 Ersatzröhre 7 Watt blau € 17,90	595 x 300 mm € 12,90 1 Pack = 6 Bögen gelb #299842				

Dunggabel Freund-Victoria mit Stiel					Streugabel Freund-Victoria mit Stiel						
											
Dunggabel silber	mit Stiel	Zinken	Länge	Breite	€	Streugabel gold	mit Stiel	Zinken	Länge	Breite	€
Dunggabel gold	mit Stiel	4 Zinken	31 cm	23 cm	27,90	Streugabel gold	mit Stiel	3 Zinken	25 cm	20 cm	32,50
Dunggabel anthrazit 1a	mit Stiel	4 Zinken	31 cm	23 cm	30,90	Streugabel gold	mit Stiel	3 Zinken	28 cm	25 cm	32,50
Dunggabel gold breit	mit Stiel	4 Zinken	31 cm	23 cm	37,90	Streugabel gold	mit Stiel	3 Zinken	30 cm	30 cm	32,50
Dunggabel gold breit	mit Stiel	4 Zinken	34 cm	28 cm	51,50	Streugabel anthrazit 1a	mit Stiel	3 Zinken	30 cm	30 cm	37,90
Dunggabel anthrazit 1a	mit Stiel	5 Zinken	31 cm	24 cm	47,90	Heugabel anthrazit 1a	mit Stiel	3 Zinken	37 cm	32 cm	48,50
Heugabel anthrazit 1a	mit Stiel	4 Zinken	37 cm	32 cm	63,90						

Streugabel			Heugabel			Dunggabel			Heugabel			Silogabel			Maisgabel		
3 Zinken ohne Stiel			3 Zinken ohne Stiel			4 Zinken ohne Stiel			4 Zinken ohne Stiel			6 Zinken ohne Stiel			6 Zinken ohne Stiel		
																	
Länge	Breite	€	Länge	Breite	€	Länge	Breite	€	Länge	Breite	€	Länge	Breite	€	Länge	Breite	€
26 cm	20 cm	26,50	37 cm	32 cm	36,50	31 cm	23 cm	19,90	37 cm	32 cm	47,90	35 cm	30 cm	34,50	36 cm	34 cm	41,50
30 cm	30 cm	16,90				33 cm	25 cm	35,50				43 cm	39 cm	71,50	gerade Außenzinken		

Kartoffelgabel			Pferdedunggabel Plastik			Dunghacke			Dunghacke			Gummi-schwapper								
mit Knopfspitzen			Drahtgabel			Org. Aubiose m. Aluminiumstiel			Kastengabel grün			3 Zinken			4 Zinken			Gummi-schwapper		
																				
Länge	Breite	€	Länge	Breite	€	kpl. mit Stiel	36,90	kpl. mit Holzstiel	14,90	Länge	Breite	€	Länge	Breite	€	Länge	Breite	€		
36 cm	27 cm	64,90	37 cm	32 cm	58,90	Ersatzgabel	26,90	40 x 30 cm		21 cm	17 cm	21,90	21 cm	20 cm	25,90	45 cm	60 cm	13,90		
										19 cm	16 cm	31,50	60 cm		16,90					

Güleschieber			Güleschieber			Kotkrücke		Stoßscharre		Wasserschieber			
gerade			gebogen			35 cm breit		Federstahl 1mm		Standard		Premium geschraubter Gummi	
													
gerade	€	Gummi	gebogen	€	Gummi	Stahlblech	€		€		€		€
30 cm	9,20	3,40	50 cm Stahlblech	17,50	4,90	8,90		30 cm	5,95	45 cm	7,80	40 cm	13,50
35 cm	10,20	3,80	66 cm Stahlblech	19,20	5,90			Ersatzblatt	4,20	55 cm	8,90	50 cm	14,80
40 cm	10,50	4,10	66 cm verzinkt	23,20	7,50	geschmiedet	21,50	50 cm	8,90	75 cm	11,70	60 cm	16,60
55 cm	12,90	4,60	73 cm verzinkt	26,90	7,90	Kunststoff	4,50	Ersatzblatt	5,20			80 cm	22,90

Pflanzspaten		Alu-Schaufel mit Stahlkante		Schaufel		Randschaufel		Sandschaufel					
Fabrikat Freund		Gr. 7 / 32 cm breit		Gr. 9 / 36 cm breit		Kunststoff		Stahlblech Org. SHW		Frankfurter-Schaufel		Holsteiner-Schaufel	
													
	€		€	Kerbl 29666	€	Breite x Länge	€		€		€		
Standard	10,90	Standard	10,90	40 cm breit		32 x 34 cm	30,90	Standard	5,90	Standard	5,90		
verstärkt	12,90	verstärkt	12,90	mit Stahlkante	10,20	38 x 34 cm	33,50	Idealspaten 1a	12,90	Idealspaten 1a	12,90		
58 x 13 cm	€ 43,50	Ersatzkante	2,30	Ersatzkante	2,30								

Spaten		Spatengabel		Ampferstecher		Spatenschaufel		Kreuzhacke		Wiedehopf-		Reuthacke	
Standart		Org. Freund		#29099		Fabrikat SHW		2,5kg		hacke mit Stiel		mit Stiel	
													
Kerbl	€ 56,90	27 x 18 cm	€	mit T-Stiel		Kohlenstoffstahl mit Tritt			€		€	Blattgröße	€
Fabr. Freund	€ 54,90	lackierter	44,50	Stahl geschmiedet	€ 56,50		€ 59,90	kpl. mit Stiel	27,50	Ovalblatt	57,90	22 x 12 cm	48,90
Idealspaten	€ 69,90	Eschenstiel						ohne Stiel	21,50	Breitblatt	57,90	Stiel lose	17,90

Großraumbesen mit verstärktem Stielhalter								Straßenbesen mit Bohrung					
rote Elastonborsten		rot-schwarze Borsten		Roßhaarborsten		mit Schabekante		rote Elastonborsten					
		<b>Argena-Elastonborsten</b> 											
40 cm	€ 8,90			50 cm	€ 12,90								
50 cm	€ 9,40	80 cm	€ 16,50	60 cm	€ 14,90	40 cm	€ 12,90	Elastonborsten		32 cm	€ 5,90		€
60 cm	€ 10,40	100 cm	€ 23,90	80 cm	€ 19,90	50 cm	€ 15,90	40 cm	€ 13,50	40 cm	€ 7,20	42cm dichte Borsten	7,90
				100 cm	€ 23,90	60 cm	€ 18,50	60 cm	€ 15,90	50 cm	€ 9,30	60 cm	11,90

Wasserbesen		Ersatzbesen		Baueimer		Stalleimer stabil		Edelstahleimer			
komplett mit Stiel		für Wasserbesen		Kunststoff schwarz		Kunststoff / Blecheimer		hochglanzpoliert			
Messing-Absperrhahn	€ 4,90		€		€	Kunststoff extrastark	€ 5,90	5,7 ltr. ohne Skala	€ 10,20		
35 cm weiß Perlonborsten	€ 28,50	Ersatzbesen weiß	10,40	12 ltr. Standard	1,70	Blecheimer 14 ltr.	€ 23,90	8,5 ltr. ohne Skala	€ 13,50		
super lange u. kurze Borsten	€ 34,90	Ersatzbesen super	19,60	20 ltr. mit Kreuzboden	2,95	Eimerhalter verzinkt	€ 9,90	12 ltr. mit Skala	€ 20,20		

Rübenhacke		Spargelhacke		Getreide-		Reisstrohbesen		Kehrschaufel		Handfeger		Drahtbesen	
dänische Form		geschmiedet		Schaufel		5 Nähte		Blech		mit Kokosborsten		mit Holzrücken	
18 cm breit	11,50	Breite x Höhe	€	33 cm breit	€		€		€		€		€
kpl. mit Stiel	24,50	20 x 6 cm	27,90	ohne Stiel	15,50	kpl mit Stiel	7,50	mit Holzgriff	4,90	mit Holzgriff	3,70	Stahldraht	9,50
Ersatzklinge	4,70	18 x 6 cm	26,90	mit Stiel	36,50							30 cm	

Heurechen und Straßenrechen								Laubbesen					
Kunststoff		mit Grasfangzinken		Eisenrechen 16 Zinken ohne Stiel		Teerrechen ohne Stiel		Holzrechen mit Stiel		verzinkt mit Stiel		Kunststoff mit Alustiel	
	€		€	geschmiedet	€	geschmiedet	€		€		€	Fabr. Freund	€
16 Zinken	14,90	16 Zinken	15,90	40 cm breit	14,90	16 Zinken	32,50	15 Zinken	13,90	22 Zinken	20,90	22 Zinken 55cm	21,90
64 cm breit		64 cm breit		52 cm breit	29,90	40 cm breit				verstellbar		30 Zinken 78cm	33,90

Geräte - Stiele					
	Axtstiel 700 lang	€ 6,50		Dunggabelstiel stumpf	€ 7,90
	Axtstiel 800 lang	€ 6,90		Dunggabelstiel mit Loch	€ 7,20
	Besenstiel 1300/24	€ 4,20		Dunggabelstiel m. Zwinge	€ 12,40
	Besenstiel 1500/28	€ 4,95		Schaufelstiel / Esche	€ 5,95
	Besenstiel 1800/28	€ 5,80		Schaufelstiel ab 5 Stück	€ 5,60
	Feldhauenstiel 42/28	€ 16,50		Kotkrückenstiel 1500/36	€ 8,40
	Feldhauenstiel 52/28	€ 17,90		Kotkrückenstiel 1800/36	€ 9,90
				Güleschieberstiel	€ 9,40
				Pickelstiel 950 mm	€ 7,20
				Spatenstiel mit T-Griff	€ 7,40
				Spatenstiel Esche 1a	€ 16,80
				Stoßscharrenstiel	€ 5,20
				Vorschlaghammerstiel	€ 5,70
				Wiedehopfhackenstiel	€ 15,90

Sichel		Sensensichel		Sense		Stiele f. Sense		Astschere Org. Freund		
				handgeschmiedet 3 x gedengelt ölgehärtet						
gewalzt	€ 16,90	geschmiedet		65 cm lang	€ 36,50	Metall	€ 18,90	Mod. 12 A1		Mod. 135 TA
geschmiedet	€ 29,20		€ 15,20	Wetzstein	€ 3,20	Holz	€ 18,50	€ 89,00	€ 76,90	€ 49,90

Schneeschieber		Schneeschieber Org. Freund Victoria				Alu-Schneeschieber Org. Mefro				
		Org. Freund		mit Alu-Stiel		Kunststoff mit kleinen Rollen				
Kunststoff mit Alukante		Holz mit Kante		Alu mit Stahlkante		82 cm breit		mit Holzstiel		mit Holzstiel
€ 19,90		€ 32,90		€ 46,50		€ 43,90		47 cm breit		58 cm breit
								€ 48,00		€ 58,00
										62 cm breit mit Räder
										€ 109,00

## Isolatoren für Litze, Band und Elektroseil

Schlitzisolator	Ringisolator	Ringisolator	Ringisolator	Bandisolator	Kombi-Isolator	Wickel-Isolator	Euro-Tape	Klippisolator
#44300	# 44326	Aktion	# 44324	# 44309	# 441380	# 441381	# 44380	# 441390
(je St. € 0,21)	(je St. € 0,27)	(je St. € 0,17)	mit Gewinde (je St. € 0,40)	(je St. € 0,35)	(je St. € 0,31)	(je St. € 0,23)	(je St. € 0,31)	Band und Seil
25 Stück Pack.	25 Stück Pack.	25 Stück Pack.	25 Stück Pack.	25 Stück Pack.	25 Stück Pack.	25 Stück Pack.	25 Stück Pack.	25 Stück Pack.
€ 5,25	€ 6,75	€ 4,25	€ 10,00	€ 8,75	€ 7,75	€ 5,75	€ 7,75	€ 7,75

Bandisolator	Klemmisolator	Klemmisolator	Eckisolator	Eckisolator	Klippisolator	Bandverbinder	Litzclip	Silververbinder
# 44340	# 44350	# 44359	# 44330	# 44348	# 441391		Edelstahl #442001/051	
(je St. € 0,40)		(je St. € 0,86)	(je St. € 0,76)		(je St. € 0,28)	verzinkt/Edelstahl	Band bis 20 mm	
10 Stück Pack.	je Stück	10 Stück Pack.	25 Stück Pack.	je Stück	25 Stück Pack.	20mm € 0,50/0,70	5 Stück Pack	6 mm € 0,70
€ 4,00	€ 1,65	€ 8,60	€ 19,00	€ 2,50	€ 7,00	40mm € 0,60/0,85	€ 8,50	8 mm € 1,40

Torgriffset	Torgriff	Isolator	Ersatzfeder	Torgriff	Euro-Haspel	Haspel Super
kpl. mit Feder und 2 Isolatoren	lose	für Torgriff	für Torgriff	mit Elastikseil	mit Feststellbremse	bis 1000 mtr. Litze
bis 5 mtr. # 44945 € 6,90	Standard € 1,50 Edelstahl € 4,60	Holzgewinde € 0,80 mtr. Gewinde € 1,00	# 44246 € 4,40	bis 6 mtr. € 16,40 bis 9 mtr. € 18,90	bis 200 mtr. Band € 11,50 bis 400 mtr. Band € 19,70	44270 kpl. € 16,20 Ersatzhaspel € 8,95



Drahtlitze	Weidezaundraht	Eisendraht	Stahldraht	Drahtspanner	Weidezaunlitze
verzinkt	Aluminium	verzinkt	Zink-Alu Legierung	drehbar	Org. Steuer
200 mtr. / 1,5 mm # 44500 € 8,50	400 mtr. 1,6 mm € 29,90 400 mtr. 2,0 mm € 39,90	250 mtr. / 1,8 mm # 44504 € 13,90	625 mtr. / 2,5 mm € 74,90	# 44513 € 2,85	2 x 0,5mm verz. Eisendrahte 1000 mtr. € 40,90

Basic preiswerte Lösung für kleinere Zäune stabile Edelstahlleiter 3 Jahre Garantie UV-Beständigkeit	Artikel Nr.	€	Band-Breite	Band-Länge	Leiter in mm	max. Zaunlänge	Widerstand	Farbe		
	Breitband	441520	<b>10,20</b>	10 mm	200 m	4x0,16	200 m	11,0 Ohm		weiß
	Breitband	441521	<b>12,20</b>	20 mm	200 m	4x0,16	200 m	11,0 Ohm		weiß
	Breitband	441522	<b>19,20</b>	40 mm	200 m	8x0,16	400 m	5,50 Ohm		weiß
	Litze	44521	<b>12,40</b>		250 m	3x0,20	1,0 km	7,74 Ohm		orange
	Litze	44833	<b>41,50</b>		1000 m	3x0,20	1,0 km	7,74 Ohm		orange
	Litze	441596	<b>13,40</b>		500 m	3x0,16	500 m	15,0 Ohm		orange
	Elektroseil	441508	<b>24,20</b>	6 mm	200 m	2x0,50	Kreuzw.	3,50 Ohm		weiß

TopLine Plus für mittlere und lange Zäune verst. TriCOND Leiter 4 Jahre Garantie UV-Beständigkeit	Artikel Nr.	€	Band-Breite	Band-Länge	Leiter in mm	max. Zaunlänge	Widerstand	Farbe			
	Breitband	4491504	<b>16,90</b>	10 mm	200 m	4x0,30	4 km	0,46 Ohm		weiß/rot	
	Breitband	449551	<b>22,20</b>	20 mm	200 m	5x0,30	5 km	0,37 Ohm		weiß/rot	
	Elektroseil	449532	<b>41,40</b>	6 mm	200 m	6x0,30	6 km	0,31 Ohm		weiß/rot	
	Litze	449119	<b>17,20</b>		300 m	3x0,30	3 km	0,63 Ohm		weiß/rot	
	Litze	449523	<b>47,90</b>		400 m	9x0,25	7,5 km	0,26 Ohm		weiß/rot	
	3 Jahre Garantie:										
	Steuer Litze	445035	<b>40,90</b>		1000 m	2x0,50	6 km	0,35 Ohm		transparent	







Star / Premium 40 mal höhere Leitfähigkeit verzinnzte Kupferleiter höchste Bruchlast 3 Jahre Garantie UV-Beständigkeit	Artikel Nr.	€	Band-Breite	Band-Länge	Leiter in mm	max. Zaunlänge	Widerstand	Farbe		
	Breitband	441501	<b>21,70</b>	12 mm	200 m	4x0,30	5 km	0,21 Ohm		weiß/grün
	Breitband	441502	<b>30,90</b>	20 mm	200 m	6x0,30	10 km	0,10 Ohm		weiß/grün
	Breitband	441503	<b>51,90</b>	40 mm	200 m	10x0,30	18 km	0,05 Ohm		weiß/grün
	Litze	44528	<b>35,20</b>		400 m	6x0,20	10 km	0,10 Ohm		weiß/grün
	WildHog	449312	<b>53,90</b>	Wildabwehr	400 m	6x0,25	30 km	0,06 Ohm		blau
	Elektroseil	44537	<b>78,50</b>	6 mm	500 m	6x0,30	14 km	0,07 Ohm		weiß/grün
	Elektroseil	44538	<b>36,50</b>	6 mm	200 m	6x0,30	14 km	0,07 Ohm		weiß/grün
Elektroseil	449540	<b>109,90</b>	6 mm	400 m	9x0,30	10 km	0,20 Ohm	weiß/rot		





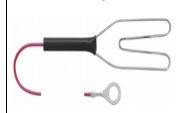
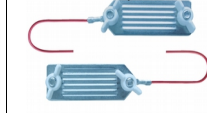

	AKO Akkugerät 12 Volt mit Zaunkabel					Kombigerät 12V + 230V Duo Power AKO		
	5 Jahre Garantie	A 2000	AN 4000	AN 6000		X 2500	X 4000	XI 8000
	Spannung bei 500 Ohm	7200 V	8400 V	9000 V		6400 V	8400 V	8700 V
	Ladeenergie in Joule - Out	2,50	4,00	5,00		2,50	4,0	8,0
	Zaun mittlerer Bewuchs	5 km	9 km	11 km		4 km	9 km	17 km
	€ 139,00	€ 184,00	€ 259,00	€ 149,00	€ 194,00	€ 309,00		

	AKO mit Solarpanel und Akku					Starterset AN6000	
	Sun Power	S 1500	S 3000	S 3800		Ako 441136	Ako 441137
	Spannung 500	4800 V	7600 V	8300 V		9000 V	9000 V
	Ladeenergie - Out	1,5 Joule	3,0 Joule	3,8 Joule		5,0 Joule	5,0 Joule
	Zaunlänge	3,0 km	6,0 km	8,0 km		11 km	11 km
max. Schafnetze	6 Stück	12 Stück	14 Stück	20 Stück	20 Stück		
Solarpanel	15 Watt	30 Watt	40 Watt	ohne	mit 45 Watt		
Akku 12 Volt	18 AH	18 AH	18 AH	Solarmodul	Solarmodul		
	€ 414,00	€ 499,00	€ 569,00	€ 469,00	€ 644,00		

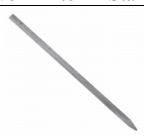
	AKO Netzgerät 230 Volt						Kombigerät 12V + 230V	
	5 Jahre Garantie	N 1200	N 3500	N 4800	Ni 6500	Ni 10500	NDi 12000	Ako Power Station Smart
	Spannung bei 500 Ohm	3400 V	5700 V	5700 V	8800 V	8800 V	8800 V	XDi 10000 digital
	Ladeenergie Joule - Out	1,20	3,50	4,80	6,50	10,50	12,0	XDi 15000 digital
	max. Schafnetze	5 Stück	14 Stück	18 Stück	20 Stück	35 Stück	38 Stück	8700 V
Zaun mittlerer Bewuchs	2 km	6 km	8 km	10 km	18 km	20 km	10,0	15,0
	€ 89,00	€ 145,00	€ 189,00	€ 289,00	€ 349,00	€ 699,00	35 Stück	40 Stück
							18 km	22 km
							€ 759,00	€ 859,00









weitere Weidezaungeräte und ausführliche Beschreibung unter [www.kerbl.de](http://www.kerbl.de)

Zaunanschlusskabel			Bandkupplung	Warnschild	Trockenbatterie	
rote Klemme Kabel 1 mtr.	grüne Klemme Kabel 1 mtr.	mit Herzklemme Kabel 1,25 mtr.	für Bänder bis 40 mm Kabel 0,8 mtr.	für Elektrozaun	für Weidezaungeräte	
						
# 44605 € 3,70	# 44606 € 3,70	# 441603 € 2,60	# 44616 € 5,30	Füttern verboten € 1,90	9V / 55 AH € 18,90	9V / 130 AH € 31,50 9V / 170 AH € 39,90

Erdungspfahl	Zaun-/Erdkabel	Erdkabel	Zaunschalter	Zaunprüfer	Zaunprüfer
verzinkter T-Stahl	mit M8 Anschlußösen	verzinnete Kupferader	Umschalter von 2 Zäunen	Messung ohne Erdspieß	6 stufig # 44661
					
1 mtr. # 44615 € 7,60 2 mtr. #441369 € 15,20	3 mtr. # 44635 € 7,20 10 mtr. # 44936 € 14,20	25 mtr. # 44630 € 20,50 50 mtr. # 44632 € 35,70	# 44607 € 7,20	mit LED-Anzeige #442326 0V - 10000V € 18,90	1000V - 10000V € 10,60

Weidezaunpfähle		
		€
44491	Kunststoffpfahl 1050 mm Ako/Kerbl	1,50
44491	<b>Sonderpreis ab 100 Stück</b>	1,30
10653	Kunststoffpfahl 1050 mm Premium	1,95
10653	<b>Sonderpreis ab 30 Stück</b>	1,80
10655	Kunststoffpfahl 1500 mm Premium	2,50
10655	<b>Sonderpreis ab 30 Stück</b>	2,30
10676	Recycling-Pfahl 1500 mm x 45 Ø	3,90
10677	Recycling-Pfahl 1700 mm x 60 Ø	7,70
10678	Recycling-Pfahl 2000 mm x 70 Ø	13,90
44469	Recycling-Pfahl 2200 mm x 100 Ø	24,90
441820	<b>Holzpfahl</b> Octo-Wood 1500 x 60 Ø	6,20
441821	<b>Holzpfahl</b> Octo-Wood 2000 x 60 Ø	8,40
441822	<b>Holzpfahl</b> Octo-Wood 1800 x 80 Ø	10,50
441823	<b>Holzpfahl</b> Octo-Wood 2000 x 80 Ø	11,90
441825	<b>Holzpfahl</b> Octo-Wood 2000 x 100 Ø	16,50

EURO NETZ		
1 Rolle = 50mtr. 14 Pfähle mit Doppelspitze	€	mit starren Senkrechten
Euro-Netz 90 cm	92,90	99,90
Ersatzpfahl 90 cm	3,90	
Euro-Netz 106 cm	109,90	119,90
Ersatzpfahl 106 cm	4,90	
Euro-Netz 120 cm	129,90	
Euro-Geflügelnetz 112 cm	139,00	

Weidezaun System T-Post und Zubehör			
	Zaunanfangs-Set	Ecklösungs-Set	
			
	#441178 € 15,20	#441177 € 25,50	
	Kopfisolator 441267	Seilisolator 441189	
			
10 St. Pack. € 7,90	25 St. Pack. € 8,75		
Ringisolator 441180	Bandisolator 441183		
			
25 St. Pack. € 8,75	25 St. Pack. € 10,50		
Abstandisolator 442343	Pinlock 441187		
			
je Stück € 0,60	25 St. Pack. € 10,50		
<b>Zaunpfähle System T-Post</b>	Bandtorgriffisolator	Torgriffisolator-Set 4 Stück Pack	
Nr.	Höhe	€	
441460	152 cm	€ 6,40	
441407	167 cm	€ 6,80	
441461	182 cm	€ 7,40	
441462	213 cm	€ 8,30	
#441494 € 9,90	#441231 € 9,80		

Sicherheitsstiefel Bekina mit Stahlkappe				Dunlop Purofort m. Stahlkappe			Dunlop	Einlegesohle
bis -20 Grad	bis -30 Grad	bis -40 Grad	bis -50 Grad	bis -20 Grad	bis -20 Grad	bis -50 Grad		
Easygrip	StepliteX Solidgrip	X Thermoprotec	Thermo-Lite	Purofort S5	Purofort S5 Plus	Thermo Plus	Blizzard o. Stahlkappe	Dunlop Premium passend für Plus und Thermo
Gr. 36-48	Gr. 36-49	Gr. 37-48	Gr. 39/41	Gr. 37-48	Gr. 36-49	Gr. 37-48	Gr. 36-48	Gr. 37 - 49
€ 62,50	€ 73,90	€ 89,50	€ 91,90	€ 67,90	€ 86,50	€ 119,90	€ 44,90	€ 15,90

Noramax	Noracomp	Noratherm	Einlegesohle	Stiefelreiniger	Gehörschutz	Gehörschutz
Safety S5	Safety S5	Safety S5				
bis -40 Grad PU-Thermo	bis -50 Grad PU-Thermo	Bekina	1/2" Wasseranschluß	Standard	Peltor Optime 2	Peltor Optime 3
Gr. 36-49	Gr. 37-49	Gr. 39-48	Gr. 37-49	€ 8,90	€ 27,90	€ 32,90
€ 57,90	€ 78,90	€ 99,90	€ 7,50	€ 165,00	Peltor Optime 1 € 23,50	

Sägekettenöl	Doppelkanister	Einfüllstutzen	Zweitaktöl	Sonderkraftstoff
				
für Benzin oder Öl	schließt automatisch bei erreichen der Füllmenge			
5 ltr. Kanister € 14,90	biologisch	Inhalt 5 + 3 Liter	1 ltr. Dosierflasche € 13,90	Hercutec
20 ltr. Kanister € 59,90	5 ltr. Kanister € 26,90	€ 24,50	5 ltr. Kanister € 49,90	5 ltr. Kanister € 27,90

Pflanzenschutz-Overall	Schutzbrille	Handschuhe	Ärmelschürze	Pflanzenschutz-Set
				
mit Kapuze Schutz PSA Kat. 3 / Typ 4 L bis XXL nach BVL-Richtlinie	EN166 Klasse B über bestehende Brille überziehbar	für Chemikalien Gr. 9 / 10	zu Tragen bei Kontakt mit Pflanzenschutzmitteln waschbar	5-teiliges Set mit Atemmaske, Ärmelschürze, Schutzbrille, Handschuhe und Spülflasche
€ 9,90	€ 3,50	€ 2,50	€ 25,90	gem. GGVS und ADR Richtlinie € 92,90

Flachstrahldüsen Lechler 120 ° Air-Injektor					Lechler Flüssigdüngerdüsen 130 °				
	<b>Bezeichnung</b>	<b>Farbe</b>	<b>Ausführung</b>	<b>€</b>		<b>Bezeichnung</b>	<b>Farbe</b>	<b>Ausführung</b>	<b>€</b>
	IDK 120-03	blau	Einfach - Kunststoff	5,50		FD-03	blau	Kunststoff	13,90
	IDK 120-04	rot	Einfach - Kunststoff	5,50		FD-04	rot	Kunststoff	13,90
	IDK 120-05	braun	Einfach - Kunststoff	5,50		FD-05	braun	Kunststoff	13,90
	IDKT 120-03	blau	Doppelflachstrahldüse	10,50		FD-06	grau	Kunststoff	13,90
	IDKT 120-04	rot	Doppelflachstrahldüse	10,50		FD-08	weiß	Kunststoff	13,90
	IDKT 120-05	braun	Doppelflachstrahldüse	10,50		FD-10	hellblau	Kunststoff	13,90

Schmierseife	Handwaschpaste	Orlin flüssig	Industriererstäuber	Melk- und Waschschrürze
# 151176	500 ml Dose	10 ltr. Eimer	mit Doppelhub	Premium mit Taschen
			für Schmiermittel und Bremsenreiniger geeignet	
5 kg € 23,50	€ 3,50	1 ltr. € 6,90 5 ltr. € 32,90	€ 13,95	#15617 € 28,50
				Standard 125 cm € 12,20

Arbeitshandschuhe Rindleder	Strick-Latex	Ejendals #880	Ejendals - Nitril	Premium Plus
				
Gr. 9-12 je Paar € 3,25	Sommer Handfläche Latex	Montagehandschuh		
Superbull Standard #3 ab 12 Paar € 3,00	Gr. 11 je Paar € 3,70 Superbull gefüttert #1 ab 12 Paar € 3,50	Gr. 7-11 je Paar € 3,80	Gr. 8-11 je Paar € 1,80	Gr. 7-12 je Paar € 3,20
	Handfläche Latex ab 12 Paar € 2,30	Handfläche Nylon ab 12 Paar € 3,60	mit Strickbund #722 ab 12 Paar € 1,60	mit Noppen ab 12 Paar € 2,90

Keiler Nr. 5	Keiler Forst	Power Grab	Thermo/Latex	Winter gefüttert
				
Gr. 10 Gr. 11 oder Gr. 12	Gr. 9 Gr. 10,5 oder Gr. 12	Gr. 7 - Gr. 11	Gr. 9 Gr. 10 oder Gr. 11	
je Paar € 5,80	je Paar € 8,50	je Paar € 4,95	je Paar € 4,95	Gr. 8-12 je Paar € 4,50
Rindnarbenleder ab 6 Paar € 5,40	mit Strickbund ab 6 Paar € 7,95	Winter beschichtet ab 6 Paar € 4,50	wasserabweisend #1453 ab 6 Paar € 4,50	beschichtet #1457 ab 6 Paar € 3,95

Aufhängeglied	Haken	Seilrolle	Seilrolle 6,4 to
verzinkt	verzinkt	mit beweglichen	mit Haken und
1/4" 8 mm € 8,50	8 mm € 5,20	Seitenblech	aufklappbaren Seitenblech
5/16" 10 mm € 10,90	10 mm € 6,50	bis 14mm / 5 to € 109,00	bis 12 mm Seilstärke
3/8" 11 mm € 17,50	11 mm € 7,90	bis 16mm / 10 to € 159,00	€ 209,00

Hochfeste Forstketten			
		p/mtr.	ab 10 mtr.
Forstkette rot 6 mm rund		€ 8,50	€ 7,50
Forstkette rot 8 mm rund		€ 10,50	€ 9,50
Forstkette rot 8 mm 4 kt.		€ 11,50	€ 10,50
Forstkette blau 8 mm 4 kt.		€ 15,90	€ 14,90
Forstkette rot 10 mm rund		€ 15,90	€ 14,90

Haken rot mit Gabel u. Bolzen	Haken rot mit Öse	Schlinghaken	Lasthaken m. Sicherung	Aufhängeglied mit Gabel rot	Verkürz.-klau rot	Verbind.-glied rot	Seilgleit-haken	
für Forst nur rote u. blaue Artikel zugelassen			rot					
6 mm	€ 6,20	€ 5,90	€ 6,90	€ 7,50	€ 9,30 1120 kg	6 mm € 11,50	6 mm 6,90	rot
8 mm	€ 7,90	€ 7,90	€ 7,90	€ 8,50	€ 10,50 2000 kg	8 mm € 16,90	8 mm 9,90	mit
10 mm	€ 16,90	€ 10,90	€ 12,90	€ 14,90	€ 15,90 3150 kg	10 mm € 19,90	10 mm 10,90	Sicherung
11 mm			rot	blau				
13 mm	€ 26,90	€ 16,50	Güte 8.8	Güte 10.9	€ 29,50 5300 kg			€ 12,50
16 mm								€ 19,50

Seilgleitbügel		Seilrolle	Seilhaken
Standard	drehbar	drehbar	mit Gabel
8 mm rot € 8,90	rot	blau	8 mm blau
8 mm blau € 11,90	8 mm	8 mm € 19,90	6000 kg
10 mm rot € 17,90	€ 14,90	10 mm € 24,50	8 mm
			€ 16,90

Aufhängeglied		
oval rote Ausführung		
Ø	Länge	€
13	130 mm	5,90
16	130 mm	6,90
18	170 mm	9,80
22	200 mm	13,90

Chokerkette 8 mm		
2,0 mtr.	vierkant rot	€ 34,90
2,5 mtr.	vierkant rot	€ 39,90
2,0 mtr.	vierkant blau	€ 43,90

Spannschlösser		
verzinkt		
	Haken + Öse	2 Ösen
	€	€
M 6	1,50	1,50
M 8	1,90	1,90
M 10	2,90	2,90
M 12	4,40	4,40
M 16	5,90	5,90
M 20	11,90	11,90
M 24	24,50	24,50

Schäkel		
	gerade	geschweifft
	€	€
6 mm	0,50	
8 mm	0,60	0,60
10 mm	0,90	0,90
11 mm	1,10	1,10
13 mm	1,30	1,30
16 mm	2,40	
20 mm	4,50	

Schäkel hochfest		
	Tragfähigkeit	€
11 mm	1,0 to	2,40
13 mm	1,5 to	2,80
16 mm	2,0 to	3,60
19 mm	3,2 to	6,50
22 mm	4,7 to	9,90
27 mm	6,5 to	13,50

	Schraubglieder	Karabinerhaken	Notglieder
4 Ø 10 St.		4,50	2,00
5 Ø 10 St.		6,00	5,00
6 Ø 10 St.		6,00	5,00
7 Ø 10 St.		8,00	5,50
8 Ø 10 St.		9,00	7,00
10 Ø 1 St.		1,40	0,95
12 Ø 1 St.		2,60	1,80

	Seilklemme	Kauschen	Taluritklemme
5 mm/10 Stück	2,00	4,00	7,00
6 mm/10 Stück	2,50	4,50	9,50
8 mm/10 Stück	3,50	5,00	13,00
10 mm/ 1 Stück	0,40	0,75	2,00
11 mm/ 1 Stück	0,60	0,75	2,60
12 mm/ 1 Stück		0,80	3,20
13 mm/ 1 Stück	0,80	0,85	3,80
14 mm/ 1 Stück	0,75	0,95	4,80
16 mm/ 1 Stück	0,95	1,40	8,50

Drahtseil verzinkt		
		€
2 mm		€ 0,50
3 mm		€ 0,70
4 mm		€ 0,90
5 mm		€ 1,00
6 mm		€ 1,20
8 mm		€ 2,10
10 mm		€ 2,50
12 mm		€ 3,90
Edelstahl V4A 6 mm		€ 3,20
Edelstahl V4A 8 mm		€ 4,70
Edelstahl V4A 10 mm		€ 5,70
Seilklemme V4A 8 mm		€ 2,40
Seilklemme V4A 10 mm		€ 3,90

Spaltkeile		
Alu/Holz-Keil kpl.		€ 44,50
Ersatzring		€ 9,50
Holz lose		€ 5,50
Stahlkeil 2000 gr.		€ 18,50
Alu-Massivkeil 22x5 cm		€ 34,50
Fällkeil-Alu 12x4 cm		€ 7,90
Fällkeil-Nylon 24x7 cm		€ 11,90

Holzaxt Org. Freund mit lackiertem Stiel		
Küchenbeil 600 gr.		€ 23,50
Küchenbeil 800 gr.		€ 26,50
Holzaxt 1250 gr.		€ 36,50
Holzaxt 1400 gr.		€ 42,90
Holzaxt 1600 gr.		€ 45,90
Spaltaxt 2000 gr.		€ 66,90

Handpackzange	Verladezange	Hand - Sappie	Baumgurt	Fällheber 3,4 kg	Messkluppe
550 gr. Öffnung 190 mm € 37,50	2000 kg Öffnung 700 mm € 199,00	40 cm Stiel lose € 34,90 80 cm Stiel lose € 43,90 € 11,90	2000 x 90 mm 3 to / 6 to € 12,50	Länge 1,3 mtr. € 119,00	bis 50 cm € 48,50

Forstseil 1 Schlaufe 1770N/mm <sup>2</sup>	Forstseil hochverdichtet	Seil-Endstück	Forst-Maßband
schwarz 6 x 36 Drähte	schwarz 6 x 36 Drähte mit 1 Schlaufe	blau Standard € 28,50	Spencer
10 mm / 70 mtr. € 229,00	10 mm Bruchlast 98 KN		15 mtr. € 64,50
11 mm / 70 mtr. € 265,00	70 mtr. / 80 mtr. Rolle € 309,00 / € 349,00		20 mtr. € 79,50
11 mm / 80 mtr. € 299,00	11 mm Bruchlast 118 KN		
12 mm / 60 mtr. € 248,00	70 mtr. / 80 mtr. Rolle € 369,00 / € 419,00		
12 mm / 70 mtr. € 289,00	12 mm Bruchlast 137 KN		
	70 mtr. Rolle € 405,00	blau drehbar € 39,50	

# Scheinwerfer / Fahrzeug-Beleuchtung

## LED - Arbeitsscheinwerfer 12/24 Volt funkentstört

110 x 110 mm #28542	110 x 110 mm #129483	110 x 110 mm #28768	110 x 60 mm #112525	für Spritzgestänge
				<b>blaues Licht</b> 
<b>Zulassung Rückfahrcheinwerfer</b>				100 x 100 mm
5x3W / 1150 Lumen € 21,90	9x3W / 2070 Lumen € 19,90	16x3W / 3600 Lumen € 45,90	2x10W / 2000 Lumen € 39,90	9x5W / 400 Lumen € 44,90

LED-Einbauscheinwerfer pass. f. Fendt u. Case	85 mm rund	130 mm rund	142 x 90 mm oval	142 x 90 mm oval	mit Halter	Halter für Handlauf
30x2W / 3280 Lumen € 56,50	4x7W / 3400 Lumen € 41,90	8x5W / 3180 Lumen € 59,90	8x3W / 1800 Lumen #28767 € 42,90	8x3W / 3000 Lumen #112527 € 59,90	8x3W / 1800 Lumen € 54,00	23 - 28 mm € 17,90

## Rundumleuchte

Standard	Gummifuß flexibel	mit Magnet	LED flexibler Fuß	LED zum aufschrauben	Halter
12 Volt € 27,50 24 Volt € 29,90	12/24 Volt € 29,90 LED 12/24V € 34,90	12 Volt € 34,90 24 Volt € 39,50	umschaltbar Einzelblitz Doppelblitz Rotationslicht 120 Blitze ECE Reg 10 ECE Reg 65 12 / 24 Volt € 69,90	umschaltbar Einzelblitz Doppelblitz Rotationslicht 120 Blitze ECE Reg 10 ECE Reg 65 12 / 24 Volt € 79,90	Aufsteckrohr € 8,95 mit Winkel € 9,50

## Rückleuchten

1.	2.	3.	4.	5.
	<b>Maße</b>	<b>ohne Birnen</b>	<b>mit Birnen</b>	<b>Ersatzglas</b>
1.	3-K. für Flachstecker 95x 90mm	6,60	8,30	3,90
2.	3-Kammer ital. Ausf. 110x105mm	7,90	9,50	3,90
3.	2-Kammer Geka Ia 85x 95mm	6,95	8,60	5,20
4.	3-Kammer Geka Ia 120x120mm	8,90	10,60	5,20
5.	3-Kammer mit LED 115x115mm	24,50		
6.	pass. für Fendt rund 140mm Ø	13,90	15,50	11,50
7.	pass. für Case/J. Deere 170x 75mm	19,50	21,20	11,50
8.	pass. für Fendt/KHD 90x 95mm	16,90	18,60	12,90
9.	pass. für Fendt/KHD 64x158mm	13,90	15,40	10,90
6.	7.	8.	9.	

## Positions- und Kennzeichenleuchte

11.	12.	13.	14.	15.
	<b>Maße</b>	<b>€</b>	<b>Ersatzglas</b>	
11.	2-Kammer weiß/gelb 120x80mm	13,90	5,90	
12.	2-Kammer für Fendt 84x84mm	13,50	9,90	
13.	weiß oder rot eckig 60x60mm	10,50	3,95	
14.	weiß rund 80mm	8,20	2,90	
15.	rot/weiß 90x40mm	6,90		
16.	rot/weiß / Gummigeh.		9,90	
17.	rot/weiß / Gummiarm 190mm lg.		19,90	
18.	Kennzeichenleuchte 80x30mm		4,50	
19.	Kennzeichenleuchte 100x50mm		4,50	
19.	Kennzeichenleuchte LED		7,90	
16.	17.	18.	19.	





## Rückleuchte Multipoint 2

			<b>pass. f. Fendt rechts oder links</b>	<b>Blinkleuchte</b>	<b>Kotflügelleuchte</b>
240 x 140 mm	240 x 140 mm				
kpl. links oder rechts € 20,50	Ersatzglas lose € 16,50	Stecker links € 6,50 Stecker rechts € 6,50	Leuchte kpl. € 39,90 Ersatzglas € 29,90	100 x 50 mm für seitlichen Anbau € 7,90	160 x 85 mm € 12,90

## Anhänger - Beleuchtungssatz fertig verkabelt





Standard	mit Magnethalter	LED Leuchten	<b>Org. GEKA</b>	<b>Connix</b>	<b>Stangenleuchte</b>
			7,5 mtr. Kabel	Funk kabellos aufladbar	
7,5 mtr. Kabel € 29,90	7,5 mtr. Kabel € 30,90	7,5 mtr. Kabel	mit 7-poliger Dose und Dreieckstrahler € 68,00	mit Magnet LED 12/24 Volt € 99,00	von 1,2 mtr -1,7 mtr. verstellbar
12 mtr. Kabel € 34,90	12 mtr. Kabel € 38,90	€ 43,50			7,5 mtr. Kabel ohne Dose € 39,90 7,5 mtr. Kabel mit Dose € 42,50 7,5 mtr. Kabel LED € 49,90



# Warntafeln / Elektrik

Warntafelsatz beidseitig mit Beleuchtung	Warntafelsatz einseitig mit Beleuchtung	Befestigung für Warntafeln	Warntafel 425 x 425 mm groß Blechrücken verzinkt	Warntafel 283 x 283 mm klein mit Typ 3 Folie
 2 Tafeln Folie 2-seitig mit Positions- und Rückleuchten	 2 Tafeln Folie 1-seitig für Anbau hinten mit Rückleuchten			
5 mtr. Anschlußkabel	5 mtr. / 3,5 mtr. Kabel	Winkeleisen € 2,40	1-seitig beklebt € 12,90	1-seitig beklebt € 13,50
3,5 mtr. Verbindungskabel	kpl. mit Beleuchtung € 78,50	Halter links € 5,90	2-seitig beklebt € 18,90	2-seitig beklebt € 21,50
kpl. mit Beleuchtung € 92,90	kpl. mit LED-Leuchten € 119,00	Halter rechts € 5,90	Folie zum kleben € 7,50	Folie zum kleben € 8,90



Konturenband	Rückstrahler gelb / weiß / rot	Dreieckstrahler	Sort. Ader-Endhülsen	Fahrzeugkabel
				
Lieferbar in rot - gelb - weiß	rund 60 mm Ø € 0,85	Kunststoff € 1,20	400 St. 0,5mm <sup>2</sup> -2,5mm <sup>2</sup> isoliert € 29,90	1,5 mm <sup>2</sup> per mtr. € 0,70
per mtr. € 2,95	rund 80 mm Ø € 1,50	Blechrücken € 4,40	Sortiment	2,5 mm <sup>2</sup> per mtr. € 0,95
ab 50 mtr. € 2,50	eckig 90x40mm € 1,50	Gummipendel € 4,90	210 St. 0,25mm <sup>2</sup> -2,5mm <sup>2</sup>	
	eckig 180x40mm € 2,20		mit Zange und Schraubendreher € 42,90	lieferbar in schwarz / rot / blau









Zwischenkabel mit 2 Stecker / 7-polig	Spiralkabel mit 2 Stecker / 7-polig	Verlängerungskabel	Fahrzeugkabel mehradrig	
				
2,8 mtr. Plastikstecker € 15,90	2,8 - 4 mtr. ausziehbar	mit Stecker und Dose 7-polig	2x1,5 mm <sup>2</sup> € 1,60	5x1,5 mm <sup>2</sup> € 2,40
3,0 mtr. Alustecker € 21,90	mit Alustecker	3,5 mtr. lang € 20,90	3x1,5 mm <sup>2</sup> € 1,80	7x1,5 mm <sup>2</sup> € 3,80
3,5 mtr. Alustecker € 22,50	€ 49,90	7,5 mtr. lang € 24,50	4x1,5 mm <sup>2</sup> € 2,00	ab 50 mtr. € 3,50

Stecker		Steckdose			Adapterstück	Steckdosentester
						
7-polig Alu € 3,60	2-polig Plastik € 3,20	7-polig Alu € 3,80	2-polig Einbau € 5,50		für 7-polige	
7-polig Plastik € 2,80	2-polig m. Hülse € 3,90	7-polig Plastik € 3,30	2-polig Aufbau € 8,40	13 - 7 Pole € 8,90	Stecker und Dosen	
mit Flachstecker € 2,90	3-polig / 25A € 6,20	mit Flachstecker € 5,90	3-polig / 25A € 6,40	7 - 13 Pole € 10,90	incl. Batterie	
13-polig Plastik € 7,50		13-polig Plastik € 9,50	7-polig f. Kabel € 6,50		€ 23,50	

Kabelbinder 100 Stück Packung		Leitungsverbinder	
			
140 x 3,5 mm € 5,90	360 x 4,8 mm € 13,50	#51248 12-polig 2,5mm <sup>2</sup> € 1,60	
200 x 3,5 mm € 8,90	375 x 7,6 mm € 21,50	#51249 12-polig 6mm <sup>2</sup> € 1,80	
290 x 4,8 mm € 10,90	450 x 7,8 mm € 28,50	#51250 12-polig 10mm <sup>2</sup> € 2,10	

Kabeldose	Isolierband	Hupe
		
10 - polig mit Deckel € 6,90	15 mm / 10 mtr. € 1,40 ab 10 Rollen € 1,20	12 Volt € 9,80

Kippschalter	Zug- schalter	Druck- schalter	Bremslicht- schalter
			
2-polig € 3,50	3-polig € 3,50	3-polig € 8,95	# 11325 € 3,50
			für Hupe € 4,50
			mit Feder € 5,95





Ersatzlampen				
			12 Volt	24 Volt
1.				
2.				
3.				
4.				
1.	Kugelbirne	5 Watt	0,55	0,90
1.	Kugelbirne	10 Watt	0,55	0,90
1.	Kugelbirne	18 Watt	0,55	0,90
1.	Kugelbirne	21 Watt	0,55	0,90
2.	Zweifadenbirne	5/21 Watt	0,60	1,30
3.	Bilux P45 T	45/40 Watt	2,00	
3.	Bilux-Lampe	35/35 Watt	3,00	
4.	Soffitte	5 Watt	0,55	
4.	Soffitte	10 Watt	0,55	
5.	Soffitte	18 Watt	0,55	
4.	Soffitte	21 Watt	0,75	
5.	Halogen H1	55 Watt	2,95	4,60
6.	Halogen H3	55 Watt	2,95	4,60
7.	Halogen H4	55/60 Watt	2,95	6,40
8.	Halogen H7	55 Watt	4,90	6,90
9.	Halogen H9	65 Watt	12,50	PGJ 19-5
9.	Halogen f. J.D.	50 Watt	6,90	PGJ 13
5.				
6.				
7.				
8.				
9.				

# Elektrik / Hydraulikzubehör

Sicherungen		
		
1.	2.	3.
4.		
1.	Flachsicherung Standard je Stück 5 / 7,5 / 10 / 15 / 20 / 25 / 30 Amp.	€ 0,25
1.	Sortiment 5-30 Amp. / 35 Stück #173306	€ 6,90
1.	Sortiment 3-30 Amp. / 93 Stück #29891 im Kunststoffkasten mit Prüflampe	€ 15,90
2.	Halter für Flachsicherung mit Kabel	€ 2,90
3.	Sicherungsgehäuse 8-fach #79058	€ 16,90
4.	Sicherungsgehäuse 4-fach #11946	€ 8,50
5.	Mini-Flachsicherungen 5 - 30 Amp. je Stück	€ 0,30
5.	Sort. Mini-Flachsicherungen 21 St. #172901	€ 8,80
5.	Mini-Flachsicherungen im Kasten 93 Stück	€ 13,50
6.	Maxi-Flachsicherungen je Stück 40 / 50 / 60 / 70 / 80 / 100 Ampere	€ 1,40
7.	Sortiment 5-25 Amp. alt rund / 20 Stück	€ 3,90
8.	Sicherungsgehäuse für runde Sicherungen	€ 2,00
		
5.	6.	7.
		
8.		

Flachstecker - Kabelschuhe - Quetschverbinder		
		
		
		
		
		
		
		
Art.Nr.	Packung a 25 Stück	
163577	Flachsteckhülse rot 0,5 - 1,5 mm <sup>2</sup>	€ 4,80
163597	Flachsteckhülse blau 1,5 - 2,5 mm <sup>2</sup>	€ 4,60
163576	Flachsteckhülse gelb 2,0 - 6,0 mm <sup>2</sup>	€ 5,80
163581	Flachsteckhülse rot kpl. isoliert	€ 5,90
163598	Flachsteckhülse blau kpl. isoliert	€ 5,90
163607	Flachsteckhülse gelb kpl. isoliert	€ 5,50
163611	Flachstecker rot 0,5 - 1,5 mm <sup>2</sup>	€ 4,70
163599	Flachstecker blau 1,5 - 2,5 mm <sup>2</sup>	€ 5,90
163608	Flachstecker gelb 2,0 - 6,0 mm <sup>2</sup>	€ 5,10
163583	Rundstecker rot 0,5 - 1,5 mm <sup>2</sup>	€ 5,20
163602	Rundstecker blau 1,5 - 2,5 mm <sup>2</sup>	€ 4,60
163582	Rundsteckhülse rot 0,5 - 1,5 mm <sup>2</sup>	€ 5,40
163601	Rundsteckhülse blau 1,5 - 2,5 mm <sup>2</sup>	€ 4,60
163579	Quetschkabelschuh rot 0,5 - 1,5 mm <sup>2</sup>	€ 4,30
163595	Quetschkabelschuh blau 1,5 - 2,5 mm <sup>2</sup>	€ 4,50
163604	Quetschkabelschuh gelb 2,0 - 6,0 mm <sup>2</sup>	€ 6,80
12415	Verbinder-Röhrchen rot 0,5 - 1,5 mm <sup>2</sup>	€ 4,60
8578	Verbinder-Röhrchen blau 1,5 - 2,5 mm <sup>2</sup>	€ 4,10
172950	Abzweigverbinder rot 0,5 - 1,5 mm <sup>2</sup>	€ 3,60
172949	Abzweigverbinder blau 1,5 - 2,5 mm <sup>2</sup>	€ 6,90
172951	Abzweigverbinder gelb 2,0 - 6,0 mm <sup>2</sup>	€ 6,00
	Kabelschuhzange Knipex 240 mm lg.	€ 24,90
172981	Sortiment Kabelschuhe 80 Stück	€ 12,80
29904	Sortiment Kabelschuhe 260 Stück	€ 21,90

Spannungsprüfer Elora	Automatik-Kabeltrommel	Kraftstrom-Kabeltrommel Hedi Primus
		
6 V / 12 V / 24 V	Hedi 230 Volt / 15 mtr.	Hedi Primus mit 25 mtr. Kabel
€ 8,40	€ 135,00	€ 185,00
220 Volt		
€ 3,20		

CEE-Stecker	CEE-Kupplung	CEE-Wanddose	Phasenwender	Stecker 220 V	Kupplung 220 V
					
5 x 16 Amp € 6,50	5 x 16 Amp € 7,50	5 x 16 Amp € 7,90	5 x 16 Amp € 14,90	für Kabel	für Kabel
5 x 32 Amp € 6,95	5 x 32 Amp € 8,50	5 x 32 Amp € 8,90	5 x 32 Amp € 17,90	€ 2,90	€ 4,95

Kraftstrom-Verlängerungskabel	Verlängerungskabel	Kabeltrommel Hedi
		
9,5KW 16 Amp 5x1,5mm <sup>2</sup>	für den Einsatz im Freien zugelassen gem. BGI 608	3x230 Volt-Steckdosen mit Klappdeckel, m. Thermoschutzschalter, TÜV/GS, rotes Kabel zugelassen für den Einsatz im Freien
10 mtr. € 47,50	220 V / 10 mtr. € 25,90	40 mtr. Kabel 3x1,5mm <sup>2</sup> Kunststoffgehäuse € 99,50
25 mtr. € 89,90	220 V / 25 mtr. € 48,90	30 mtr. Kabel 3x2,5mm <sup>2</sup> Kunststoffgehäuse € 129,00
12KW 32 Amp 5x2,5mm <sup>2</sup>		
10 mtr. € 69,00		
25 mtr. € 139,00		
19,5KW 32 Amp 5x4,0mm <sup>2</sup>		
10 mtr. € 109,00		
25 mtr. € 239,00		

Hydraulik - Zubehör										
	<b>Schraubstecker</b>	€		<b>Verbindung</b>	€		<b>Innen x Außen Ø</b>	<b>Nr.</b>	<b>für Schlauchbund</b>	<b>p/mtr.</b>
	BG3 / M18x1,5	19,50		M14x1,5	7,90		16 x 20 mm	4564	16 - 26 mm	3,60
	BG3 / M22x1,5	19,50		M16x1,5	7,90		20 x 25 mm	4565	20 - 27 mm	5,20
				M18x1,5	7,90		27 x 32 mm	4566	27 - 35 mm	6,90
	Staubkappe	3,60		M22x1,5	9,50		35 x 40 mm	4567	35 - 60 mm	9,20
	<b>Schraubmuffe</b>	€		<b>Reduzierverschraubung</b>	€		56 x 63 mm	4966	50 - 90 mm	10,50
	BG3 / M18x1,5	17,90		M18xM16	4,50		<b>Kupplungsmuffe Push-Pull Org. FASTER</b> unter Restdruck kuppelbar passend für			
	BG3 / M22x1,5	17,90		M22xM18	4,90		Case NH / Fendt / John Deere / MF	Deutz-Fahr / Lamborghini / Steyr		
	Staubkappe	3,60		<b>Umschaltventil</b>	€			<b>FASTER</b>		<b>FASTER</b>
	<b>Drosselventil</b>	€		6/2 Wege 1/2"	815794		M22 x 1,5 / 95 lg.	€ 59,00	M22 x 1,5 / 80 lg.	€ 69,00
	Anschluß 1/2"	47432		Durchfluss max. 50 ltr.	239,00					
	Durchfluss max. 50 ltr.	67,50								

## Kreuzgarnitur komplett

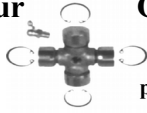

passend für:

dt. Nr.	it. Nr.	mm	€
10.01	1.41	22x 54	10,50
11.03	3.41	27x 70	13,90
12.00		34x 90	39,00
19.00		18x 47	17,00
20.00	2.41	24x 61	11,90
21.00	4.41	27x 75	13,50
	5.41	30x 80	25,90
22.00	6.41	30x 92	29,50
23.00	7.41	30x106	29,50
S 2499	7.81	35x 94	36,00
24.00	8.41	35x106	31,50
	9.41	41x108	55,90
	10.41	41x118	67,50
24.01		35x106	28,00
25.00		40x116	55,00
26.00		42x104	99,00
30.41		29x 80	39,00
35.00		32x 76	20,90
36.00		36x 89	27,50
20.06	22/24	76x 61	31,80
21.06	24/27	91x 75	41,50
35.06	27/32	94x 76	49,90
36.06	32/36	106x 89	74,50

## Gelenkwellen-gabel

passend für:

		€
10.10.00	6 Z	24,90
10.48.00	23,5	24,90
10.49.00	30,0	24,90
20.10.00	6 Z	33,90
20.11.00	34,5	33,90
20.12.00	41,0	33,90
21.10.00	6 Z	36,50
21.11.00	34,5	36,50
21.12.00	41,0	36,50
35.10.00	6 Z	54,90
35.13.00	39,5	54,90
35.14.00	48,0	54,90



## Gelenkwellen Weasler



pass. für System Walterscheid					
BG	Kreuz	Rohre	Länge	€	
21000	10.01	00A/0A	760 mm	118,00	
22000	20.00	0V/1	760 mm	139,00	
23000	21.00	0V/1	760 mm	159,00	
24000	35.00	1b/2a	1010 mm	269,00	
25000	36.00	Stern	1010 mm	595,00	
mit Freilauf rechts (für hinten)					
23000	21.00	0V/1	1010 mm	389,00	
24000	35.00	1b/2a	1010 mm	449,00	
25000	36.00	S4/S5	1010 mm	769,00	
mit Freilauf links (für vorne)					
24000	35.00	1b/2a	1010 mm	479,00	
mit Überlastkupplung Sternratsche					
900 Nm	21.00	0V/1	1010 mm	415,00	
1200 Nm	35.00	1b/2a	1010 mm	509,00	
pass. für System Bondioli					
BG 1	1.41		610 mm	69,00	
BG 1	1.41		800 mm	84,00	
BG 2	2.41	2.03	800 mm	89,00	
BG 4	4.41	3.03	800 mm	99,00	
BG 4	4.41	3.03	1000 mm	105,00	
BG 6	6.41	6.03	1000 mm	139,00	
BG 8	8.41	8.03	1000 mm	219,00	

## Weitwinkel-Gelenkwellen 80 Grad Fabr. Weasler



passend für:

einseitig Weitwinkel			€
23800	21.00 OV/1	860 mm	449,00
23800	21.00 OV/1	1010 mm	529,00
24800	35.00 1b/2a	1010 mm	795,00
24800	35.00 1b/2a	1210 mm	795,00
25800	36.00 S4/S5	1010 mm	1399,00
m. Weitwinkel und Überlastkupplung			
23800 900 NM	21.00 OV/1	1010 mm	819,00
24800 1200 NM	35.00 1b/2a	1210 mm	1379,00
mit Weitwinkel und Scherbolzen 2900 NM			
24800	35.00 S4/S5	1010 mm	1179,00



## Zapfwellenverlängerung

einfach 6 Z 1 3/8" € 31,50  
 verstärkt 6 Z ab 80 PS € 79,00  
 innen 21 Z außen 6 Z € 83,50  
 20 Z / 1 3/4" außen 6 Z € 149,00

## Gelenkwellenschutz passend für:



## Sicherungskettchen lose € 2,25

Ringe innen Ø Walterscheid	ital. System	Länge mm	€	Laufri-Satz
Gr. 1 41 mm	40/47	800	62,50	7,90
Gr. 1 41 mm	40/47	1200	66,90	7,90
Gr. 2 50 mm	47/53	1200	62,50	11,50
Gr. 3 63 mm	53/62	800	85,90	14,50
Gr. 3 63 mm	59/68	1200	85,90	15,20
Gr. 4 82 mm	68/80	800	135,00	15,50

## Profilrohre

passend für Walterscheid



Typ	00A	0A	0V	1B	1	2A
Maß A	23,5 mm	30 mm	34,5 mm	39,5 mm	41 mm	48 mm
Stärke S	4 mm	3 mm	4 mm	4,5 mm	3 mm	4 mm
€/mtr.	32,50	32,50	39,50	43,50	36,50	53,50

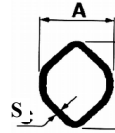

## Profilrohre

für italienische Gelenkwellen

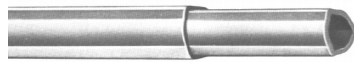

Typ	2.04	2.03	3.03	4.04	5.04	7.04	5.03	6.03	8.04	9.04	8.03	9.03
Maß C	29 mm	36 mm	43,5mm	36 mm	45 mm	45 mm	52 mm	54 mm	54 mm	54 mm	63 mm	66 mm
Stärke S	4,1 mm	3,2 mm	3,4 mm	3,9 mm	3,9 mm	5,4 mm	3 mm	4,5 mm	4,9 mm	5,9 mm	4,1 mm	5,7 mm
€/mtr.	34,50	36,50	42,50	49,00	56,00	74,00	49,50	69,00	99,00	179,00	99,00	235,00

## Sternprofil pass. f. Walterscheid

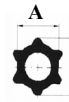

Typ	S4	S5
Maß A	37 mm	47 mm
Maß B	51 mm	61 mm
€/mtr.	135,00	115,00

## Hydraulik

	Stecker Außengewinde		€
	10 L	M16x1,5	6,80
	12 L	M18x1,5	6,80
	Stecker Schottgewinde		
	12 L	M18x1,5	8,60
	15 L	M22x1,5	8,60
	Stecker Innengewinde		
	10 L	M16x1,5	5,90
	12 L	M18x1,5	5,90
	Doppelrippel		
	10 L	M16x1,5	1,70
	12 L	M18x1,5	1,95
	Winkel		
	10 L	M16x1,5	5,70
	12 L	M18x1,5	5,90
	T-Stück		
	10 L	M16x1,5	6,70
	12 L	M18x1,5	8,10
	Stecker Flachverschluß		
	19,8mm Ø	M18x1,5	22,90
	24,5mm Ø	M22x1,5	31,90
	Parkdose für Stecker		9,20
	Staubkappen f. Stecker		1,30

## Hydraulik

	Muffen Außengewinde		€
	10 L	M16x1,5	16,90
	12 L	M18x1,5	16,90
	Muffen Schottgewinde		
	12 L	M18x1,5	18,90
	15 L	M22x1,5	18,90
	Muffen Innengewinde		
	12 L	M18x1,5	13,90
	15 L	M22x1,5	13,90
	Verschraubung		
	10 L	M16x1,5	2,70
	12 L	M18x1,5	2,90
	Winkel einstellbar		
	10 L	M16x1,5	5,70
	12 L	M18x1,5	7,40
	T-Stück einstellbar		
	10 L	M16x1,5	9,90
	12 L	M18x1,5	10,50
	Muffen-Flachverschluß		
	19,8mm Ø	M18x1,5	46,50
	24,5mm Ø	M22x1,5	66,90
	Dichtungssatz f. Muffen		0,80
	Staubkappen f. Muffen		1,30
	dto. mit Klapptdeckel		4,50
	dto. mit Arretierung		4,50

## Gummi-Hydraulikschlauch 2lagig

Länge	M 16x1,5	M 18x1,5	M 22x1,5
300 mm	10,70	10,80	13,40
400 mm		10,90	14,60
500 mm	11,50	11,80	15,40
600 mm	12,90	11,80	15,90
800 mm	12,90	12,90	17,40
1000 mm	14,20	14,40	18,70
1200 mm	15,00	15,60	20,90
1300 mm		16,30	20,90
1500 mm	17,00	17,90	22,50
1600 mm		18,90	22,80
1800 mm	17,90	19,90	24,50
2000 mm	19,90	20,90	26,90
2200 mm		23,30	27,50
2500 mm	22,60	23,90	30,90
3000 mm		27,80	33,50
3500 mm		30,80	36,90
4000 mm		34,50	40,90
5000 mm		39,80	49,90
6000 mm		46,50	
8000 mm		63,50	
Hydraulik Rohr	10 L	12 L	15 L
	8,90	9,90	11,50
Rohrschellen	3,90	3,90	einfach
Rohrschellen	4,60	5,40	doppelt
Schneidring mit Mutter	M 18x1,5	M 22x1,5	
	1,20	1,40	

## Zweiwege-Absperrhahn

M18x1,5 € 24,90  
 M22x1,5 € 27,50



## Dreiwege-Hydraulikhahn

M18x1,5 € 39,90  
 M22x1,5 € 41,90

# Oberlenker / Splinte / Spannstifte

## Hydraulischer Oberlenker

Sperrblock seitlich  
mit Fanghaken CBM  
und Kugelaug



kpl. mit Hydraulikschläuche

	Länge	Hub	Zylinder	Druck	Zug	€
Kat 2	580-820 mm	240 mm	63 mm	6,0 to	5,0 to	249,00
Kat 2	550-755 mm	205 mm	70 mm	6,9 to	5,2 to	369,00
Kat 2	620-920 mm	300 mm	70 mm	6,9 to	5,2 to	319,00
Kat 2	660-975 mm	315 mm	70 mm	6,9 to	5,2 to	379,00
Kat 2	700-1056 mm	356 mm	70 mm	6,9 to	5,2 to	389,00

## Hydraulischer Oberlenker

Sperrblock oben

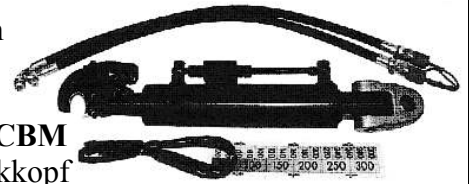

mit Fanghaken CBM  
und Gabelgelenkkopf  
kpl. mit Hydraulikschläuche

	Länge	Hub	Zylinder	Druck	Zug	€
Kat 2	650-955 mm K	295 mm	70 mm	6,1 to	5,1 to	539,00
Kat 2	700-1045 mm K	345 mm	70 mm	6,1 to	5,1 to	539,00
Kat 3	560-710 mm K	150 mm	80 mm	9,0 to	6,8 to	599,00
Kat 3	590-825 mm K	235 mm	80 mm	9,0 to	6,8 to	579,00
Kat 3	670-890 mm L	220 mm	80 mm	9,0 to	6,8 to	599,00
Kat 3	710-970 mm L	260 mm	80 mm	9,0 to	6,8 to	625,00
Kat 3	630-850 mm K	220 mm	90 mm	11,5 to	8,5 to	689,00
Kat 3	670-930 mm K	260 mm	90 mm	11,5 to	8,5 to	709,00
Kat 3	700-940 mm K	250 mm	90 mm	Org. Walterscheid		1495,00
Kat 3	700-940 mm K	250 mm	105 mm	15,5 to	12,5 to	839,00

## Oberlenker mit Fanghaken



	Gewinde	Hülsenlänge	Arbeitslänge	€
Kat 2-2	M 30	370 mm	555 - 795 mm	119,00
Kat 2-2	M 30	420 mm	605 - 845 mm	119,00
Kat 2-2	M 30	460 mm	645 - 885 mm	119,00
Kat 2-2	M 30	500 mm	685 - 925 mm	119,00
Kat 2-2	M 36	360 + 460 + 500 mm		139,00
Kat 3-3	M 36	280 mm	530 - 720 mm f. JD	235,00
Kat 3-3	M 36	320 mm	590 - 765 mm f. JD	235,00
Kat 3-3	M 36	400 mm	620 - 940 mm	159,00
Kat 3-3	M 36	460 mm	680 - 1000 mm	159,00
Kat 3-3	M 36	500 mm	720 - 1040 mm	159,00

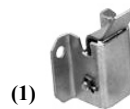

(1)

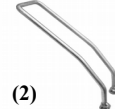

(2)

(1) Halteplatte für Oberlenker Traktorseitig #161255	12,90
(2) Haltebügel für hydr. Oberlenker #161231	18,50

## Oberlenker mit Fanghaken und Gabelgelenk 50 mm breit

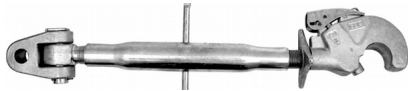

	Gewinde	Hülsenlänge	€
Kat 2-2	M 36	360 mm	165,00
Kat 2-2	M 36	400 mm	165,00
Kat 2-2	M 36	450 mm	165,00
Kat 2-2	M 36	500 mm	165,00
Kat 3-3	M 36	400 mm	179,00
Kat 3-3	M 36	450 mm	179,00
Kat 3-3	M 36	500 mm	179,00
Kat 3-3	M 36	580 mm	179,00

weiter Größen auf Anfrage lieferbar

## Oberlenker passend für Fendt mit zwei Augen - Schlepperseitig 22 mm Ø



	Gewinde	Hülsenlänge	€
Kat 2	M 30	330 + 370 mm	69,00
Kat 2	M 30	405 + 450 mm	75,00
Kat 2	M 30	510 mm	75,00

## Oberlenker passend für Fendt mit Fanghaken - Auge Schlepperseitig 22 mm Ø

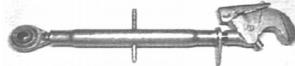

	Gewinde	Hülsenlänge	€
Kat 2	M 30	405 mm	135,00
Kat 2	M 30	450 mm	135,00
Kat 2	M 30	510 mm	135,00

## Oberlenker mit Kugelaug



weiter Größen auf Anfrage lieferbar

	Gewinde	Hülsenlänge	€
Kat 1-1	M 27	270 + 320 + 350 mm	28,90
Kat 1-1	M 27	370 + 400 + 450 mm	30,90
Kat 2-1	M 27	350 + 370 + 400 mm	31,90
Kat 2-1	M 27	430 + 470 mm	34,50
Kat 2-2	M 30	180 + 230 mm	34,50
Kat 2-2	M 30	270 + 300 mm	43,90
Kat 2-2	M 30	320 + 350 mm	44,90
Kat 2-2	M 30	400 mm	43,90
Kat 2-2	M 30	450 mm	44,90
Kat 2-2	M 30	500 mm	44,90
Kat 2-2	M 36	360 mm	64,00
Kat 2-2	M 36	400 mm	64,00
Kat 2-2	M 36	460 mm	78,00
Kat 2-2	M 36	520 mm	78,00
Kat 3-3	M 36	360 + 400 mm	85,00
Kat 3-3	M 36	460 + 520 mm	85,00

## Federsplinte



		einfach	doppelt
2 mm	10 Stück	1,00	1,50
3 mm	10 Stück	1,30	1,80
4 mm	10 Stück	2,00	2,40
5 mm	10 Stück	2,50	3,50
6 mm	10 Stück	3,90	5,90
7 mm	1 Stück	0,75	1,20
8 mm	1 Stück	1,10	1,50

## Splinte DIN 94



Größe	10 St. Pack
2 x 30	€ 1,00
3 x 30	€ 1,40
4 x 40	€ 1,90
4 x 50	€ 2,20
5 x 50	€ 3,40
5 x 80	€ 4,50
6 x 60	€ 4,50
7 x 70	€ 4,90
8 x 80	€ 6,00
10 x 80	€ 6,50



Sortiment im Kasten  
1,6-5/320 Stück € 16,50  
2-8/620 Stück € 21,50

## Spannhülsen

Sortiment im Kasten

3-10/160 Stück	€ 15,90
3-10/440 Stück	€ 69,50

## Klappsplinte



	10 Stück	Org. Rübzig
4 mm	€ 3,00	per Stück
6 mm	€ 3,00	7,5 mm € 4,50
8 mm	€ 3,00	9,5 mm € 4,50
9 mm	€ 3,00	10,5 mm € 4,50
10 mm	€ 3,00	11,5 mm € 4,50
11 mm	€ 3,00	







## Spannhülsen DIN 1481







Größe	10 St. Pack	per Stück
2 x 30	€ 0,60	
3 x 30	€ 0,80	
4 x 40	€ 1,20	
5 x 50	€ 1,80	
6 x 40	€ 2,00	
6 x 60	€ 2,50	
7 x 70	€ 4,00	
8 x 40	€ 2,80	
8 x 60	€ 4,00	
8 x 80	€ 5,00	
10 x 60	€ 5,00	€ 0,80
10 x 80	€ 6,50	€ 0,90
12 x 50	€ 12,00	€ 1,60
12 x 80	€ 15,00	€ 1,90
14 x 80	€ 20,00	€ 2,20
16 x 80	€ 23,00	€ 2,60





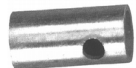

## Sicherungsringe- Sortiment im Kasten

10-20/220 Stück € 13,50  
8-42/374 Stück  
im Blechkasten € 54,90

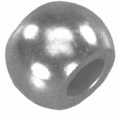
# Zubehör für Oberlenker / Unterlenker

Oberlenkerkugel		Oberlenkerkugel	Fanghaken	Anschweißauge	Reduzierhülse
					
<b>Nachbau</b>	<b>Original</b>	<b>Org. Walterscheid mit Nut</b>	<b>für Oberlenker</b>	<b>für Oberlenker</b>	<b>für Oberlenker</b>
Kat 2-2 € 3,30	€ 14,50	für besonders hohe Ansprüche	zum anschweißen	Kat 1 / 19 mm € 7,50	
Kat 3-2 € 4,80	€ 17,80	Kat 3-3 / 60-32mm / #202484	Kat 2 € 89,00	Kat 2 / 25 mm € 13,90	Kat 2-1 € 1,70
Kat 3-3 € 6,30	€ 17,80	€ 54,50	Kat 3 € 107,00	Kat 3 / 32 mm € 22,90	Kat 3-2 € 2,50

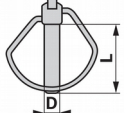
Oberlenker - Bolzen				Unterlenker - Bolzen		Reduzierhülse	
							
<b>mit Griff</b>	<b>gerade mit Bund</b>	<b>Stufenbolzen</b>	<b>Stufenbolzen</b>	<b>mit Griff</b>	<b>mit Gewinde</b>	<b>für Unterlenker</b>	<b>mit Loch</b>
Kat 1 € 4,50	Kat 1 € 2,90	gerade	gebogen	Kat 1 € 5,90	Kat 1 € 3,90	Kat 2-1 € 1,70	Kat 2-1 € 2,15
Kat 2 € 5,90	Kat 2 € 3,90	Kat 2-1 € 3,50	Kat 2-1 € 15,90	Kat 2 € 8,50	Kat 2 € 5,50	Kat 3-2 € 2,50	Kat 3-2 € 3,80
Kat 3 € 9,50	Kat 3 € 6,50	Kat 3-2 € 8,90	Kat 3-2 € 15,90	Kat 3 € 14,50	Kat 3-2 € 15,90		

Unterlenkerkugel		Fangtaschen		Klemmprofil	Klappsplinte für Fangtaschen	
						
<b>Nachbau</b>	<b>Original</b>	<b>Original mit Nut</b>	<b>Nachbau</b>	<b>Original</b>	<b>Nachbau mit Kette</b>	<b>Org. mit Kette</b>
		für hohe Belastung		zum Schrauben	11mm Kat 2 € 2,90	11mm Kat 2 € 9,50
Kat 2-2 € 3,20	€ 15,90	#202332	Kat 2-2 € 7,90	€ 28,90		16mm Kat 3 € 17,50
Kat 3-2 € 5,90	€ 18,90	Kat 3-3	Kat 3-2 € 9,50	€ 39,90	<b>Nachbau ohne Kette</b>	<b>Org. Walterscheid</b>
Kat 3-3 € 5,90	€ 19,90	€ 48,50	Kat 3-3 € 11,50	€ 43,90	11mm Kat 2 € 1,70	
Kat 4-3	€ 49,90				16mm Kat 3 € 3,80	

Schnellkuppler - Fanghaken		Distanzfeder	Ackerschienen	Anhängebolzen	Anschweißauge
					
<b>1 Satz = 2 Stück</b>	<b>1 Satz = 2 Stück</b>			<b>3,5 to mit Zulassung</b>	<b>für Unterlenker</b>
CBM	WALTERSCHEID				
Kat 2 - bis 80 PS € 229,00	<b>Original Walterscheid</b>	<b>für Unterlenker</b>	<b>Kat. 2</b>	<b>für Ackerschienen</b>	Kat 1 € 8,90
Kat 2 - ab 80 PS € 239,00	Kat 2 € 309,00	verstellbar	780 x 60 mm € 65,00	mit Gewinde M22	Kat 2 € 12,90
Kat 3 € 249,00	Kat 3 € 389,00	€ 21,50	945 x 60 mm € 75,00	€ 16,90	Kat 2+1 € 18,90
					Kat 3 € 27,50

Spanngurte			
			
<b>Länge</b>	<b>Breite</b>	<b>Zugkraft</b>	<b>€</b>
5 mtr.	25 mm	800 kg	3,50
6 mtr.	25 mm	1500 kg	6,20
6 mtr.	35 mm	2000 kg	7,50
8 mtr.	50 mm	4000 kg	10,90
8 mtr.	50 mm	5000 kg	14,50
10 mtr.	50 mm	4000 kg	13,90
10 mtr.	50 mm	5000 kg	16,50
15 mtr.	50 mm	4000 kg	18,90

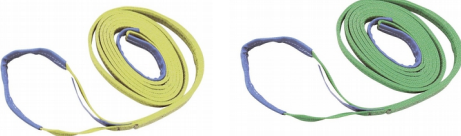
Hehebänder				
				
<b>Länge</b>	<b>Breite</b>	<b>Farbe</b>	<b>Zugkraft</b>	<b>€</b>
2 mtr.	30 mm	violett	1000 kg	5,20
4 mtr.	35 mm	violett	1000 kg	7,50
2 mtr.	60 mm	grün	2000 kg	7,50
4 mtr.	60 mm	grün	2000 kg	11,90
6 mtr.	60 mm	grün	2000 kg	18,90
2 mtr.	90 mm	gelb	3000 kg	12,50
4 mtr.	90 mm	gelb	3000 kg	20,50
6 mtr.	90 mm	gelb	3000 kg	25,90
4 mtr.	120 mm	grau	4000 kg	26,90

Rundschlingen				
				
<b>Länge</b>	<b>Umfang</b>	<b>Farbe</b>	<b>Zugkraft</b>	<b>€</b>
1,0 mtr.	2 mtr.	violett	1000 kg	3,90
1,5 mtr.	3 mtr.	violett	1000 kg	5,50
2,0 mtr.	4 mtr.	violett	1000 kg	6,50
3,0 mtr.	6 mtr.	violett	1000 kg	7,90
4,0 mtr.	8 mtr.	violett	1000 kg	10,90
1,5 mtr.	3 mtr.	grün	2000 kg	6,50
2,0 mtr.	4 mtr.	grün	2000 kg	8,50
3,0 mtr.	6 mtr.	grün	2000 kg	11,50
4,0 mtr.	8 mtr.	grün	2000 kg	15,90
6,0 mtr.	12 mtr.	grün	2000 kg	19,90
1,5 mtr.	3 mtr.	gelb	3000 kg	9,90
2,0 mtr.	4 mtr.	gelb	3000 kg	11,50
3,0 mtr.	6 mtr.	gelb	3000 kg	14,50
4,0 mtr.	8 mtr.	gelb	3000 kg	20,50
6,0 mtr.	12 mtr.	gelb	3000 kg	20,50
1,5 mtr.	3 mtr.	grau	4000 kg	12,50
2,0 mtr.	4 mtr.	grau	4000 kg	16,50
3,0 mtr.	6 mtr.	grau	4000 kg	18,50
4,0 mtr.	8 mtr.	grau	4000 kg	22,90
6,0 mtr.	12 mtr.	grau	4000 kg	24,50

Langhebel-Ratschenzug			
			
<b>Länge</b>	<b>Breite</b>	<b>Zugkraft</b>	<b>€</b>
8 mtr.	50 mm	5000 kg	19,90
10 mtr.	50 mm	5000 kg	20,50

Abschleppschlinge				
				
<b>Länge</b>	<b>Art. Nr.</b>	<b>Farbe</b>	<b>Zugkraft</b>	<b>€</b>
4 mtr.	71546	rot	35 to	39,90
6 mtr.	71547	rot	35 to	45,90
10 mtr.	71548	rot	35 to	72,90
6 mtr.	71549	blau	56 to	89,90

## Schleppersitze

Luftgederte Schleppersitze Grammer			
MAXIMO	Ausführung	Einbauhöhe	€
<b>Comfort</b> ohne Kopfstütze Stoff schwarz	Mechan. Bandscheibenstütze Horizontalfederung, kpl. mit Armlehnen (höhenstellbar) manuelle Gewichtseinstellung	240 mm	<b>995,00</b>
<b>Comfort Plus</b> Stoff	autom. Gewichtseinstellung Längs-Horizontalfederung autom. Positierungssystem integrierte Rückenverlängerung	265 mm	<b>1340,00</b>
<b>Professional</b> mit Kopfstütze	Niederfrequenzfederung, Sitztiefe/-neigung verstellbar Drehsteller 20° autom. Gewichtseinstellung	265 mm	<b>1670,00</b>
<b>Dynamic</b> mit Kopfstütze Bild #1	Sitzheizung, Klimasystem, aktive Bandscheibenstütze Seiten - Horizontalfederung	265 mm	<b>2190,00</b>
Schleppersitz mit Scherenfederung ital. Ausführung			
<b>Stoffbezug</b> Bild #2	mit Längsverstellung Armlehnen und Kopfstütze	260 mm	<b>399,00</b>
Schleppersitze mit Zugfederung und Längsverstellung			
gerade oder schräge Konsole Federweg 120mm / bis 120 kg			<b>109,00</b>
runde Rückenlehne mit Armlehnen pass. f. John Deere			<b>109,00</b>
schräge Konsole passend für Deutz klappbare Sitzfläche			<b>225,00</b>
Staplersitz Federweg 40mm			<b>159,00</b>
Schleppersitzkissen Lehne 20 cm			<b>31,90</b>
Schleppersitzkissen Lehne 30 cm			<b>34,50</b>



## Außenspiegel für Schlepper

	Glas	gerade	gewölbt
Außenspiegel 185x130 mm		8,90	
Außenspiegel 260x160 mm		13,90	
Außenspiegel 200x130 mm		11,40	20,90
Außenspiegel 240x130 mm		15,90	23,90
Außenspiegel 250x170 mm		19,90	25,90
Außenspiegel 320x180 mm		24,50	31,90
Außenspiegel 420x220 mm			31,50
Außenspiegel 420x220 mm mit totem Winkel-Blick 2-tlg.		52,90	
Traktorspiegel unzerbrechlich			
245x162 / Rohr 10-20 mm		36,50	
275x185 / Rohr 10-20 mm		39,90	
390x190 / Rohr 16-28 mm		51,50	
<b>passend für:</b>			<b>Ersatz-</b>
<b>Case XL &amp; XLA</b>			<b>glas</b>
240x150 mm #54179		29,50	
<b>Case CX/MX</b>			
320x230 mm Rundrohr CS		37,50	17,90
<b>Case Maxxum</b>			
314x228 mm / 14-22mm		38,50	24,50
<b>Claas / Deutz</b>			
310x220 mm / 16-18mm		49,90	31,90
<b>Fendt</b>			
250x140 mm #39700		23,50	
370x180 mm / 14-20mm		29,90	17,90
314x228 mm / 14-22mm		38,50	19,90
<b>Fiat/MF/Same</b>			
230x170 mm / 16-20mm		15,90	
<b>John Deere</b>			
295x215 mm / 18-24mm		39,50	13,90
<b>Spiegelhalter ausziehbar</b>			<b>€</b>
400-620 mm für Rohr 15 mm Ø			19,90
350-600 mm für Rohr 20 mm Ø			89,50

Anhängelbolzen			
Länge	mit Zugsicherung		geb. Hebel
	gerade		
350 mm	27,90		25,90
500 mm	29,50		29,50
650 mm	39,50		39,50
mit Kippsicherung			
350 mm	24,90	IHC / John Deere	

## Haubenhalter

65 lg.	€ 1,40	€ 1,90	mit Blechteilen
120 lg.	€ 1,90	€ 3,20	mit Blechteilen
150 lg.	€ 3,80	€ 4,70	mit Blechteilen

## Gasdruckdämpfer passend für:

	Frontscheibe	Heckscheibe	Tür	Dachluke
Case 744 - 1055	Org. 3232760R2 150 N / 400 mm € 33,50	Org. 3225465R2 215 N / 500 mm € 37,50	Org. 1284622C1 150 N / 240 mm € 21,50	Org. 3221572R1 180 N / 245 mm € 21,50
Case XL 744 - 1455	Org. 3232760R2 150 N / 400 mm € 33,50	Org. 3234163R1 180 N / 550 mm € 28,50	Org. 3232937R1 350 N / 280 mm € 34,90	Org. 3399422R3 160 N / 225 mm € 22,50
Deutz Serie DX	Org. 04357777 220 N / 500 mm € 38,50	Org. 04357777 220 N / 500 mm € 38,50	Org. 04373763 140 N / 600 mm € 37,90	Org. 04316669 200 N / 255 mm € 23,50
Fendt alte Ausführung	X800420489000 250 N / 603 mm € 24,90	X800420489000 250 N / 603 mm € 24,90	X800420491000 100 N / 501 mm € 25,50	X80042046000 120 N / 225 mm € 17,90
Fendt neue Ausführung	H205810040030 150 N / 505 mm € 29,50	H205810040030 150 N / 505 mm € 29,50	H816810030500 250 N / 325 mm € 25,90	H816810020100 120 N / 220 mm € 27,50
Fritzmeier	Org. 128685 / 1300 N / 220mm € 47,50			
John Deere Serie 6000 6310/6320	Org. AL 78987 170 N / 500 mm € 33,50	Org. AL 114803 130 N / 500 mm € 29,50	Org. AL 110629 250 N / 245 mm € 24,90	Org. AL 82634 220 N / 520 mm € 25,90

bei Bestellung bitte Schleppertyp und Länge oder Org. Ersatzteilnummer angeben !

## Kotflügel für Traktoren

Art.#	Breite mm	Länge mm	Bereifung	Gummi Dunloflex
E 2100	185	700	4.00/6.00-16	€ 26,80
E 2300	230	800	4.00/7.50-16	€ 29,90
E 2400	240	920	7.50-20, 9-20	€ 32,50
E 2500	310	1070	11.2-24+28	€ 41,50
E 2600	265	1000		€ 40,50
E 2700	350	1090	12.4+13.6-24	€ 44,90
E 2800	355	1245	12.4-28+32	€ 50,90
E 2900	410	1400	360/70 R28	€ 61,90
E 3000	410	1250		€ 63,90
E 3100	470	1300	16.9-24/26	€ 67,50
E 3400	520	1550		€ 84,50
E 3500	440	1400		€ 80,90
E 3800	620	1585		€ 89,50



Druckluftkupplung	Schlepper	Anhänger
rot Vorrat M 16x1,5	#92210	#91300
rot Vorrat M 22x1,5	#92010	#91200
gelb Bremse M16x1,5	#92110	#91100
gelb Bremse M22x1,5	#91910	#91000
	<b>€ 8,70</b>	<b>€ 5,70</b>
	Dichtung lose	€ 0,65
	Staubkappe rot/gelb	€ 1,70

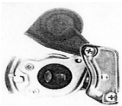

## Reifenfüller für Druckluftanlage

mit Manometer 8 mtr. € 64,50	Adapter lose #2015 € 19,50
---------------------------------	-------------------------------



## Fix-Lenker

Org. Agropa	€	19,50
Agropa / Kugellager	€	25,90



## Zapfwellen-Wasserpumpe

mit 3 mtr. Saugschlauch und 7 mtr. Druckschlauch

ML 20 € 225,00

600 U ca. 180 ltr/min

300 U ca. 150 ltr/min

Höchstdruck ca. 25 bar

Reparatursatz f. ML 20 € 55,90

Reparatursatz f. ML 300 € 69,90

**Zapfwellen-Wasserpumpe 400ltr./min ML 300**

ohne Saug- und Druckschlauch € 299,00



## Druckluftbremsschlauch

Gummischlauch	11x3,5mm	p/mtr.	3,20
Gummischlauch	13x6,0mm	p/mtr.	4,60
Schlauchsellen	11x3,5mm		1,70
Schlauchsellen	13x6,0mm		1,30
Schlauchstutzen	11 mm	M16x1,5	3,50
Schlauchstutzen	11 mm	M22x1,5	3,90
Schlauchstutzen	13 mm	M16x1,5	3,90
Schlauchstutzen	13 mm	M22x1,5	3,20



### Handhebelfettresse



Pressol o. Füllnippel (Plastikschlauch) € 15,90  
 Hallbauer Fettresse 1a mit Schlauch € 29,90  
 Mato **Industriepresse** mit Schlauch € 37,90  
 Schlauch 300 mm lose Gummi Ia € 9,20  
 Schlauch 500 mm lose Gummi Ia € 15,50  
 Füllnippel für Fettresse € 1,80  
 Hydr. Mundstück 4 Backen Mato € 3,10  
 Mundstück mit Rückschlagventil Mato € 8,20  
 Halter für Fettresse zum anschrauben € 10,90  
 Halter für Fettresse mit Magnet € 17,90  
 Mato Einhandfettresse m/Schlauch € 51,50

### Fettresse für Schraubkartuschen



€ 49,50

### Fettkupplung



(1) € 27,90  
 (2) € 42,50  
 (1) G-Kupplung  
 (2) Lock-ON

### Fettfüllgeräte



15 kg Eimer 240 - 270 Ø € 129,00  
 25 kg Eimer 310 - 335 Ø € 149,00

### Fetteimer Kajo







15 kg Mehrzweckfett € 109,00  
 15 kg Langzeitfett € 129,00  
 15 kg Fett mit MoS<sup>2</sup> € 124,00  
 1 kg Fließfett Tube € 8,90  
 5 kg Fließfett € 37,50  
 15 kg Fließfett € 99,00  
 25 kg Mehrzweckfett € 174,00  
 25 kg Langzeitfett € 209,00  
 25 kg Fett mit MoS<sup>2</sup> € 204,00

### Fett-Kartuschen Kajo



€ ab 24 St.  
 Standard 400 gr. 3,90 3,70  
 Langzeitfett 400 gr. 4,70 4,40  
 Graphitfett 400 gr. 4,40 4,10  
 mit MoS<sup>2</sup> 400 gr. 4,60 4,30  
**Schraubkartusche ab 20 St.**  
 Langzeitfett 500 gr. 6,20 5,90  
 TOP 2050V 500 gr. 6,80 6,50

### Trichter

Standard	flexibles Rohr	Winkelrohr	Sortiment
			
Org. Pressol € 6,90	Org. Pressol € 13,50	Org. Pressol € 15,50	70/160/240 Ø € 15,50

### Getriebeölpumpe Hydrauliköl



Pressol 16 ltr. Inhalt fahrbar € 94,50  
 HLP 46 20 ltr. € 74,90

### Schmier-nippel



10 Stück Pack.	gerade	45 °	90 °
M 6 x 1	€ 2,00	4,70	4,50
M 8 x 1	€ 2,20	4,70	4,70
M10 x 1	€ 2,50	4,90	4,90

### Meßbecher Ölspritzkannen

Feineinteilung	Deckel und Rohr	Pressol	Pressol	Pressol	Pressol
					
2 ltr. € 10,90	1 ltr. € 9,50	250 ml Plastik € 4,90	250 ml Blech € 11,90	300 ml Plastik € 22,50	300 ml Metall € 29,90
3 ltr. € 17,90	3 ltr. € 12,90				
5 ltr. € 24,50	5 ltr. € 15,90				

### Schmiernippel-Sortiment



Gewinde M6 - M10  
 110 Stück € 24,90

### Kurbelpumpe



**18 ltr. / min**  
 mit Faßverschraubung höhenverstellbar für Öle und Diesel  
 mit Auslauf Gußgehäuse € 56,90  
 mit Schlauch Alugehäuse € 79,50

### Ölauffangwanne



für 2 x 200 ltr. Behälter 1200x800x380 mm € 359,00  
 4 x 200 ltr. Behälter 1200x1200x340 mm € 525,00

### Ölbindemittel



40 ltr. Sack € 22,90

### Bohrkraft - Spiralbohrer

DIN 388 zylindrisch HSS Cobalt			DIN 345 MK2 - MK4			abgedr. Schaft	
2 Ø	€ 0,25	0,60	14 Ø	€ 7,50	14 Ø	8,50	
3 Ø	€ 0,30	1,00	16 Ø	€ 8,50	16 Ø	9,90	
4 Ø	€ 0,45	1,20	18 Ø	€ 9,50	18 Ø	12,20	
5 Ø	€ 0,50	1,70	20 Ø	€ 12,90	20 Ø	14,90	
6 Ø	€ 0,60	2,20	22 Ø	€ 14,90	22 Ø	21,90	
7 Ø	€ 0,70	2,90	24 Ø	€ 19,50	24 Ø	27,90	
8 Ø	€ 1,00	4,40	28 Ø	€ 26,50			
10 Ø	€ 1,60	6,60	30 Ø	€ 35,50			
12 Ø	€ 2,20	9,90	32 Ø	€ 42,60			
14 Ø	€ 3,30	15,30	36 Ø	€ 57,50			
16 Ø	€ 6,90						

weitere Spiralbohrer auch in 0,5 Zwischengrößen sofort ab Lager lieferbar

### Bohrerkassetten Bohrkraft

HSS 1-10	20 St. rollgewalzt	€ 12,50
HSS 1-13	25 St. rollgewalzt	€ 24,50
HSS 1-10	20 St. geschliffene Ausf.	€ 17,90
HSS 1-13	25 St. geschliffene Ausf.	€ 36,50
1-10	20 St. Titan beschichtet	€ 25,50
1-13	25 St. Titan beschichtet	€ 45,50
1-10	20 St. Cobalt	€ 33,90
1-13	25 St. Cobalt	€ 72,50
3-10	8 St. Betonbohrer	€ 12,50
5-12	7 St. SDS Bohrer	€ 14,90

### HSS-Gewindeschneidkasten Fabrikat Bieler



M 3 - M 12 Kunststoffbox € 89,00  
 M 3 - M 20 Holzkassette € 399,00

Gewindebohrer DIN 352 HSSG	Schneideisen DIN 223		
			
Satz = 3 teilig			
M 6	7,20	M 6	5,50
M 8	8,90	M 8	5,90
M 10	10,90	M 10	7,50
M 12	14,50	M 12	9,90
M 16	22,50	M 16	14,90
M 20	33,50	M 20	16,50

**Gewindebohrer für Schmiernippel (Satz = 2 Stück)**  
 M 6 x 1 € 6,50  
 M 8 x 1 € 27,50  
 M10 x 1 € 27,50

### Gummi-O-Ring Sortiment



Metrisch 3-45 400 St. € 19,90  
 Zoll 2,9-43,8 380 St. € 28,50

### Kupfering-Sortiment



120 St. von 8-22 mm € 27,50  
 80 St. von 14-32 mm € 27,50  
 240 St. von 6-33 mm € 52,80  
 540 St. von 6-33 mm € 99,00

## Steckschlüsselkasten



1/4"+3/8"+1/2" BGS  
171 teilig € 115,00

## Elora - Elofort Werkzeug "Made in Germany"

### Umschaltknarre



Elofort 1/4" 145 mm lg. € 20,90  
Elora 3/8" 200 mm lg. € 61,50  
Elofort 1/2" 250 mm lg. € 33,50  
Elora 1/2" Feinzahn 270lg. € 69,90  
Elora 1/2" m. Gelenk 430lg. € 99,90  
Elora 3/4" Umschaltknarre € 149,90



### Steckschlüsselkasten

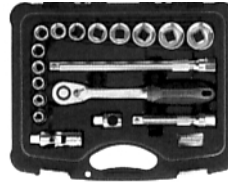

**Elofort**  
1/2" 26 tlg. 8-32 mm € 99,50  
3/8" 49 tlg. 6-22 mm € 87,50  
1/4" 46 tlg. 4-14 mm € 69,90



### Nußkasten 3/4"



22-50 mm Elofort € 229,00

### Kreuzschlüssel



19/22/24/27 mm 600 lg. € 74,40  
24/27/32/3/4" 4kt. 750 lg. € 104,90  
dto. verst. Mittelstück € 194,00  
für PKW 17/19/22/1/2" € 14,60

### Flachmeißel f. Metall



200 mm	€ 10,20	300 mm	€ 14,80
250 mm	€ 12,40	400 mm	€ 19,90

### Splintentreiber-Satz

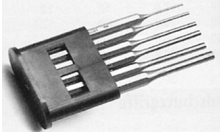

6 Stück 3-8 mm € 24,40  
lose 2-10 mm je € 4,20  
Durchtreibersatz € 20,70

### Meißel- und Durchtreibersatz

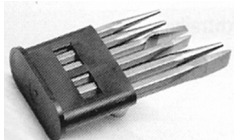

mit Körner 6-teilig € 31,40

### Gabelschlüssel mit Ringratsche

10 mm	€ 16,50
13 mm	€ 18,60
17 mm	€ 23,40
19 mm	€ 25,40
22 mm	€ 40,60
24 mm	€ 45,70
27 mm	€ 54,70



### Doppel-Gabelschlüssel



10/13	€ 2,90	22/24	€ 8,20
13/17	€ 4,20	24/27	€ 9,30
16/18	€ 8,50	30/32	€ 12,20
17/19	€ 4,90	32/36	€ 31,20
18/21	€ 10,60	36/41	€ 41,70
19/22	€ 6,20	41/46	€ 56,50

### Doppel-Ringschlüssel



10/13	€ 12,40	22/24	€ 21,60
13/17	€ 14,20	24/27	€ 23,90
16/18	€ 15,90	30/32	€ 29,90
17/19	€ 15,90	32/36	€ 46,90
18/21	€ 19,40	36/41	€ 58,40
19/22	€ 19,40	41/46	€ 75,50

### Gabel-Ringschlüssel Elora extra lange Ausführung



10 mm	€ 8,70	22 mm	€ 19,50
13 mm	€ 10,20	24 mm	€ 24,20
14 mm	€ 11,40	27 mm	€ 27,90
16 mm	€ 12,90	30 mm	€ 34,70
17 mm	€ 14,20	32 mm	€ 36,20
18 mm	€ 15,70	36 mm	€ 53,90
19 mm	€ 16,70	41 mm	€ 79,90
21 mm	€ 18,60	46 mm	€ 109,90

### Gabelschlüssel mit Ringratsche

Satz 12 tlg. gekröpft  
Fabrikat BGS 8-19mm



€ 64,90

### Gabelschlüssel-Satz



8 tlg. 6-22	Elofort	€ 21,90
12 tlg. 6-32	Elofort	€ 59,50
8 tlg. 6-22	Import	€ 11,50
12 tlg. 6-32	Import	€ 27,90

### Doppel-Ringschlüssel-Satz



8 tlg. 6-22	Elofort	€ 29,90
12 tlg. 6-32	Elofort	€ 62,50
8 tlg. 6-22	Import	€ 19,80
12 tlg. 6-32	Import	€ 28,90

### Gabel-Ringschlüssel-Satz



10 tlg. 6-22	Elofort	€ 31,50
12 tlg. 6-32	Elofort	€ 69,90
extra lange Ausführung		
16 tlg. 6-32	Elora	€ 225,00
25 tlg. 6-32	Import	€ 52,50
Import in Rolltasche € 52,50		

### Steckschlüssel-Einsätze

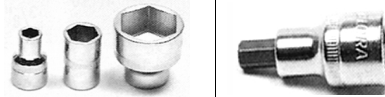

sechskant			Inbus	
SW	1/2"	3/4"	SW	1/2"
10 mm	6,90		4 mm	8,60
13 mm	6,90		5 mm	8,60
14 mm	6,90		6 mm	8,60
17 mm	7,60		7 mm	8,60
18 mm	7,60	13,20	8 mm	8,70
19 mm	7,60	13,20	10 mm	8,90
21 mm	7,60	13,20	12 mm	9,40
22 mm	7,60	13,40	14 mm	10,20
24 mm	9,60	13,60	17 mm	10,40
27 mm	11,50	14,20	19 mm	11,20
30 mm	11,50	15,20	22 mm	16,90
32 mm	11,50	15,70		
36 mm	19,20	21,70		
41 mm		27,20		

### Verlängerung



1/4"	50 lg.	€	4,20
1/4"	100 lg.	€	4,50
1/2"	75 lg.	€	11,20
1/2"	125 lg.	€	11,20
1/2"	250 lg.	€	11,90
3/4"	100 lg.	€	24,90
3/4"	200 lg.	€	29,40
3/4"	400 lg.	€	43,20

### Verbindungsstücke

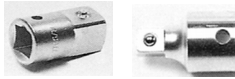

Reduzierung 3/4"-1/2"	19,90
Vergrößerung 1/2"-3/4"	12,50
Reduzierung 3/4"-1/2" für Schlagschrauber	34,40

### Montierhebel



400 lang € 21,60  
500 lang € 27,50  
600 lang € 36,60

### Schwerer Montierhebel



600 lang € 43,40

### Nietenkopfmacher Nietenzieher



5mm € 10,50  
6mm € 10,50

### Abzieher zweiarmig schwere Ausführung

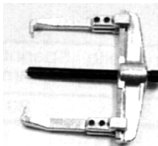

**Breite lg.**  
173/130 130x 90 € 88,50  
173/160 160x150 € 149,90  
173/200 200x150 € 159,90  
173/250 250x200 € 274,90  
173/350 350x200 € 299,90  
Polklemmenabzieher € 35,90

### Abzieher dreiarmig schwere Ausführung

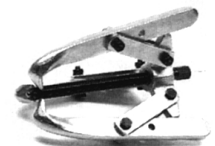

**Breite lg.**  
320/150 150x 80 € 88,90  
320/200 200x130 € 154,90  
177/300 300x240 € 214,90  
177/400 400x400 € 274,90

## Wasserpumpenzangen



240 lg. Fabrikat BGS € 8,30  
 300 lg. Fabrikat BGS € 16,70  
 240 lg. Rillenführung € 19,90  
 Fabrikat Knipex

## Eck-Rohrzangen

Elora gerade Form



1" € 48,50 2" € 94,90  
 1 1/2" € 60,90 3" € 154,00

## Eck-Rohrzangen

Elora System 3-Punkt



1" € 24,90 2" € 55,90  
 1 1/2" € 36,50 3" € 114,90

## Schlosserhammer

Fabr. BGS mit TÜV/GS



300 gr. € 5,40  
 400 gr. € 5,95  
 500 gr. € 6,95  
 800 gr. € 9,20  
 1000 gr. € 11,60  
 1500 gr. € 11,90  
 2000 gr. € 17,50

## Innen- Außentorx Satz



1/2" 19-teilig im Kasten € 47,50  
 TX20 - TX70 + TXE10 - TXE24

1/2" 11-teilig im Kasten € 45,90  
 Inbuß 5mm-22mm

## Bit-Box



Wera 30 Bits	
Set mit PH,PZ und Torx	22,90
Set mit 30 x Torx	22,90

Bit-Box Bohrkraft 31-teilig	€ 19,90
-----------------------------------	---------

## Satz Torx-Schlüssel



TX9-TX40 Standard € 38,90  
 TX5-TX50 lange Ausf. € 52,90

## Satz Inbusschlüssel mit Kugelkopf

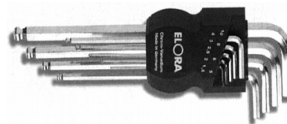

lange Ausführung € 22,50



**Nageleisen** 600 lg. € 15,90  
**Nageleisen** 800 lg. € 18,40

**Brechstange** 1500 lg. € 53,90

## Werkzeugkoffer



5-teilig 530x200x200 mm € 55,50

## Zange für Sicherungsringe



f. Ringe	innen		außen	
	gerade	gekröpft	gerade	gekröpft
8- 25	22,20	23,40	24,20	25,80
19- 60	23,20	24,20	25,50	26,60
40-100	30,90	32,70	31,90	33,90
85-165	48,40	49,90	49,90	50,90
	#473J	#473J	#474A	474A



**Präzisions-Taschenschieblehre**  
 € 33,40



**Gummihammer**  
 Kopf 70 Ø € 12,20

**ELORA Lattenhammer**  
 € 26,50

**Vorschlaghammer**  
 3 kg € 32,90  
 5 kg € 39,90  
 8 kg € 69,00  
**Fäustel 2 kg**  
 mit Fiberglasstiel € 16,50  
 Fäustelstiel 2000 gr. € 3,20

## Schraubenziehersatz



BGS Kunststoffgriff  
 Sechskant-  
 klinge

12 Stück im Koffer € 39,90

## Elofort

5 Stück Set Sechskantklinge 49,90

7 Stück Set runde Klinge 35,50



## Schraubenzieher Holzheft



Elora

Schneide	Klingen-Länge	€
0,6x3,5 / SZ0	75 mm	6,20
0,8x4,5 / SZ1	90 mm	6,40
1,0x5,5 / SZ2	100 mm	6,60
1,0x7,0 / SZ3	125 mm	8,70
1,2x8,0 / SZ4	150 mm	10,90
1,6x10,0 / SZ5	175 mm	12,40
2,0x12,0 / SZ6	200 mm	15,90
Kreuz PH1	85 mm	6,80
Kreuz PH2	100 mm	9,10
Kreuz PH3	150 mm	11,40

## Schruppscheibe



mm	€	ab 5 St.
115x6	1,70	1,50
125x6	1,90	1,70
178x6	2,60	2,30
178x8	3,30	3,00
230x6	4,40	4,00
230x8	5,20	4,90

## Trennscheiben



Metall oder Stein		ToroFlex		Pack	
mm	€	mm	€	mm	€
115x2,5	1,00	115x2,5	1,00	25 St.	0,90
125x2,5	1,10	125x2,5	1,10		1,00
178x3,0	1,30	178x3,0	1,30		1,20
230x3,0	1,60	230x3,0	1,60		1,50

## extra dünn



„INOX“		Packung	
mm	€	mm	€
115x1,0	10 Stück / 10,90		
125x1,0	10 Stück / 11,50		
125x1,0 Aktion	50 Stück / 36,00		
178x1,6	10 Stück / 19,50		
230x1,9	10 Stück / 26,90		
230x1,9 Aktion	25 Stück / 47,50		

## Fächerscheiben



mm	€
115 Ø K64	2,80
115 Ø K60	2,80
125 Ø K40	3,10
125 Ø K60	3,10
178 Ø Metall	6,90
ab 10 Stück 10% Mengenrabatt	

## Diamanttrennscheiben für Winkelschleifer

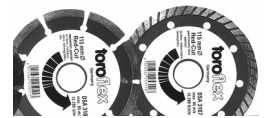

125 Ø für Beton Edelco	€ 8,90
178 Ø für Beton Toroflex	€ 35,80
230 Ø für Beton Edelco	€ 29,50
230 Ø für Beton Toroflex	€ 43,90

## Drahtbürste gewellter Draht

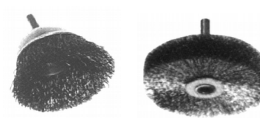

Topfbürste 50 Ø	€ 2,40
Topfbürste 70 Ø	€ 3,20
Runddrahtbürste 70 Ø	€ 2,80
Runddrahtbürste 100 Ø	€ 3,50

## Scheibenbürste gezopfter Draht



115/22 Ø	€ 12,50
125/22 Ø	€ 14,90
178/22 Ø	€ 20,90

## Topfbürsten Gewinde M14



60 Ø gewellt	€ 5,90
60 Ø gezopft	€ 7,20
80 Ø gezopft	€ 10,90
100 Ø gezopft	€ 17,50

## Drahtbürste



3 reihig	2,20
4 reihig	2,70
5 reihig	2,90
6 reihig	3,20

## Reinigungsvlies



Grobreinigungsvlies für Winkelschleifer	€
115mm Ø	10,90
125mm Ø	12,50

## Schmirgelleinen

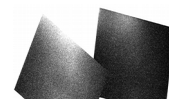

blau 280x230 mm	€
K40,K60,K80,K100	
K150,K180,K220	
per Bogen € 0,70	

## Schleifkörper



konisch	4,20
zylindrisch	3,50



# Werkzeug „Made in Germany“



<b>Cobra ES extra schlank</b>  Schnelleinstellung per Knopfdruck 250 lg. € 33,20	<b>Schraubzange</b>  Schlüsselweite 10-32 mm Schnelleinstellung per Knopfdruck 10 - 32 mm € 34,50	<b>Cobra XL</b>  Rohr- und Wasserpumpenzange bis 3" 26 Verstellungen / 400 mm lg. 400 lg. € 73,90	<b>Cobra XXL</b>  Rohr- u. Wasserpumpenzange bis 4,5" 20 Verstellungen / 560 mm lg. 600 lg. € 124,00
---	---	---	--

<b>Wasserpumpenzange Cobra</b>  Schnelleinstellung per Knopfdruck 125 lg. € 26,50   250 lg. € 30,20 180 lg. € 28,40   300 lg. € 41,90	<b>Bolzenschneider CoBolt</b> kompakte Bauform 200 mm lang  bis 5mm Drahtstärke gerade Backen € 44,50 gekröpfte Backen € 61,90	<b>Bolzenschneider</b>  bis 9 mm / 610 lg. € 129,00 bis 11 mm / 760 lg. € 167,00 bis 13 mm / 910 lg. € 219,00	<b>Kraftseitenschneider</b>  200 lg. gekröpfte Ausführung € 35,20
---	---	---	---

<b>Kraftseitenschneider</b>  180 lg. gerade Ausführung € 26,50 200 lg. gerade Ausführung € 33,90 250 lg. gerade Ausführung € 40,90	<b>Kneifzange</b>  225 lg. € 19,40 250 lg. € 23,20	<b>Rabitzzange</b>  250 lg. € 16,70 280 lg. € 18,40 300 lg. € 21,80	<b>Monierzange</b>  Kopfbreite 25mm bis 4,5mm Drahtstärke 300 lg. € 27,60
--	---	---	---

<b>Gripzange</b>  250 lg. € 23,20	<b>Kabelschuhzange</b>  € 26,40	<b>Spitzzange</b>  gerade gekröpft 200 lg. € 31,50	<b>Kombizange</b>  200 lg. € 22,90 250 lg. € 28,90	<b>Zangenschlüssel</b>  verstellbar per Knopfdruck bis 46 mm / 250 lg. € 64,40
---	---------------------------------------	--	---	---

<b>Sicherungsringzangen</b> 19 - 60mm / Set 4 Zangen  für Innenringe und Außenringe gerade und gekröpfte Zangen € 87,20	<b>Schraubstock Durlach Magnat</b>  16 kg Breite 140 mm Öffnung 200 mm € 248,00	 26 kg Breite 160 mm Öffnung 228 mm € 325,00
--	--	--

Lagerkasten, stapelbar				
	Länge	Breite	Höhe	€
Gr. 0	110 mm	100 mm	55 mm	0,80
Gr. 1	170 mm	110 mm	75 mm	1,20
Gr. 2	250 mm	160 mm	130 mm	2,30
Gr. 3	350 mm	220 mm	170 mm	5,50
Gr. 4	500 mm	330 mm	190 mm	10,90

Digitale Hängewaage		
bis 50 kg Teilung 20 gr. 	2 - 300 kg Teilung 100 gr. 	50 - 1000 kg Teilung 500 gr. 
DigiScale 50 € 21,50	DigiScale 300 € 139,00	DigiScale 1000 € 239,00

Taschenlampe	LED-Handleuchte mit Akku	LED-Leuchte
inkl. USB-C Aufladekabel; 5 Leuchtstufen; stufenlose Fokussfunktion 	 BGS	mit Batterie Haken + Magnet 
LED ProFire 1800 1800 Lumen € 19,90	USB Ladekabel € 24,90	Hedi USB + 12Volt € 41,90
		WorkFire 20 cm 200 Lumen € 7,40

Zeiger-Schnellwaage	
10 kg Teilstrich 50 gr. € 16,90	
25 kg Teilstrich 100 gr. € 16,90	
50 kg Teilstrich 200 gr. € 16,90	
100 kg Teilstrich 500 gr. € 16,90	

Baueimer	
Eimer 12 ltr. schwarz	€ 1,70
Eimer 20 ltr. mit Kreuzboden	€ 2,95
Eimer 12 ltr. grün extrastark	€ 5,90
Kartoffelkorb 15 kg grün Fabr. Jopa	€ 5,95
Kartoffelkorb 25 kg grün Fabr. Jopa	€ 6,95

Mörtelkasten Jopa	
aus Hochdruckpolyethylen mit 4 Griffen	
<b>Inhalt eckig</b>	<b>€</b>
65 ltr. 74x42cm	5,95
90 ltr. 81x51cm	7,90
<b>rund</b>	<b>€</b>
630x33cm	5,95
700x35cm	7,25

Schraubzwingen Org. Bessey	
160 x 80 mm	€ 17,50
200 x 100 mm	€ 24,50
250 x 120 mm	€ 29,50
300 x 140 mm	€ 36,50
400 x 175 mm	€ 44,90
500 x 120 mm	€ 45,90
600 x 120 mm	€ 47,90
800 x 120 mm	€ 54,50
1000 x 120 mm	€ 59,90

Handseilwinde		
zum Ziehen und Versetzen von Lasten		
#37114	Seil 5mm	#37113
10 mtr. Seil		20 mtr. Seil
ohne Bremse		mit Bremse
bis 360 kg		bis 720 kg
€ 39,50		€ 62,90

Flaschenzug elektrisch		
230 Volt	300 kg	600 kg
Hubhöhe	ca. 11 mtr.	ca. 6 mtr.
€ 189,00		

**B**  
**H**

**6 mtr. nur Abholung**

max Türgewicht	B x H	2 mtr.	3 mtr.
#0 / 82100 90 kg	30x28	23,80	35,70
#1 / 82102 180 kg	40x35	34,00	51,00
#2 / 82104 400 kg	48x43	39,80	59,70
#3 / 82106 600 kg	65x60		109,00

**Rollapparat einpaarig**

kg	85050	16,90
50	85051	22,50
100	85052	27,90
150	85053	49,90

**Rollapparat doppelpaarig**

kg	85000	23,50
90	85002	32,50
200	85004	41,40
300	85010	79,90

**Wandmuffe**

	85170	7,80
	85171	8,80
	85172	11,90
	85173	21,90

**Doppel Wandmuffe**

	85167	15,90
	85165	23,50
	85164	33,50
	85166	58,00

**Deckenmuffe**

	85180	7,60
	85181	9,90
	85182	13,50
	85183	25,50

**Doppel-Deckenmuffe**

	85188	16,90
	85185	25,90
	85186	31,50
	85184	58,00

**Einfachrolle**

#	Preis	50 mm
#0	€ 14,90	
#1	zum	mit Platte
#2	einhängen	80 x 60 mm
#3	von Planen	€ 27,90

**Führungsrolle**

	85133	6,20
	85134 <td>6,20</td>	6,20
	85134 <td>11,90</td>	11,90

**Muffe höhenverstellbar**

	85190	7,90
	85191	9,90
	85192	14,90
	85193	28,90

**Einfach-Träger 75 mm lg.**

	85210	4,10
	85211	10,50
	85211	10,50
	85212	22,50

**Doppel-Träger 155 mm lg.**

	81301	6,90
	81354	16,50
	81354	16,50
	81379	35,90

**Anschraubplatte**

	81014	4,70
	81021	6,90
	81024	9,50
	81028	16,60

**Lasche**

	81013	7,20
	81019	10,50
	81022	11,90
	81025	26,50

**Verbinder**

#	85200	10,40
#1	85201	14,20
#2	85202	17,90
#3	85203	24,90

**Schienenstopper**

	85100	3,20
	85101	7,20
	85104	8,40
	85105	13,60

**Muschelgriff 200 x 90 mm**

	81201	13,20
--	-------	-------

**Laschen**

	verzinkt	Edelstahl
1/2"	0,40	1,00
3/4"	0,40	1,00
1"	0,60	1,60
1 1/4"	0,80	2,25
1 1/2"	0,80	2,25
2"	0,80	2,85

**Bügelsschrauben mit Muttern**

	verzinkt	Edelstahl
1/2"	0,70	1,70
3/4"	0,55	1,30
1" x 55	0,55	1,50
1" x 80	0,75	1,90
1 1/4"	0,60	1,50
1 1/2" M8	0,70	1,70
1 1/2" M10	1,40	3,50
2"	1,40	3,50
2 1/2" M10	1,55	3,80
3" M12	2,10	

**T-Schellen geteilt feuerverzinkt**

	Preis
3/4" x 3/4"	€ 2,90
1" x 1"	€ 3,60
1 1/4" x 1"	€ 3,90
1 1/2" x 1"	€ 4,40
1 1/4" x 1 1/4"	€ 4,80
1 1/2" x 1 1/2"	€ 4,90
1 1/2" x 1 1/2"	€ 6,40
2" x 1 1/2"	€ 9,50
2" x 2"	€ 11,20
1 1/2" x 2"	€ 9,30
2 1/2" x 2"	€ 12,50

**Lochbleche**

Größe	Preis
60x200x2 mm	1,20
80x200x2 mm	1,50
100x200x2 mm	1,90

**Ankernägel**

250 St. Pack.	Preis
4x40 mm	8,40
4x50 mm	9,90
4x60 mm	10,50

**S-Haken**

Ø	Preis
5 Ø	€ 0,25
6 Ø	€ 0,30
7 Ø	€ 0,35

**Winkelschelle feuerverzinkt**

	1 1/2"	€ 12,50
	2"	€ 14,90

**Kreuzschelle 3-teilig verzinkt**

	1 1/2"	€ 13,50
	2"	€ 14,90
	1 1/2" x 2"	€ 14,20

**Kreuzschelle 2-teilig verzinkt**

	1 1/2"	€ 9,50
	2"	€ 14,90

**Nackenrohrklammer verzinkt € 3,50**

	1 1/2" x 1 1/2"	2" x 2"
	1 1/2" x 2"	2" x 1 1/2"

**Winkelverbinder verzinkt**

ohne Rippe	Breite	Preis
60 x 60 mm	25 mm	0,45
60 x 60 mm	40 mm	0,65
60 x 60 mm	60 mm	0,65
105 x 105 mm	90 mm	1,70

mit Verstärkungsrippe	Breite	Preis
90 x 90 mm	65 mm	0,80
105 x 105 mm	90 mm	1,70

**Rohrschelle verzinkt**

	1"	€ 3,50
	1 1/2"	€ 3,60
	2"	€ 3,95
	2 1/2"	€ 4,90

**Stahlkupplung verzinkt**

	1 1/2"	€ 7,20
	2"	€ 10,60

**Sicherheitsüberfalle**

leicht	schwer
120x35x2,5 mm	175x55x4 mm
€ 4,20	€ 7,60

**Schlossriegel**

gerade	mit Stift
160 x 60 mm	160 x 65 mm
€ 6,50	€ 17,90

**Riegel mit Bolzen**

mit Bolzen
160 x 70 mm
€ 6,40

**Doppeltorüberwurf für Vorhangschloss geeignet**

Hebel 370x30x8 mm
€ 13,50

**Scharnier kätig**

50 x 50 mm
€ 1,30

**Scharnier breit**

40x60	€ 1,30
60x90	€ 2,20

**Kistenband franz. Form**

160 x 35 mm
€ 1,90

**Torrollen kpl. mit Band**

Ø	Länge	max Torgewicht	kpl. mit Band	Ersatzrolle
60	250 mm	60 kg	21,80	14,90
75	360 mm	80 kg	27,50	18,90
90	420 mm	100 kg	34,50	20,50
105	420 mm	140 kg	39,90	23,20
120	500 mm	200 kg	48,90	27,90
140	500 mm	300 kg	63,50	37,50
160	500 mm	350 kg	74,90	44,50

**Ladenbänder gelb verzinkt**

Länge	Abmessung	Preis	Kloben
500 mm	40x4,5 mm/13Ø	3,95	1,90
600 mm	40x4,5 mm/13Ø	4,90	1,90
700 mm	40x4,5 mm/13Ø	6,10	1,90
800 mm	45x5,5 mm/16Ø	8,90	2,90
1000 mm	60x7,0 mm/20Ø	28,50	7,90
1200 mm	60x7,0 mm/20Ø	31,50	7,90
1400 mm	60x7,0 mm/20Ø	36,50	7,90
1600 mm	60x7,0 mm/20Ø	46,50	7,90

**Sturmhaken**

Länge	Preis
300 mm	€ 10,50
500 mm	€ 12,20

**Kreuzgehänge gelb verzinkt schwere Ausführung**

Länge	Preis
400 mm	€ 5,60
500 mm	€ 5,95
600 mm	€ 6,90

Lackierpistole	Druckluftöl	Inline-Öler	Spiralschlauch	automatischer Schlauchaufroller	
<b>Fabrikat EWO</b> im Koffer € 98,00	Spezialöl für Druckluftwerkzeuge 1 ltr. € 14,20	für Schlagschrauber € 14,50	8mm x 6 mtr. kpl mit Kupplungen € 44,90	Kunststoffgehäuse 15mtr. 9 mm € 79,00 20mtr. 9 mm € 99,00	Metallgehäuse EWO 12mtr. 8 mm Schlauch € 169,00

Schlagschrauber – Nuß Elora Impact schwarz		Nußkasten für Schlagschrauber		Blaspistole	
17 mm 1/2 <sup>cc</sup> € 8,40		19 mm 3/4 <sup>cc</sup> € 22,90			
19 mm 1/2 <sup>cc</sup> € 8,60		22 mm 3/4 <sup>cc</sup> € 22,90			
22 mm 1/2 <sup>cc</sup> € 9,40		24 mm 3/4 <sup>cc</sup> € 24,60			
24 mm 1/2 <sup>cc</sup> € 9,70		27 mm 3/4 <sup>cc</sup> € 24,60			
27 mm 1/2 <sup>cc</sup> € 12,20		30 mm 3/4 <sup>cc</sup> € 24,60			
30 mm 1/2 <sup>cc</sup> € 13,90		32 mm 3/4 <sup>cc</sup> € 27,20			
32 mm 1/2 <sup>cc</sup> € 15,50		36 mm 3/4 <sup>cc</sup> € 28,40			
		41 mm 3/4 <sup>cc</sup> € 33,40			
		46 mm 3/4 <sup>cc</sup> € 37,90			
		lange Ausführung auf Anfrage	1/2 <sup>cc</sup> 10-24mm € 22,90	1/2 <sup>cc</sup> 10-24mm € 44,90	ohne Rohr € 4,50
		3/4 <sup>cc</sup> 26-38mm € 69,90	3/4 <sup>cc</sup> 26-38mm € 99,90	Rohr 500 lg. € 19,90	Rohr 800 lg. € 24,90

Reifenfüller	EWO	EWO geeicht	Ölsprühpistole	Blaspistole EWO	
					ohne Rohr € 19,90
ital. Ausf. € 13,90	mit Hebelstecker	Hebelstecker	<b>Fabrikat Ewo</b>		<b>Verlängerung für Blaspistole</b>
geeichte Ausf. € 43,90	Typ 356 € 62,90	€ 165,00	mit Kunststoffbehälter		Rohr 30 cm gerade € 11,90
		€ 179,00	€ 69,90		Rohr 45 cm gerade € 13,90
					Rohr 80 cm gerade € 19,90
					Rohr 45cm gebogen € 16,50
					Rohr 80 cm gebogen € 20,50

Verteiler	Verteilerblock für Wandbefestigung	Kupplung für Schlauch	Stecknippel für Schlauch	Kupplung mit Außengewinde	Stecknippel Außengewinde	Kupplung mit Innengewinde	Stecknippel Innengewinde	Hebel-Ventilstecker	Reifen-Füllnippel
2-fach € 24,50	3-fach	6 mm € 4,90	6 mm € 1,00	1/4 " € 4,50	1/4 " € 1,50	1/4 " € 4,20	1/4 " € 1,20	€ 3,20	€ 2,50
	1/2 Innengewinde	9 mm € 4,90	9 mm € 1,00	3/8 " € 4,50	3/8 " € 1,50	3/8 " € 4,20	3/8 " € 1,20		
3-fach € 29,50	€ 26,90	13 mm € 4,90	13 mm € 1,00	1/2 " € 4,50	1/2 " € 2,60	1/2 " € 4,20	1/2 " € 2,60		

### Kompressor Birkenstock 380 Volt

Made in Germany

Kesselvolumen	Ansaugleistung	Liefermenge	€
40 ltr. 10 bar	500 ltr.	350 ltr.	1390,00
90 ltr. 10 bar	500 ltr.	350 ltr.	1490,00
90 ltr. 10 bar	750 ltr.	580 ltr.	2250,00
90 ltr. 15 bar	750 ltr.	580 ltr.	2350,00

### Kompressor-Schlauch

	€
6 mm PVC-Gewebe	19,50
9 mm PVC-Gewebe	22,90
13 mm PVC-Gewebe	39,90
9 mm Nobelair-Soft	35,90
13 mm Nobelair-Soft	48,50

10 mtr. komplett mit Kupplungen

### Kompressor-Schlauch

	€
6 mm PVC-Gewebe	1,60
9 mm PVC-Gewebe	1,90
13 mm PVC-Gewebe	2,90
9 mm Nobelair-Soft	2,80
13 mm Nobelair-Soft	3,95

Rollenware / Preis per mtr.

### Luftrad Mefro mit Stahlfelge und Kugellager

200x50 Bohrung 20Ø	€ 33,90
210x65 Bohrung 20Ø	€ 54,50
260x85 Bohrung 20Ø	€ 29,50
400x100 Bohrung 10Ø	€ 39,90
400x100 Bohrung 25Ø	€ 40,50

stabile Ausführung mit Reifen 4 PR

### Luftrad mit Felge

260x 85 Bohr. 20Ø	€ 18,90
400x100 Bohr. 20Ø	€ 21,50

### Vollgummirad

Plastik-Felge / pannensicher

260x 85 Bohr. 20Ø	€ 19,80
400x100 Bohr. 20Ø	€ 39,90

### Paletten-Hubwagen

mit PU-Tandemrollen

2500 kg € 349,00

### Mefro Schubkarren verzinkte Schüssel

	Inhalt	Breite	€
Mefro Standard	85 ltr.	600 mm	129,00
Mefro Baukarren	90 ltr.	600 mm	139,00
Mefro Export	100 ltr.	750 mm	169,00
Mefro Bully	140 ltr.	750 mm	189,00

### Ersatzschüssel

verzinkt ohne Lochung €

Mefro 85 ltr./600 br.	45,00
Mefro 90 ltr./600 br.	52,50
Mefro 100 ltr./750 br.	68,50
Mefro 140 ltr./750 br.	88,50

Kunststoff mit Loch

Mefro 90 ltr./600 br.	68,00
Mefro 140 ltr./750 br.	105,00
Mefro 200 ltr./780 br.	115,00
Mefro 250 ltr./860 br.	145,00

### Kunststoff-Karren

Mefro 90 ltr. / 600 mm br.	129,00
Mefro 140 ltr. / 750 mm br.	189,00
Mefro 200 ltr. / 780 mm br.	229,00

### Mefro-Kistenkarre

Lufräder 260x85 kugelgelagert 250 kg Traglast Schaufel 480x300

€ 159,00

### Mefro Muldenkuli

250 ltr. Kunststoff Mulde 860 mm breit

€ 349,00

## Kreissägeblätter Edessö

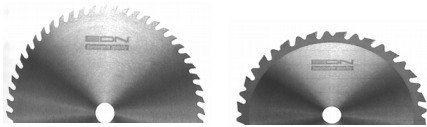

Chromstahl CV			Widia		
			Baukreissägeblätter		
Ø	Bohrung	Wolfszahn	Zähne		
300	30	€ 41,50	20	€	59,00
315	30	€ 41,90	20	€	59,00
350	30	€ 42,50	24	€	77,00
400	30	€ 49,00	28	€	78,00
450	30	€ 68,00	30	€	129,00
500	30	€ 84,00	34	€	145,00
600	30	€ 109,00	42	€	155,00
700	30	€ 159,00	48	€	279,00

## Werkstatt-Papier



Bodenständer 50 cm breit	€	39,50
Wandhalter	€	36,50
Rolle 22cm / 1000Blatt 2-lagig	€	20,50
Rolle 26cm / 1500Blatt 2-lagig	€	33,50
Rolle 38cm / 1000Blatt 3-lagig	€	43,90

## Schraubensicherung

**Niedrigfest 10 gr. blau € 6,60.**  
Schrauben und Muttern lösen sich nicht mehr selbständig.

**Hochfest 10 gr. rot € 6,60**  
sichert zuverlässig Stehbolzen und Gewindeverbindungen bis M20. Schwer demontierbar.

**Superfest 10 gr. grün € 6,60**  
Kleber für Lager und Buchsen



## Lenkrollen und Bockrollen



Ausführung Gummi Ausführung Polyamid

Vollgummi schwarz				
	Tragkraft	Bockrolle	Lenkrolle	mit
		€	€	Bremse
50 Ø	40 kg		6,90	7,90
100 Ø	70 kg	5,50	7,90	12,50
125 Ø	100 kg	7,50	9,90	12,90
140 Ø	125 kg	13,50	14,90	19,80
160 Ø	150 kg	13,90	14,90	19,80
200 Ø	205 kg	18,90	20,90	28,90
Polyamid weiß				
	Tragkraft	Bockrolle	Lenkrolle	
125 Ø	300 kg	7,90	12,90	17,90
160 Ø	350 kg	16,90	22,90	30,90
200 Ø	350 kg	22,80	24,50	33,90

## Reifenreparaturset

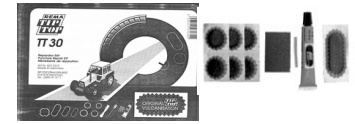

Reifenreparaturset TT 20	22,50
Reifenreparaturset TT 30	41,50
Ventilkappe Metall	0,40
Ventileinsatz PKW	0,40
Ventil-Schraubendreher	4,90
Ventil-Einziehhebel m. Gelenk	9,50
Ventil z. aufkleben PKW	9,90
Ventil z. aufkleben Traktor	25,80
Ventil schlauchlos für Traktor	5,90
Talkum 500 gr.	5,90
Montierpaste 1000 gr.	8,90
Schlauchflicken Gr. 0 30 Ø	0,55
Schlauchflicken Gr. 1 35 Ø	0,60
rund Gr. 2 45 Ø	0,80
rund Gr. 3 54 Ø	1,10
rund Gr. 4 75 Ø	1,40
rund Gr. 5 94 Ø	1,70
rund Gr. 6 115 Ø	2,50
oval Gr. 7 74 x 37 mm	1,10
oval Gr. 7b 150 x 70 mm	2,80
Mantelflicken 150 Ø	9,20
Mantelflicken oval 250 x 180	25,90
Gummilösung 50 gr. Tube	6,20
Gummilösung 175 gr.	10,90
dto. 25 gr. für Mantelflicken	3,50
Liquid-Buffer 250 ml	9,50
Reifenpilot Petec 400 ml	11,50
Tip-Top Reifendichtmittel 1 ltr.	28,90

## Unterstellbock Compac

Stabile Bauart  
fünffach höhenverstellbar



	Bauhöhe	Endhöhe	€
5 to	406 mm	567 mm	95,00
8 to	424 mm	633 mm	148,00
8 to	605 mm	870 mm	189,00

## Unterstellbock



	Bauhöhe	Endhöhe	€
6 to	382 mm	600 mm	59,00
10 to	468 mm	718 mm	98,00

## Montageliege BGS



120x42cm € 119,00

## Montageliege Elora



103x48cm € 69,50

## Compac-Hydraulikwagenheber 3 Jahre Garantie



Hubkraft	Bauhöhe	Endhöhe	€
10 to	230 mm	460 mm	64,50
15 to	230 mm	440 mm	85,50
20 to	242 mm	452 mm	114,00
30 to	275 mm	440 mm	175,00
10 to 3-stufig	215 mm	540 mm	198,00



## Rangierwagenheber

Compac - 3 Jahre Garantie  
Abb. mit Lufräder



Hubkraft / Hubhöhe		€
5000 kg	145 - 560 mm	€ 919,00
10000 kg	165 - 580 mm	€ 1390,00
8000 kg	180 - 960 mm	€ 1550,00
10000 kg	210 - 710 mm	€ 1550,00

Satz Lufräder f. dto. € 119,00

## Reifen-Ventil



zum schrauben  
für schlauchlose Reifen  
€ 5,90

## Reparaturset Sealastic



für schlauchlose Reifen  
10 Stück Set € 64,00

## Dichtungsschaum

zum Abdichten von Motoren,  
Glas, Metall und Plastik,  
bleibt elastisch, -50 / + 200°  
200 ml Sprühflasche € 18,95



## Flüssigmetall Petec

zum Füllen von Rissen und Löchern,  
sowie zur Reparatur an Rohren  
Tanks und Gewinden  
Inhalt 25 ml € 6,40

## Uniplast-Dichtung

Dauerplastische  
Universaldichtung  
für Getriebe  
und Motoren  
80 ml. Tube € 11,50



## Schraubenausdreher

Kunststoffbox  
6-teilig Elora



Größen M3 - M24 € 19,90

## Power Band

selbstverschweißendes  
Reparaturband für  
Schläuche, Rohre  
Temperatur bis 90 Grad  
5 mtr. / 19 mm breit  
Rolle € 8,50



## Gewindedichtung

ersetzt Hanf, Teflon  
und Festdichtungen  
zum Abdichten von  
Gewinden gegen Gas,  
Wasser und Öl  
100 gr. Tube € 18,50



## PowerBand high performance

selbstverschweißendes  
Reparaturband  
Druckbeständig bis 12 bar  
Temperatur bis 265 Grad  
3 mtr. / 25 mm breit  
Rolle € 10,90



## Power BiBond

2 Komponenten Klebstoff  
für Metall, Plastik, hohe Zugfestigkeit  
24 ml. Spritze € 11,90



## Sekundenkleber

Power Kleber Petec  
mit Drehschluß  
kleben von  
unterschiedlichen  
Materialien  
20 gr. Flasche € 10,50



## Montagekleber

Kleben und dichten  
lieferbar in  
weiß, grau, braun  
schwarz und  
transparent  
290 ml Kartusche € 11,90



## Schweiß-Elektroden



	Technolit	Phönix blau
2,50x350 5,0 kg	€ 31,90	69,50 / 4,9kg
3,25x350 5,0 kg	€ 31,90	64,50 / 5,0kg
4,00x350 5,0 kg	€ 31,90	59,50 / 4,7kg
Gußelektroden 3,25 x 350	€ 3,90 je Stück	
Edelstahl 3,25 x 350	€ 3,90 je Stück	

## Schutzgas-Schweißdraht

### SG 2



Rolle 15 kg 0,8 mm	€ 52,90
Rolle 15 kg 1,0 mm	€ 49,90
Kupferdüsen 0,8 mm	€ 1,40
Kupferdüsen 1,0 mm	€ 1,40
Gasdüse TB 25	€ 6,90

## Handschuttschild

komplett mit Gläsern € 13,50  
Fiberglas EWO € 32,50



Ersatzglas 9x11 hell € 0,40  
Ersatzglas 9x11 dunkel € 2,70

## Automatik-Schweißmaske



EWO 913 ASD  
€ 119,00

DIN 9-13  
Sichtfeld 100x50mm  
Schaltzeit  
0,1-0,8 Sekunden

Elektrodenhalter	Massezange	Schweiß-Kabel	Kabelschuh	Schweiß-Magnet	Schutzbrille
300 Amp. € 19,50		per mtr.	für Schweißkabel		Nylon hell € 4,90
400 Amp. € 21,90	400 Amp. € 10,50	35 mm <sup>2</sup> € 10,50	35 mm <sup>2</sup> € 2,20	120 x 80 mm € 7,50	Nylon dunkel € 4,90
600 Amp. € 22,90	600 Amp. € 13,90	50 mm <sup>2</sup> € 11,50	50 mm <sup>2</sup> € 2,70	190 x 120 mm € 13,90	Modell 34671 € 4,50

## Chemie-Produkte

	Stück	ab 5 St.
Rostlöser MoS <sup>2</sup> 400 ml	€ 3,50	€ 3,20
5 ltr. Kanister	€ 31,90	
WD 40 400 ml	€ 10,50	€ 9,90
5 ltr. Kanister	€ 64,90	

Aluminium-Spray 400 ml	5,60
Aluminium-Spray 400 ml/Weicon	7,30
Ballistol-Spray 200 ml	7,90
Ballistol-Spray 400 ml	12,90
Bremsflüssigkeit DOT 4 1000 ml	12,50
Bremsenreiniger 500 ml	3,50
ab 5 Dosen	3,20
Bremsenreiniger 5 ltr. Kanister	23,90
Cockpitstray 400 ml	5,30
Gewindedichtung 100 gr.	19,90
Frostschutz f. Druckluftbremse 1 ltr.	9,90
Forstmarkierungsspray rot 500 ml	6,50
Haftschmierspray Kim-Tec 400 ml	5,40
Haftschmierspray Petec 500 ml	8,50
Kaltreiniger 5 ltr. Kanister	24,90
Keilriemenspray 400 ml	5,60
Keramikpaste für Bremsen 50 gr.	6,70
Kettenspray Kimtec 400 ml	4,30
Ketten- u. Seilspray Weicon 400 ml	8,50
Kontaktspray 400 ml	4,50
Kühlerdichtmittel 300 ml	5,80
Kühlerfrostschutz 5 ltr. Kanister	18,90
Kühlerfrostschutz 20 ltr. blau	64,90
Kühlerfrostschutz 20 ltr. rot	79,90
Kupfergleitspray 400 ml	6,70
Kupferpaste 500 gr.	17,90
Leckfinder 400 ml	4,30
Montageschaum activ 500 ml	6,70
Motorstarter 400 ml	5,10
Motorstarter Startpilot Org. 300 ml	9,95
Multifunktionsspray WET40 400 ml	4,90
Multifunktionsspray Petec 500 ml	5,90
Scheibenklar bis - 60 ° 5 ltr.	11,95
Scheibenreinigerschaum 400 ml	3,80
Schweißschutzpaste 300 ml	17,80
Schweißspray 400 ml	3,40
Sekundenkleber 10 gr. Petec	6,90
Silikonspray 400 ml	4,50
PTFE-Trockengleitspray 400 ml	6,70
Universalfettspray weiß 400 ml	5,60
Unterbodenschutzspray 500 ml	9,60
Zinkspray 400 ml Kim-Tec	5,60
Zinkspray 400 ml Weicon	8,90
Zink-Alu Spray 400 ml	5,60



## Landmaschinenfarbe Kunstharz

### Büchner - Erbedol

Amazone grün  
Amazone orange  
Bergmann grün  
Brantner grün  
Case rot  
Case silber  
Claas dunkelgrau  
Claas rot  
Claas saatengrün  
Deutz hellgrün  
Deutz dunkelgrün  
Deutz grün alt  
Deutz schwarzblau  
Deutz silber  
Eicher blau  
IHC rot  
IHC weiß  
John Deere gelb  
John Deere grün  
Fella rot  
Fendt grau  
Fendt grün  
Fendt nature green  
Fendt rot  
Fiat blau



750 ml  
Dose  
€ 17,90



Kemper rot  
Krone rot  
Krone grün  
Kvemeland grün  
Lemken blau  
Mengele blau  
Mengele rot  
MF grau  
MF silber  
New Holland blau  
New Holland gelb  
Niemeyer rot  
orange  
Rabe blau  
Rau rot  
Reisch grün alt  
Reisch grün neu  
Reisch rot  
Schlüter rot  
Stoll gelb  
schwarz matt  
schwarz glanz  
Welger rot  
Welger grün  
Unsinn rot

weitere Lacke  
auf Anfrage für € 21,90 lieferbar



## Lackierpistole



Standard € 29,50

EWO im Koffer € 98,00

## Feinstaubmasken

KN95 ungiftige feste und flüssige Aerosole mit Ventil 5 St.	€ 6,95	
FFP2 mindergiftige feste und flüssige Aerosole ohne Ventil 20 St.	€ 20,00	
FFP2 mindergiftige feste und flüssige Aerosole mit Ventil 10 St.	€ 22,90	
FFP3 hochgiftige feste und flüssige Aerosole mit Ventil 5 St.	€ 23,90	

## Farbspray



400 ml Spraydose € 16,90

## Grundierung



grau oder rotbraun

400 ml Spraydose € 4,95  
750 ml #270341 € 14,50  
2,5 ltr. #270342 € 44,90

## Roststabilisator



Rost-Stop 750 ml € 17,90  
Rost-Stop 2500 ml € 54,90  
Umwandler Spray 400 ml € 9,80

## Verdünnung / Härter



1 ltr. Universal € 5,90  
6 ltr. Universal € 29,50  
1 ltr. Nitro-Verdünnung € 5,90  
6 ltr. Nitro-Verdünnung € 29,50  
1 ltr. Härter-Verdünnung € 21,90  
3 ltr. Härter-Verdünnung € 59,50

## Sortiment Pinsel



5 tlg. € 7,95

10 tlg. € 11,90

## Kreppband weiß

30 mm x 50 mtr.  
€ 2,50



## Maschinensägeblätter

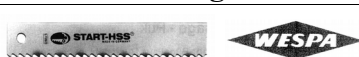

300x25x1,5 mm	€ 9,90
350x30x1,5 mm	€ 13,90
400x25x1,5 mm	€ 12,90
400x30x1,5 mm	€ 14,90
400x35x2,0 mm	€ 19,90
450x35x2,0 mm	€ 22,50
500x40x2,0 mm	€ 29,50

## Metall Handsägebogen



Fabr. Elora € 14,90

Ersatzblatt HSS 300 lg € 1,20  
ab 10 Stück € 1,10

## Klebeband 50mm 50 mtr.



Gewebeband grau € 8,90  
Panzerklebeband schwarz € 9,80





Mann	€	Nachbau	€
H614/3	35,20		
H724/1 =/3	77,90	Fendt 514.860.060.210	
H729	9,90		
H928/1	9,20		
H932/2t	9,80		
H1059/2	37,70		
H9005	92,90	916.100.490.010	84,40
<b>HD722</b>	<b>68,90</b>	916.100.600.010	
HD811	86,90	H411.101.490.100	
HD836/2	86,50		
HD15005x	98,00	285.102.050.010	71,50
HU719/7x	9,10		
HU931x	12,70		
<b>HU931/6x</b>	<b>16,80</b>	Fendt 411.201.510.010	
HU931/7x	23,20	Fendt 836.200.510.010	
HU932/4x	9,20		
HU938/1x	11,20		
HU945/2x	11,50		
<b>HU945/3x</b>	<b>18,20</b>	Fendt 716.200.510.020	
HU947/1n	14,50		
HU947/1x	10,20		
HU947/2x	14,40	1.457.429.107	11,90
HU951x	10,50		
H1263/1x	18,20		
HU12015x	24,20	LF16043	
H12110/2x	17,20	LF3327	
HU13125/3x	19,90	LF17056	
HU12140x	19,90		
W712/4	8,30		
W719/4	10,20		
W719/5	8,20		
W723/3	7,50		
W811/80	6,40		
W920/23	11,90		
W925	26,50	LF3703	15,70
W930	11,30		
W930/7	10,70	23.185.00	7,50
W936/4	9,50		
<b>W940</b>	<b>10,40</b>	<b>23.241.00</b>	<b>6,60</b>
<b>W940/5</b>	<b>10,50</b>	<b>23.110.02</b>	<b>6,90</b>
W940/24	11,20	LF701	13,20
W940/25	11,30	23.164.00	6,90
W940/91	17,20		
W950/7	14,20		
W950/17	15,20	LF3331	16,20
W950/18	13,60	LF3349	13,60
W950/26	20,40	LF16015	23,90
W950/44	20,40	LF3468	17,60
<b>W962=/6</b>	<b>14,50</b>	<b>23.106.01</b>	<b>12,90</b>
W962/47	15,40	Deutz 01182672	
W9019	18,40	84228490	
W9071	23,20	SP4928	17,80
<b>W1022</b>	<b>21,90</b>	<b>LF16243</b>	<b>20,50</b>
W1130	13,30		
W1140	14,80	23.108.01	12,90
<b>W1140/11</b>	<b>18,20</b>	LF3783	
W1150/2	14,90		
W1160	17,60	LF3506	18,90
W1254x	29,70	LF3567	24,60
W8005	18,50	23.107.01	15,20
W10050	19,40	LF17509	25,20
W11102	29,40	LF4112	24,80
W11102/28	35,70		
W11102/36	16,20		
W11102/37	19,20	LF17513	
W11007	14,20		
W11008	16,90		
WD950/2	24,90		
WD950/3	18,50		
WD950/4	23,50	HF6267	20,80
WD950/5	22,20	HF28818	26,20
WD962	22,40	HF6141	30,50
WH945	38,80	HF6554	57,30
WH980/3	44,20	HF6553	53,90
WH1263	91,40	HF35305	94,90
WP12308	39,50	LF3548	40,90

MANN	€	Nachbau	€
BFU700x	8,40		
BFU707	8,90		
BFU900x	8,90		
P707	7,20		
P917x	10,90	FF167A	4,50
P945x	15,40	FF4052A	10,40
<b>PU815x</b>	<b>16,40</b>	F716.201.060.070	
PU840x	52,80	F339.202.060.210	
PU911	22,40	F731.201.060.010	
PU999/1x	17,80	FF5405	19,20
PU1058x	22,70		
<b>PU1058/1x</b>	<b>35,70</b>	F731.200.060.020	
U5001 KIT	51,10	F835.201.110.090	
WDK725	13,60	FS19599	14,40
WDK962/1	32,20		
WK1060/5x	49,80		
<b>WK1070x</b>	<b>55,40</b>	SK3398	37,80
WK31/5	3,50		
WK712/2	7,40		
WK716/2x	22,40	FS1251	26,50
WK723	8,60	FF5074	6,10
<b>WK731</b>	<b>7,50</b>	<b>24.307.00</b>	<b>6,80</b>
<b>WK842</b>	<b>11,90</b>		
WK842/2	12,50	FF5135	14,50
WK842/6	31,40		
WK962/4	13,80		
WK929x	18,60	FF5421	20,90
WK950/16x	48,20	FS1212	25,90
WK8100	32,20	RE62418	
WK8102	29,40	RE62419	
WK8106	38,20	FF5045	41,90
WK8114	37,20	FS19827	36,30
WK8131	26,40	FS19829	29,20
WK8145	30,90	FS19833	30,50
WK8153	33,90	FS19826	33,40
WK8155	30,60	FS19830	27,20
WK8156	37,90	RE529644	
WK8161	37,20	RE529643	
WK8162	35,90	RE522878	
WK8163	33,20	(=WK8164)	
WK8165	38,60		
WK8166	32,60	RE526557	
WK8168	117,90		
WK8173	54,70	RE544394	
WK8179	52,40	RE546336	
WK8187	45,70	RE541922	
WK8188	53,40	RE541925	
WK9042x	25,40	SK3339	28,40
WK9165x	21,40	FS1280	17,90
WK13001	20,20	AR50041 = FF203	24,50

**ab 10 Stück sortiert  
10% Mengenrabatt**



**Ölfilterschlüssel - Elora**

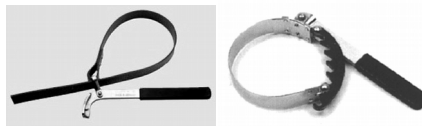

Art.-Nr.		Ø	€
190-80	Metallband	80-110 mm	33,20
187-160	Bandschlüssel	bis 160mm	30,90
187-280	Bandschlüssel	bis 280mm	51,90
187-180	für Ratsche 1/2"	bis 180mm	45,90

Mann	€	Nachbau	€
<b>Luftfilter</b>			
C1342	42,20	AF25301	40,90
C1374/2	60,90	AF25334	65,50
<b>C13114/4</b>	<b>25,90</b>	<b>27.881.00 = SL6208</b>	<b>21,60</b>
<b>C15165/3</b>	<b>29,50</b>	<b>27.828.00 = SL6212</b>	<b>26,90</b>
C14210/2	26,60		
C15300	33,40		
C16302	41,20	AF4059K	44,80
C16340	54,40		
C16400	40,40	AF 26393	46,90
<b>C17134</b>	<b>23,60</b>	<b>AF4137</b>	<b>30,40</b>
C17201	40,60		
<b>C17225/3</b>	<b>41,40</b>	<b>Bosch 1.457.429.946</b>	<b>29,50</b>
C17250	32,80	AF991	41,60
C17337/2	32,70	AF25557	29,90
C19384/1	69,50	AF25300	70,90
C19397		AF26175	42,20
C19450	53,70		
C19460/2	42,20	AF25957	57,30
C20015	57,90	AF26284	57,50
<b>C20325/2</b>	<b>59,50</b>	<b>AF25064 = E115L</b>	<b>46,90</b>
C20500	46,40	AF26395	50,50
C21600	44,80		
C21630/3	42,80	AF25492	44,20
C21630/4	46,20	AF25964	58,20
C21560/2	45,20	AF25504	59,40
<b>C23440/1</b>	<b>54,40</b>	<b>AF25065=27.805.00</b>	<b>49,90</b>
C23589/1	105,00	AF25341	104,90
<b>C24650/1</b>	<b>59,40</b>	<b>Bosch 1.457.429.975</b>	<b>54,50</b>
C25710/3	81,20		
C30400/1	85,80		
<b>C30850/2</b>	<b>69,00</b>	<b>AF1802</b>	<b>74,90</b>
C33920/3	135,00	AF25062	169,00
C34540/1	71,80		
CP25150	63,90		
CP33280	139,00	E1561L	54,90
CP33300	83,50	SL82001 = E712L	73,20
CP33530	99,60	SL82002	85,40
CP33540	139,00	SL82014	117,90
<b>Kabinenfilter</b>			
C30154		SKL2545	32,70
C48140	27,90	SKL2546	27,20
C55102		SKL46006	27,20
C60148		SKL2547	30,90
CU2136	12,90	L155288	
CU3564	17,90		
CU4197/2	24,90		
CU16400	39,50	SKL46280	46,60
CU24014	17,30		
CU57218	29,50	SKL46488	41,40
<b>Sicherheitspatronen UFI / AF = Fleetguard</b>			
CF300	25,40		
CF400	35,80		
CF450	42,50		
CF500	35,40	E1900LS	29,50
CF600	32,80	E112LS	27,80
CF610	43,40		
<b>CF700</b>	<b>30,70</b>		
CF710	59,90	E630LS	49,90
CF711	26,90		
<b>CF800</b>	<b>33,50</b>	<b>E114LS</b>	<b>29,50</b>
CF810	68,00		
CF830	39,00		
CF850/2	19,50		
CF922	28,40	E567LS	19,50
CF990/2	18,70		
<b>CF1000</b>	<b>42,20</b>	<b>AF1840</b>	<b>37,70</b>
CF1140/2	31,40	AF25491	33,20
CF1141/2	27,40	AF25618	43,30
<b>CF1200</b>	<b>42,90</b>	<b>AF1841</b>	<b>39,90</b>
CF1300	50,70	AF1843	49,90
CF1600	54,90	AF4523	60,40
CF2100	205,00	AF25230 = E119LS	169,00
CF2120	36,20		
CF2631	53,20		
CF2944	44,20		
CF3240	73,20	SL82012	62,50
CF10001	58,70	AF26294	61,90
CF30100	43,70	SL82003	43,90

passend für	Ölfiler	Luftfilter	Sekundär-Luft	Kraftstoff	Vorfilter	Hydraulik	Kabinenfilter
<b>Fendt (Sisu) Vario 209-211</b>	W940/91 € 17,20	CP25150 € 63,90	CF2120 € 36,20	WK8163 € 33,20	WK8165 € 38,60	HD722 € 68,90	SKL2545 € 32,70
<b>Fendt (Deutz) Vario 309-312</b>	HU931/6x € 16,80	C19460/2 € 42,20	CF1141/2 € 27,40	PU840x € 52,80	WK1070x € 55,40	HD722 € 68,90	CU4197/2 € 24,90
<b>Fendt (Sisu) Vario 309-312</b>	W1140/11 € 18,20	CP33280 € 139,00	CF30100 € 43,70	U5001 KIT / Adblue € 51,10			CU24014 € 17,30
<b>Fendt Vario 409-415</b>	HU931/6x F411.201.510.010 € 16,80	C19460/2 H411.201.090.100 € 42,20	CF1141/2 H411.201.090.110 € 27,40	PU815x € 16,40 oder PU840x € 52,80	WK1070x F339.202.060.120 € 55,40	HD722 F916.100.600.010 € 68,90	CU4197/2 € 24,90 C48140 € 27,90
<b>Fendt Vario 512-516</b>	HU931/6x F411.201.510.010 € 16,80	C30400/1 H416.200.090.100 € 85,80	CF2631 H416.200.090.110 € 53,20	U5001 KIT / Adblue F835.201.110.090 € 51,10	WK1070x F842.201.060.010 € 55,40	HD722 F916.100.600.010 € 68,90	CU57218 € 29,50 CU3564 € 17,90
<b>Fendt Vario 712-716 Serie I + II</b>	HU945/3x F716.200.510.020 € 18,20	C21630/4 H716.200.090.100 € 46,20	CF1140/2 H716.200.090.110 € 31,40	PU815x F716.201.060.070 € 16,40		HD722 F916.100.600.010 € 68,90	CU4197/2 € 24,90 C48140 € 27,90
<b>Fendt Vario 712-718 Serie III</b>	HU945/3x F716.200.510.020 € 18,20	C21630/3 1/3 geschlossen € 42,80	CF1140/2 H716.200.090.110 € 31,40	PU1058x € 22,70 oder PU1058/1x € 35,70	PU 911 F731.201.060.010 € 22,40	HD722 F916.100.600.010 € 68,90	CU4197/2 € 24,90 passend für C48140 € 27,90
<b>Fendt Vario 720-724 Serie III</b>	HU931/7x F836.200.510.010 € 23,20	C34540/1 H737.200.092.100 € 71,80	CF2944 H737.200.092.110 € 44,20	PU1058/1x F731.200.060.020 € 35,70	WK1070x F339.202.060.120 € 55,40	HD722 F916.100.600.010 € 68,90	CU57218 H737.812.140.010 € 29,50
<b>Fendt Vario 820</b>	HU945/3x F716.200.510.020 € 18,20	C21630/3 1/3 geschlossen € 42,80	CF1140/2 H716.200.090.110 € 31,40	PU1058/1x F731.200.060.020 € 35,70	PU 911 F731.201.060.010 € 22,40	HD722 F916.100.600.010 € 68,90	
<b>Fendt Vario 930-936 ab Bj. 2006</b>	W11102/28 F934.201.510.320 € 35,70	CP33540 H931.202.090.410 € 139,00	CF3240 H931.202.090.400 € 73,20	WDK962/1 F934.201.060.010 € 32,20	WK1070x F339.202.060.120 € 55,40	HD722 F916.100.600.010 € 68,90	CU16400 H931.812.140.600 € 39,50



alle Filter Org. Mann Filter - Org. Fendt Nummern dienen nur zum Vergleich

(Donaldson/Fleetguard/MANN)			
	Vergleich-Nr.	passend für Fendt	€
U5001 KIT	F835.201.110.090	AdBlue-Filter	51,10
HY10008	F180.100.050.290	Hydraulikfilter	88,90
HY10009	F285.102.050.010	Hydraulikfilter = HD15005x	71,50
HY9895	F916.100.490.010	Hydraulikfilter Vario = H9005	84,40
HY10244	G716.860.060.310	Hydraulikfilter Vario = H7010	74,50
H724/3	G117.862.060.260	Hydraulikfilter	77,90
C21600	H743.200.090.100	Luftfilter	44,80
		<b>passend für New Holland</b>	<b>€</b>
LF708	81879130	8340 / M135	13,70
LF17509	87679600		25,20
AF25371	82008610	Luftfilter M135/M160	106,90
AF25457	82008610	Luftfilter M135/M160	48,30
HF28885	82005020	Hydraulikfilter M135/M160	72,50
HD1044/2	1930882	Hydraulikfilter M110/M115	29,90
FS19826	836862600	Kraftstoff-Filter	33,40
FS19827	836862600	Kraftstoff-Filter	36,30
		<b>passend für Massey Ferguson</b>	<b>€</b>
FS20052	2656F853	MF 6465 / 6475 / 6480 = SK3176/2	49,90
FF261	2656F843	MF 6465 / 6475 / 6480 = SK3177	49,50
C18267	1062501M91	MF 6160	65,20
CF922	1093683M91	MF 6160	28,40

(Donaldson/Fleetguard/MANN)			
	Vergleich-Nr	passend für John Deere	€
CU2136	L155288	Kabinenfilter innen	12,90
SKL46188	AL119095	AL177184 Kabine außen	39,20
P606119	AL119839	AL172780/CP33300/ 6020-6420	71,20
P606120	AL150285	AL172781/CP33530/ 6520-6920	83,20
P606121	AL150288	CF30100/ 6020-6920 oval klein	42,70
AF25358	RE34966	7800 (außen)	77,90
AF25361	RE34967	7800 (innen)	43,40
HF6553	RE39527	AL118036 - 7000er Serie	53,90
HF6554	AL77061	6100-6600	57,30
HF6555	RE34958	Hydraulikfilter	55,60
HF6557	AH128449	Hydraulikfilter	68,60
HF35305	AT129775	Hydraulikfilter (WH1263)	89,50
HF35340	AL118321	Hydraulikfilter	86,90
HF35474	AL156625	Hydraulikfilter (WH10008)	60,20
HF35343	AL160771	Hydraulikfilter	87,90
P958404	AL169573	Hydraulikfilter AL169059	89,50
LF3567	RE57394	47/4955/77-7800/8100/8400	24,60
LF3703	RE59754	6010 - 6910	15,70
HU12015x	RE509672	7210R - 7290R Filtereinsatz	24,20
<b>LF16243</b>	<b>RE504836</b>	<b>6020 - 6920 / 6030 - 6930</b>	<b>20,50</b>
LF16460	RE539279	6140R-6190R =SP4910/2 =W1022/1	21,90
WK8100	RE62418	Kraftstoff-Filter	32,20
WK8102	RE62419	Kraftstoff-Filter	29,40
FS19829	RE509031	Kraftstoff-Filter	29,20
FS19833	RE509032	Kraftstoff-Filter	30,50
FS19906	RE509036	Kraftstoff-Filter	38,20
FS19830	RE509208	= RE517181	27,20
WK8162	RE522878	Kraftstoff-Filter 30er Serie	35,90
WK8166	RE526557	Kraftstoff-Filter 30er Serie	32,60
WK8161	RE529643	Kraftstoff-Filter 30er Serie	37,20
WK8156	RE529644	Kraftstoff-Filter 30er Serie	37,90
WK8187	RE541922	Kraftstoff-Filter	45,70
WK8188	RE541925	Kraftstoff-Filter	53,40
WK8173	RE544394	Kraftstoff-Filter	54,70
WK8179	RE546336	Kraftstoff-Filter	52,40

Filter für Biogasmotoren					
	Mann/Bosch	Vergleich-Nr	€	ab 10 St.	ab 50 St.
Ölfiler	H12110/2x		17,20	15,55	14,65
Ölfiler	0451.301.207	W1160	15,90	14,35	13,55
Ölfiler	W11102/37	LF3730 / 1015158	19,20	17,25	16,35
Ölfiler	1457.429.107	HU947/2x	11,90	10,75	9,95
	Fleetg/SF	Vergleich-Nr	€	ab 5 St.	ab 10 St.
Luftfilter	SL8435		43,60	39,25	37,05
Luftfilter	C21560/2	B679 / P77-7588	45,20	40,65	38,45
Luftfilter	AF25313	1421021 / 1-015-159	74,90	67,45	63,65
Luftfilter	AF26124	RS5429	99,00	89,95	85,45
Luftfilter	SL81254	PA2751	69,00	66,45	63,95

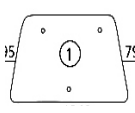
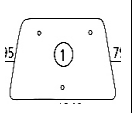
## Scheiben für Schlepperkabine

			
passend für	Frontscheibe	Heckscheibe	Türscheibe
Case 743-1455XL	€ 199,00	€ 49,90	€ 49,90
Case CS + CVX		ohne Wischer	
Steyr CVT	€ 179,00	€ 125,00	€ 169,00
Fendt Farmer / GT alte Kabine	€ 109,00	€ 125,00	€ 69,00
Farmer / Favorit neue Kabine	€ 249,00	€ 139,00	€ 339,00
John Deere fest 6010 - 6930	€ 299,00	€ 189,00	€ 199,00

**weitere Typen sofort lieferbar**

## Panther Starterbatterien gefüllt + geladen

Batteriepfand bis 100 AH € 12,50 / ab 110 AH € 25,00

Kapazität	Socket	Kältestrom	Maße LxBxH	€
12 V 30 AH	mit	300 A	186x131x171 mm	55,00
12 V 44 AH	mit	360 A	212x175x175 mm	65,00
12 V 55 AH	mit	420 A	247x175x175 mm	69,00
12 V 66 AH	mit	510 A	278x175x190 mm	89,00
12 V 74 AH	mit	680 A	278x175x190 mm	99,00
12 V 90 AH	mit	720 A	353x175x190 mm	99,00
12 V 100 AH	mit	760 A	353x175x190 mm	119,00
f. Claas 120 AH	ohne	780 A	347x175x234 mm	179,00
f. J.D. 110 AH	mit	850 A	413x175x220 mm	175,00



**Garantie 24 Monate**



Kapazität	Socket	Kältestrom	Maße LxBxH	€
12 V 110 AH	mit	760 A	514x175x210 mm	149,00
12 V 120 AH	ohne	680 A	513x189x223 mm	169,00
12 V 135 AH	mit	1000 A	514x175x210 mm	179,00
12 V 140 AH	ohne	760 A	513x189x223 mm	179,00
12 V 143 AH	ohne	900 A	513x223x223 mm	199,00
12 V 143 AH	mit	950 A	513x218x210 mm	199,00
12 V 154 AH	ohne	1300 A	513x189x223 mm	229,00
12 V 170 AH	ohne	1000 A	513x223x223 mm	229,00
12 V 174 AH	ohne	1500 A	513x223x223 mm	259,00
12 V 180 AH	ohne	1000 A	513x223x223 mm	225,00
12 V 180 AH	mit	1200 A	513x223x223 mm	265,00
12 V 180 AH	ohne	1400 A	Org. Varta	269,00
12 V 225 AH	ohne	1150 A	518x274x242 mm	279,00

## Antriebsbatterie Panther 12 Monate Garantie

Kapazität	DIN-Nr.	Maße LxBxH	€
60-80 AH	95602	278x175x175	135,00
75-90 AH	95752	353x175x175	159,00
180-230 AH	96801	518x274x242	359,00



## Hochleistungs Batterie Panther

gefüllt und geladen + 30% Startleistung  
wartungsfrei mit Ladekontrollanzeige



m. Sockelleiste	Kältestrom	Maße LxBxH	€
12 V / 45 AH	450 A	211x175x190	69,00
12 V / 55 AH	530 A	211x175x190	82,00
12 V / 65 AH	650 A	246x175x190	92,00
12 V / 75 AH	750 A	278x175x190	99,00
12 V / 85 AH	850 A	317x175x190	125,00
12 V / 95 AH	950 A	353x175x190	129,00

## Start-Stopp Batterie AGM

**Panther**



m. Sockelleiste	Kältestrom	Maße LxBxH	€
12 V / 60 AH	680 A	242x175x190	135,00
12 V / 70 AH	760 A	278x175x190	145,00
12 V / 80 AH	800 A	315x175x190	159,00
12 V / 95 AH	850 A	353x175x190	185,00
12 V / 105 AH	950 A	393x175x190	209,00

## HORN Dieselpumpen Hornet



### Hornet W 50 II

Grundset  
selbstansaugend  
220 Volt 55 ltr/min  
1,6mtr. Saugschlauch  
4,0mtr. Druckschlauch



### W 40 - 220 V

38 ltr/min  
€ 229,00

38 ltr/min  
Automatik  
Zapfpistole  
€ 339,00

Zapfpistole - Automatik € 549,00  
Ersatzpumpe lose € 349,00  
Ersatzpumpe Piusi 50ltr. € 229,00

4 mtr. Druckschlauch, Zapfpistole,  
1,6 mtr. Saugschlauch mit Fußventil



### Hornet W 50 II mit Zählwerk

selbstansaugend 55 ltr.  
1,6mtr. Saugschlauch  
4,0mtr. Druckschlauch

Zapfpistole - Automatik € 669,00

Dieselschlauch 3/4" Gummi € 6,50  
Dieselschlauch 1" Gummi € 9,90  
Zählwerk analog € 119,00  
Zapfpistole Standard Plastik € 17,50  
Zapfpistole Automatik € 139,00  
mit Bauartzulassung Mod. Hornet  
ab 1000 ltr. Tank erforderlich

## Schlauch 3/4"

4 mtr. € 41,50  
6 mtr. € 52,50  
8 mtr. € 71,50  
fertig verpreßt 2 x Gewinde 1"

## Schlauchstutzen Messing

3/4" € 2,90  
1" € 2,90



## Fußventil Messing

3/4" € 11,90  
1" € 14,95



## Batterie Optima YTS 5.5 gelb 1050 / 975A

L 325x B 165 x H 238 mm  
geringe Selbstentladung € 359,00



## Starthilfe-Kabel (1 Satz)



350A/25mm<sup>2</sup>/3,5m. Plastikzange € 24,90  
480A/35mm<sup>2</sup>/4,5m. Plastikzange € 39,50

## Batterie Optima rot 1050 / 815A

L 245x B 172 x H 199 mm  
geringe Selbstentladung € 225,00



## Starthilfe-Kabel (1 Satz)



(1) 50mm<sup>2</sup> / 5,0m Gußzange € 109,00  
(2) 70mm<sup>2</sup> / 6,0m Gußzange € 119,00  
(2) 70mm<sup>2</sup> / 9,0m Gußzange € 149,00  
gekröpfte vollisolierte Zangen

## Hochfrequenzladergerät

hält Batterien immer  
Einsatzbereit  
können dauerhaft  
angeschlossen bleiben  
CETEC durch Pulserhaltungsladung  
5 Jahre Garantie

MXS 5 / 5A € 94,50



## Ersatzzangen vollisoliert

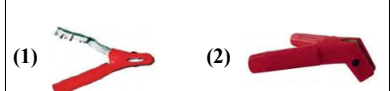

(1) 80 Amp. Stahlblech € 3,50  
(1) 300 Amp. Stahlblech € 14,90  
(2) 1000 Amp. gekröpft € 36,90

## Batterie-Trennschalter

100 Amp. € 16,90  
250 Amp. € 42,50



## Frostschutzprüfer Glycomat

20 cm Schlauch  
€ 15,95



## Säureheber € 14,95



## Polklemmenreiniger

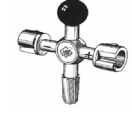

€ 12,50



€ 3,90

## Batterieladegerät

EV05  
6 - 12 V  
5 Ampere  
€ 79,00



iQ 15000 Plus  
12 / 24 V  
15 Ampere  
€ 149,00



## Massebänder

25mm<sup>2</sup> / 300 lg. 8,90  
25mm<sup>2</sup> / 400 lg. 11,90  
35mm<sup>2</sup> / 400 lg. 18,50  
50mm<sup>2</sup> / 500 lg. 20,90

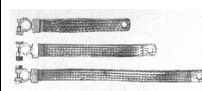

## Batterieklemmen

PKW € 2,80  
Traktor stabil € 3,70  
Polfett 50 ml € 3,95  
Polspray 400ml € 5,95



Leuchtsatz Connix		Big-Bag Auslauf		Alu-Schaufel Gr. 9	
Funk kabellos mit Magnet LED 12/24 Volt aufladbar		#29428 mit Handschieber	#29389 Mod. Raimo	2,0 mm dick Standard	2,5 mm verstärkt Profi
€ 99,00		€ 115,00	€ 99,00	ab 5 Stück € 10,90	ab 5 Stück € 12,90
				ab 5 Stück € 9,90	ab 5 Stück € 11,90

MANN FILTER Filter Org. MANN				MANN FILTER		Filter Fleetguard	
W962/6	HU931/6x	HU945/3x	W9019	PU840x	PU1058/1x	LF16243	LF16460
€ 12,95	€ 14,95	€ 15,95	€ 15,95	€ 46,95	€ 31,95	pass. f. RE504836 € 18,45	pass. f. RE539279 € 19,75



Stallreiniger	Fahrzeugreiniger	Sprühöl SMB	Melkeimer	Futterspielball
alkalischer Reiniger Dosierung 1 – 10 % Konzentrat	Intensiv- reinigungs- konzentrat auf Schaum- basis		rot blau oder grün	
5 ltr. Kanister € 38,50	5 ltr. Kanister #299411 € 38,50	5 ltr. € 22,50 20 ltr. € 74,90	Kunststoff 30 ltr. € 89,90	HeuBoy blau € 39,90

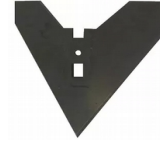
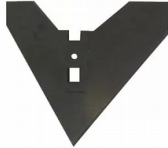

PVC – Streifenvorhang 3 mm				Arbeitshandschuhe		
		Hakenleiste		Gr. 8 – 12	Gr. 7 – 11	Gr. 9 – 11
25 mtr. x 30 cm € 109,00	50 mtr. x 30 cm € 215,00	100 cm € 16,50	150 cm € 25,90	gefüttert #1457 je Paar € 4,50	PowerGrab ab 6 Paar € 4,50	Solidstar #1451 je Paar € 2,20
Pendelblech 30 cm € 3,20		200 cm € 34,90		ab 6 Paar € 3,95		ab 12 Paar € 1,95

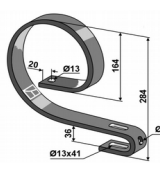
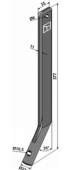
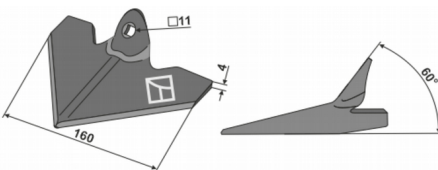
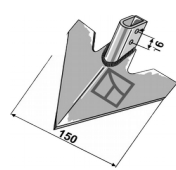
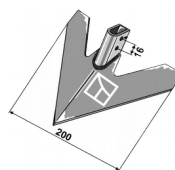
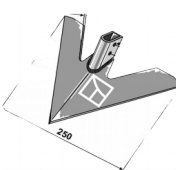
Dunlop Purofort m. Stahlkappe			Nora Sicherheitsstiefel S5		
bis -20°C	bis -20°C	bis -50°C	bis -20°C	bis -40°C	bis -50°C
Purofort S5 Gr. 37-48 € 67,90	Purofort S5 Plus Gr. 36-49 € 86,50	Thermo Plus Gr. 37-48 € 119,90	Noramax Gr. 36 - 49 € 56,90	Noracomp Gr. 37 - 49 € 78,90	Noratherm Gr. 39 - 48 € 99,90

Luftstuh PROBOSS		Fingerhacke	Hackschare passend für Schmotzer			
mit verstellbaren Armlehnen und Rückenverlängerung mechanische Bandscheibenstütze Polsterbreite 48 cm Sitzhöhe 24-34 cm		Halter mit Stern 370 mm  für Reihenweiten 55-75cm				
				Rapido Schnellwechselsystem		
				100 / 120 mm	140 / 160 / 180 mm	200 / 240 mm
PROBOSS AS2480 € 749,00		€ 249,00	€ 11,90	€ 13,50	€ 13,90	

passend für Einböck				passend für Hatzenbichler		
						
Oberfeder	Stiel	Hackschare		R409456	R409463	R409915
40x12 mm	35x11mm	160 mm	240 mm	150 mm	200 mm	250 mm
€ 49,95	€ 20,90	€ 11,90	€ 14,90	€ 9,95	€ 11,50	€ 19,90
		200 mm	300 mm			
		€ 12,90	€ 15,90			

Spanngurte 4000 kg / 2-teilig			Radmontagewagen	
				
8 mtr. x 50 mm	10 mtr. x 50 mm	15 mtr. x 50 mm	max. Reifengröße 2200 x 800 mm	
€ 9,90	€ 12,90	€ 17,90	€ 899,00	
			max. Reifengröße 2200 x 1100 mm	
			€ 1249,00	

Ernteschutzvlies	Reifenfüller	Calz-o-Phos	Calzogol Bolus
grün 130 gr./m <sup>2</sup> 		 zur Versorgung von Kühen mit Kalzium und Phosphor	
atmungsaktiv	Clip zur Fixierung	500 ml Flasche	Kalzium 45 gr. je Bolus
10,4 x 12,5 mtr. € 209,00	2 - teilig	je Stück € 5,95	Vitamin D3 (40000 I.E.)
10,4 x 25,0 mtr. € 418,00	€ 2,80	ab 12 Stück € 5,50	4 x 175 Gramm
13,0 x 25,0 mtr. € 525,00		ab 24 Stück € 4,95	#15980 € 23,90

passend für Kverneland				Weidezaungerät mit Zaunkabel	
73006/07	73080/81	53090/63090	53090/63090	Kerbl A1000	AKO X2 Smart
					
		verstärkt	beschichtet	Spannung 4000 Volt für kleine Zäune	Spannung 7300 Volt per App steuerbar
€ 29,90	€ 37,90	15 mm stark	€ 18,90	12 Volt Gerät	DUO 12 und 230 Volt
		€ 7,50		€ 89,00	€ 339,00