

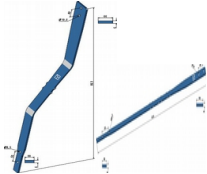



# Gülle-Zubehör

Gülle Flanschschieber Messing Fabr. MZ			passend für Bomech				pass. f. Flieg
Typ MZ	mit großem Oberteil						
2-seitig Flansch	verstopfungsfrei	Flansch + Gewinde	Blattfeder	Gummidüse	Schleppschuh	Schleppschuh	Schlitzschuhdüse
150 mm / 6" € 169,00	150 mm / 6" € 389,00	133 mm / 5" € 205,00	900 lg. gerade € 35,00	95155 € 7,20	95089 € 16,90	90-35001 € 22,90	GFZUSG900100 € 39,90
200 mm / 8" € 429,00		150 mm / 6" € 249,00	860 lg. gebogen € 49,50				

Hebelgarnitur für Flanschschieber			Stopfbuchsenmutter	Hydraulikzylinder f. Schieber	
Standard	schwere Ausführung	R / L	mit Schmiernippel	einfachwirkend	doppelwirkend
					
6" € 24,90	4" - 6" € 29,90	4" - 6" € 34,50	6" € 6,90	6" € 149,00	6" € 139,00
8" € 31,50	8" € 34,90	8" € 54,90	8" € 8,90	8" € 189,00	8" € 139,00

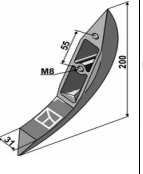
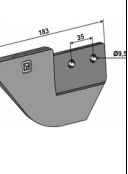
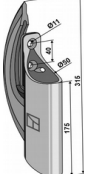
MZ Platten - Flanschschieber verstopfungsfrei mit Edelstahlplatte				Dreiwegehahn	Drehflansch
	mit Hydraulikzylinder doppelwirkend		mit Pneumatikzylinder doppelwirkend		
6" € 499,00	6" € 599,00	6" € 795,00	6" € 945,00	4" € 539,00	6" € 309,00
8" € 649,00	8" € 749,00	10" € 1199,00	10" € 1399,00	5" € 595,00	8" € 359,00

PVC-Rohr	Halter	T-Stück	Winkel 45°	Winkel 90°	Bundbuchse	Rundflansch
5 mtr. / 10 bar mit einer Klebemuffe	für PVC-Rohr	3 x Klebemuffe	2 x Klebemuffe	2 x Klebemuffe	für Rundflansch	verzinkt für Bundbuchse
						
160 mm € 175,00	160 mm € 17,50	160 mm € 56,00	160 mm € 35,90	160 mm € 49,50	160 mm € 29,50	160 mm € 39,90
200 mm € 259,00	200 mm € 21,90	200 mm € 125,90	200 mm € 63,90	200 mm € 69,00	200 mm € 42,90	200 mm € 45,90

### Kompressor für Güllewagen Battioni



Modell	Schlauchanschluß	€
MEC 6500	60 mm	1495,00
MEC 8000	60 mm	1595,00
MEC 8000	80 mm	1595,00
MEC 11000	80 mm	2095,00
MEC 13500	100 mm	2390,00

540 UPM

### Sicherheitsventil MZ mit Schlauchanschluß



1 1/4" Gewinde	€ 42,50
1 1/2" Gewinde	€ 45,90
2" Gewinde	€ 50,90

### Syphon-Abscheider mit Kunststoffgehäuse





60 Ø Schlauchanschluß	€ 139,50
80 Ø Schlauchanschluß	€ 178,00

### Ersatzglas für Abscheider

passend für MZ 60 Ø und 80 Ø € 21,90

### Schauglas mit Gewinde 2" € 2,90



Tangit-Reiniger für PVC	Tangit-Kleber für PVC
	
125 gr. € 16,50	250 gr. € 19,90
1000 gr. € 26,50	1000 gr. € 48,50

### Manometer



1/4" Gewinde Anschluß unten	
63 Ø Anzeige -1/+3,0 bar	€ 14,50
63 Ø Anzeige -1/+3,0 bar mit Glycerin gefüllt	€ 16,90
1/2" Gewinde Anschluß unten	
100 Ø Anzeige -1/+3,0 bar	€ 22,50

### Lamellen aus Hartgewebe



für Kompressor	Abmessung	€
MEC 4000	300x41,0x7 mm	12,50
MEC 5000	300x46,5x6 mm	12,90
MEC 6500	370x46,5x6 mm	13,90
MEC 8000	450x46,5x6 mm	16,50

### Vacupress Flex Schlauch für Schleppschlauch – Verteiler

mit verzinkter Stahlspirale – innen und außen glatt



	Druck	Biegeradius		€
100 mm x 8 mm	10 bar	300 mm	per mtr.	43,00
127 mm x 9 mm	7 bar	370 mm	per mtr.	69,50
152 mm x 9 mm	5 bar	480 mm	per mtr.	85,00
200 mm x 11 mm	3 bar	650 mm	per mtr.	179,00

# Gülle-Zubehör

## Spiralschlauch für Güllewagen



			PVC	Gummi
25 Ø	p/mtr.	€	3,40	
30 Ø	p/mtr.	€	4,40	
32 Ø	p/mtr.	€	3,90	
35 x 2,7	p/mtr.	€	4,80	
38 x 3,7	p/mtr.	€	6,50 (Schleppschlauch)	
40 x 3,9	p/mtr.	€	6,90 (Schleppschlauch)	
50 x 4,1	p/mtr.	€	10,50 (Schleppschlauch)	
60 Ø	p/mtr.	€		27,50
70 Ø	p/mtr.	€		45,00
76 Ø	p/mtr.	€	18,90	37,90
80 Ø	p/mtr.	€		39,00
90 Ø	p/mtr.	€	27,00	
100 Ø	p/mtr.	€	29,00	48,00
110 Ø	p/mtr.	€	34,50	51,00
120 Ø	p/mtr.	€		58,00
125 Ø	p/mtr.	€	39,00	61,00
133 Ø	2 mtr.	€	92,00	134,00
133 Ø	3 mtr.	€	138,00	199,00
150 Ø	2 mtr.	€	91,00	154,00
150 Ø	3 mtr.	€	136,00	230,00
150 Ø	4 mtr.	€	182,00	306,00
160 Ø	2 mtr.	€	119,00	176,00
160 Ø	3 mtr.	€	178,50	264,00
200 Ø	2 mtr.	€	189,00	230,00
Alle Größen bis 20 mtr. ( 50 mtr.) lieferbar !				

## Schlauchklemmen

stabile Ausführung  
mit Gewindestange



verzinkt			
32- 35 mm		€	1,30
36- 39 mm		€	1,30
40- 43 mm		€	1,40
43- 47 mm		€	1,70
48- 51 mm		€	1,70
52- 55 mm		€	1,70
56- 59 mm		€	1,70
60- 63 mm		€	1,80
64- 67 mm		€	2,20
68- 73 mm	60 Ø / 22 br.	€	2,30
74- 79 mm	65 Ø / 24 br.	€	2,50
80- 85 mm	70 Ø / 24 br.	€	2,50
86- 91 mm	75 Ø / 24 br.	€	2,80
92- 97 mm	80 Ø / 24 br.	€	2,90
98-103 mm	85 Ø / 24 br.	€	3,00
104-112 mm	90 Ø / 24 br.	€	3,00
113-121 mm	100 Ø / 24 br.	€	3,30
122-130 mm	110 Ø / 24 br.	€	3,30
131-139 mm	120 Ø / 26 br.	€	4,20
140-148 mm	125 Ø / 26 br.	€	4,30
149-161 mm	133 Ø / 26 br.	€	4,90
162-174 mm	150 Ø / 26 br.	€	4,70
162-174 mm	aus V2A	€	10,90
175-187 mm	159 Ø / 26 br.	€	5,60
175-187 mm	aus V2A	€	13,50
201-213 mm	/ 26 br.	€	5,80
214-226 mm	200 Ø / 26 br.	€	6,00
214-226 mm	aus V2A	€	15,50

## Saugrohr für Güllewagen mit Schlauchtülle gerade



100 Ø	3 mtr.	€	85,00
125 Ø	3 mtr.	€	149,00
133 Ø	2 mtr.	€	99,00
133 Ø	3 mtr.	€	149,00
133 Ø	4 mtr.	€	179,00
150 Ø	2 mtr.	€	105,00
150 Ø	3 mtr.	€	139,00
150 Ø	4 mtr.	€	179,00
160 Ø	3 mtr.	€	169,00
160 Ø	4 mtr.	€	209,00

## Saugrohr für Güllewagen mit Schlauchtülle 45° Bogen



125 Ø	3 mtr.	€	135,00
133 Ø	3 mtr.	€	155,00
133 Ø	4 mtr.	€	185,00
150 Ø	3 mtr.	€	149,00
150 Ø	4 mtr.	€	175,00
150 Ø	5 mtr.	€	215,00
160 Ø	3 mtr.	€	195,00
160 Ø	4 mtr.	€	239,00

## Saugrohr System Perrot mit 45° Bogen und VT-Kupplung



150 Ø	4 mtr.	System Perrot	€ 369,00
150 Ø	5 mtr.	System Perrot	€ 429,00
200 Ø	4 mtr.	System Perrot	€ 395,00

## Bau- Industrieschlauch 10 bar



Synthetikschauch weiß komplett m. Kupplungen

"C"-Schlauch 52 mm			
10 mtr.	€ 52,50	20 mtr.	€ 89,50
"B"-Schlauch 76 mm			
10 mtr.	€ 94,00	20 mtr.	€ 139,00

## Saugrohr ital. System mit 45° Bogen und MT-Kupplung



150 Ø	4 mtr.	ital. System	€ 215,00
150 Ø	5 mtr.	ital. System	€ 259,00
200 Ø	4 mtr.	ital. System	€ 369,00
200 Ø	5 mtr.	ital. System	€ 399,00

## PVC-Flachschauch blau 8 bar mit Polyesterfaden Verstärkung

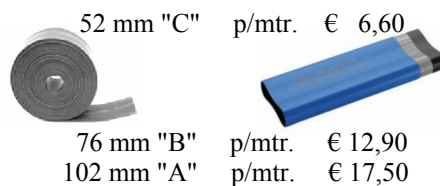

52 mm "C" p/mtr. € 6,60

76 mm "B" p/mtr. € 12,90  
102 mm "A" p/mtr. € 17,50

## Saugrohr ital. System mit 45° Bogen und VT-Kupplung



150 Ø	4 mtr.	ital. System	€ 209,00
150 Ø	5 mtr.	ital. System	€ 249,00
200 Ø	4 mtr.	ital. System	€ 345,00
200 Ø	5 mtr.	ital. System	€ 399,00

## Kupplungen System Bauer



MT-Kupplung		VT-Kupplung	
100 mm	€ 20,90	100 mm	€ 47,90
133 mm	€ 33,90	133 mm	€ 72,50
150 mm	€ 37,90	150 mm	€ 83,50

## Industrie-Beregnungsschlauch schwarz

Preis per mtr.



52 mm	76 mm	102 mm	125 mm
17 bar	15 bar	13 bar	10 bar
€ 11,50	€ 14,90	€ 23,50	€ 34,00

## Spaltenlanze 2mtr. lang

Rechteckrohr 80/20 mm mit Bogen 90°  
kpl. mit Feuerwehrrkupplung "B"

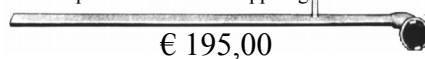

€ 195,00

## Strahlrohr kpl. mit Kupplung

"C"- Kupplung € 69,90  
"B"- Kupplung € 139,00



## Feuerwehrrkupplung "Storz" Innen- oder Außengewinde

"C" 2" Gewinde	€ 7,50
"C" 2 1/2" Gewinde	€ 15,90
"B" 2 1/2" Gewinde	€ 10,50
"B" 3" Gewinde	€ 10,50
"A" 4" Gewinde	€ 16,90



## mit Schlauchtülle

"C" 38mm Tülle	€ 7,50
"C" 52mm Tülle	€ 7,50
"B" 75mm Tülle	€ 10,80
"A" 100mm Tülle	€ 26,50



## Übergangsstück

Storz "B" - "C"	€ 18,50
Storz "A" - "B"	€ 30,50
Storz "C" - Geka	€ 9,50



## Blindkupplung

Storz "C"	€ 8,50
Storz "B"	€ 12,50
Storz "A"	€ 21,50



## Tankwagenkupplung

Messing 3 Zoll Innengewinde	
Kurvenstück VK 80	€ 39,90
Kronenstück TWK 80	€ 29,50
Spannring TWM 80	€ 44,90









# Gülle-Zubehör ital. System

Mutterteil italienisches System		
		
Öffnung A	Ø Schlauch	
Öffnung A	Schlauchanschluß Ø	€
132 mm	100 Ø	19,50
151 mm	125 Ø	24,50
151 mm	133 Ø	28,90
180 mm	150 Ø	29,90
180 mm	160 Ø	33,50
245 mm	200 Ø	83,90



Vaterteil italienisches System		
		
Öffnung A	Ø Schlauch	
Öffnung A	Schlauchanschluß Ø	€
100 mm	100 Ø	18,50
125 mm	125 Ø	25,50
125 mm	133 Ø	26,50
150 mm	150 Ø	31,50
150 mm	160 Ø	33,50
200 mm	200 Ø	76,90

Feuerwehr-Übergangsstücke mit 2 1/2 " Außengewinde und Storz 75 B Kupplung		
ital. System		
Größe	VT-Kupplung	MT-Kupplung
100 mm	€ 44,50	€ 44,50
133 mm	€ 46,90	€ 46,90
150 mm	€ 54,90	€ 54,90

Dichtungen		Flanschkupplung ital. System		Saugschlauch - Schnellkuppler	
ital. System	ital. System	Vaterteil	Mutterteil	ital. System	ital. System
					
100 mm / 4" € 1,20 133 mm / 5" € 2,20	150 mm / 6" € 2,80 200 mm / 8" € 5,40	100 mm / 4" € 37,90 133 mm / 5" € 42,90 150 mm / 6" € 52,50 200 mm / 8" € 112,00	100 mm / 4" € 44,50 133 mm / 5" € 48,50 150 mm / 6" € 55,50 200 mm / 8" € 137,00	mit Entlüftungsnippel Lochabstand 150 mm 150 mm 6" € 289,00	mit Entlüftungsnippel kurze Ausführung 150 mm 6" € 339,00



Bogen mit MT und VT Kupplung		Gewindekupplung ital. System		Perfekt-Verteiler ital. System	
ital. System	ital. System	Vaterteil	Mutterteil	VT-Kupplung	MT-Kupplung
					
Bogen 45 Grad verzinkt 150 mm / 6" € 82,50 200 mm / 8" € 185,00	Bogen 90 Grad verzinkt 150 mm / 6" € 84,50 200 mm / 8" € 189,00	mit Außengewinde 133 mm / 5" € 28,90 150 mm / 6" € 39,90	mit Außengewinde 133 mm / 5" € 31,50 150 mm / 6" € 39,50	150 mm / 6" € 159,00	150 mm / 6" € 179,00



Bogen ital. System		Blinddeckel ital. System		Umkehrstück ital. System	
mit Flansch + Vaterteil	mit Flansch + Mutterteil	Vaterteil	Mutterteil	2 x Vaterteil	2 x Mutterteil
					
133 mm / 5" € 72,00 150 mm / 6" € 105,00	133 mm / 5" € 75,00 150 mm / 6" € 105,00	150 mm / 6" € 24,50 200 mm / 8" € 59,90	150 mm / 6" € 26,50 200 mm / 8" € 72,50	150 mm / 6" € 59,90 200 mm / 8" € 142,00	150 mm / 6" € 60,50 200 mm / 8" € 149,00

Flanschplatte	Dichtung	Blindflansch	Blindflansch	Flanschtülle	Flansch mit
schwarz		schwarz	verzinkt	verzinkt	Außengewinde
					
150 mm 4"- 6" € 11,50 200 mm 8" € 17,50	150 mm 4"- 6" € 2,50 200 mm 8" € 3,40	150 mm 4"- 6" € 12,90 200 mm 8" € 18,50	150 mm 4"- 6" € 23,90 200 mm 8" € 38,90	100 mm 4" € 38,90 150 mm 6" € 39,90 159 mm 6" € 39,90 200 mm 8" € 67,50	150 mm 5" Gewinde € 51,50 150 mm 6" Gewinde € 57,50







Rohrbogen 2 x Flanschplatte			Handgriff	Rohrnippel schwarz		Kompresse
verzinkt 17 Grad für Schnellkuppler	verzinkt 45 Grad	verzinkt 90 Grad	für Gülleschlauch	zum anschweißen		220 Ø x 470 mm lang
						
150 mm / 6" € 37,50 200 mm / 8" € 49,90	150 mm / 6" € 99,00 200 mm / 8" € 179,00	150 mm / 6" € 99,00 200 mm / 8" € 179,00	150 mm 6" € 22,90 200 mm 8" € 23,90	2" € 14,50 2 1/2" € 16,20 3" € 17,50	4" € 21,50 5" € 21,50 6" € 23,90	aus Polyurethan € 695,00 aus Gummi € 419,00



# Gülle-Zubehör passend für Perrot





Mutterteil Original Perrot		
 		
Öffnung A	Ø Schlauch	
Öffnung A	Schlauchanschluß Ø	€
145 mm	100 Ø	39,50
145 mm	110 Ø	42,90
171 mm	125 Ø	56,90
171 mm	133 Ø	63,90
203 mm	150 Ø	59,90
203 mm	160 Ø	68,90
287 mm	200 Ø	199,00

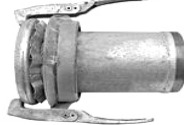

Vaterteil Original Perrot		
 		
Öffnung A	Ø Schlauch	
Öffnung A	Schlauchanschluß Ø	€
108 mm	100 Ø	16,50
108 mm	110 Ø	16,90
133 mm	125 Ø	20,90
133 mm	133 Ø	25,50
159 mm	150 Ø	23,50
159 mm	160 Ø	29,90
216 mm	200 Ø	89,00

Feuerwehr-Übergangsstücke mit 2 1/2 " Außengewinde und Storz 75 B Kupplung		
Perrot System		
	<b>Größe</b>	<b>VT-Kupplung</b>
108 mm	€ 37,50	€ 77,50
133 mm	€ 52,00	€ 119,00
150 mm	€ 53,90	€ 119,00

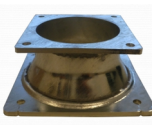
Dichtungen		Flanschkupplung Original Perrot			
System Perrot	System Perrot	Vaterteil	Vaterteil mit Abgang	Mutterteil kurze Ausf.	Mutterteil lange Ausf.
					
70 mm € 0,95 89 mm / 3" € 1,30	108 mm / 4" € 2,90 133 mm / 5" € 3,30 159 mm / 6" € 3,50 200 mm / 8" € 9,50	108 mm / 4" € 40,90 133 mm / 5" € 45,90 159 mm / 6" € 52,50 200 mm / 8" € 119,00	150 mm / 2" € 119,00 150 mm / 2 1/2" € 139,00 200 mm / 2" € 148,50 200 mm / 2 1/2" € 149,50	4" / 150mm lang € 73,90 5" / 150mm lang € 87,50 6" / 150mm lang € 92,50 8" / 200mm lang € 256,00	4" / 360mm lang € 74,90 5" / 360mm lang € 89,90 6" / 360mm lang € 114,90 8" / 400mm lang € 279,00

Bogen mit MT und VT Kupplung		Gewindekupplung Original Perrot		Saugschlauch - Schnellkuppler	
System Perrot	System Perrot	Vaterteil	Mutterteil	System Perrot	System Perrot
45 Grad Bogen	90 Grad Bogen				
159 mm / 6" € 145,00	108 mm / 4" € 75,00 159 mm / 6" € 129,00 200 mm / 8" € 409,00	108 mm / 4" € 26,50 133 mm / 5" € 40,90 159 mm / 6" € 45,50	108 mm / 4" € 56,50 133 mm / 5" € 83,90 159 mm / 6" € 96,50	Lochabstand 150 mm 150 mm 6" € 159,00	Lochabstand 180 mm 200 mm 8" € 295,00

Bogen System Perrot 90 Grad			Reduzierflansch	Umkehrstück System Perrot	
mit Flansch + Vaterteil	mit Flansch + Mutterteil	mit Tülle + Vaterteil	verzinkt	2 x Vaterteil	2 x Mutterteil
					
150 mm / 6" € 89,00 200 mm / 8" € 299,00	150 mm / 6" € 175,00 200 mm / 8" € 498,00	150 mm / 6" € 75,00	Flansch 8" - Flansch 6" € 79,00	150 mm / 6" € 48,50 200 mm / 8" € 139,00	150 mm / 6" € 169,00 200 mm / 8" € 335,00

Blindeckel System Perrot		T-Stück verzinkt		Zwischenstück verzinkt	
Vaterteil	Mutterteil	3 x Flansch	mit Reduzierung	150mm lang	300mm lang mit Abgang 2"
					
150 mm / 6" € 27,90 200 mm / 8" € 74,90	150 mm / 6" € 73,50 200 mm / 8" € 179,00	150 mm 4"-6" € 105,00 200 mm 8" € 159,00	2 x 8" + 1 x 6" Flansch € 149,00	150 mm 6" € 57,00 200 mm 8" € 115,00	150 mm 6" € 79,00 200 mm 8" € 142,00

Komprese			Flanschstutzen		Andocktrichter		Reduzierkupplung	
								
150 mm lang					<b>Aktion</b>		<b>Org. Zunhammer</b>	
Ø	Polyurethan	Gummi	für Andocktrichter 6" € 62,50	6" € 269,00	6" € 299,00	VT-Kupplung 200 mm	MT-Kupplung 200 mm	
150	€ 139,00	€ 69,00	für Andocktrichter 8" € 75,00	8" € 299,00	8" € 329,00	MT-Kupplung 150 mm	VT-Kupplung 150 mm	
200	€ 199,00	€ 89,00	für Andocktrichter 10" € 239,00	10" € 499,00	10" € 499,00	€ 166,00	€ 369,00	

# Wasserinstallation und Zubehör

Verschraubung		Verschraubung		Rohrnippel verzinkt		Winkel verz.		Winkel verz.	
1/2" verzinkt € 3,95	3/4" verzinkt € 4,20	1/2" verzinkt € 4,60	3/4" verzinkt € 5,20	1/2" 40mm € 1,10	1/2" 60mm € 1,20	3/4" 40mm € 1,20	3/4" 60mm € 1,30	1/2" 45 Grad € 3,40	1/2" 90 Grad € 1,90
Dichtung 1/2" € 0,60	Dichtung 3/4" € 0,70	Dichtung 1/2" € 0,60	Dichtung 3/4" € 0,70	1/2" 100mm € 1,30	1/2" 150mm € 1,80	3/4" 100mm € 1,80	3/4" 150mm € 2,40	3/4" 45 Grad € 3,95	3/4" 90 Grad € 1,90
2 x Innengewinde	Außen- u. Innengewinde	2 x Innengewinde	2 x Innengewinde	2 x Außengewinde	2 x Außengewinde	2 x Außengewinde	2 x Außengewinde	2 x Innengewinde	Innen- und Außengewinde

Anschlüsse für IBC-Container		Muffe		Reduziermuffe		T-Stück		Hanfzopf	
		mit Panzerschlauch 70 cm Übergang 1/2" und 3/4"		1/2" € 1,30	3/4" - 1/2" € 2,80	1/2" verzinkt € 1,80		200 gr. € 3,20	
Wasserhahn 3/4" #221982 € 8,90			mit Panzerschlauch 70 cm Übergang 1/2" und 3/4" #221980 € 30,50	3/4" € 1,80	1" - 1/2" € 3,20	3/4" verzinkt € 2,50	3/4" - 1/2" € 2,50	<b>Neo-Fermit</b>	150 gr. € 8,40
		2 x Innengewinde		2 x Innengewinde		3 x Innengewinde			

Kugelhahn mit Schlauchtülle		Muffen-Kugelhahn		Kugelhahn		Doppelnippel		Stopfen		Kappe	
mit Schlauchtülle		2 x Innengewinde		Innen- und Außengewinde		mit Sechskant		Außengewinde		Innengewinde	
1/2" € 7,90	3/4" € 11,50	1/2" € 6,40	3/4" € 8,90	1/2" € 5,90	3/4" € 7,90	1/2" € 1,20	3/4" € 1,60	1/2" € 1,10	3/4" € 1,20	1/2" € 1,40	3/4" € 1,70
1" € 12,90		1" € 13,90	1 1/4" € 24,90	1" € 2,90	1 1/4" € 4,70						
		1 1/2" € 32,50	2" € 46,50	1 1/2" € 4,70	1 1/2" € 4,70						

Schnellkupplung mit Schlauchanschluß		Gewindestück mit Innengewinde		Gewindestück mit Außengewinde		Dichtung		Blindkappe		Spritzdüse	
mit Schlauchanschluß		mit Innengewinde		mit Außengewinde		lose		Verschluß		mit Schnellkupplung	
1/2" € 2,80	3/4" € 2,95	1/2" € 2,60	3/4" € 2,70	1/2" € 2,60	3/4" € 2,70	€ 0,40		€ 2,80		1/2" € 7,80	3/4" € 10,50
1" € 3,80	1 1/4" € 3,95	1" € 2,90	1 1/4" € 4,70	1" € 2,90	1 1/4" € 4,70					1" € 14,90	
1 1/2" € 5,70		1 1/2" € 4,95		1 1/2" € 4,70							

### Kupplungen Stecksystem

Stecker Messing		€
		2,20
		2,20
		2,20
		2,50
Kupplung Messing		€
		4,90
		4,90
Kupplung Messing mit Wasserstop		€
		6,90
		8,50

**Spritzdüse verstellbar 1/2" € 4,50**

### Schlauchschellen

	verzinkt	V2A
<b>9 mm breit</b>		
8- 16 mm 3/8"	0,70	1,00
12- 20 mm 1/2"	0,70	1,00
16- 27 mm 3/4"	0,80	1,00
20- 32 mm 1"	0,80	1,10
<b>12 mm breit</b>		
25- 40 mm 1 1/4"	1,20	1,30
32- 50 mm	1,20	1,40
40- 60 mm	1,40	1,80
50- 70 mm	1,60	1,80
60- 80 mm	1,60	1,80
70- 90 mm	1,80	1,90
80-100 mm	1,80	1,90
100-120 mm	2,00	2,10

### Wasserschlauch

Hochdruck-Qualitätsschlauch für Industrie, Gartenbau  
sehr flexibel kältefest- alterungs- u. witterungsbeständig

Größe	Rollenslänge	Betriebsdruck	p/mtr. €	b. Rolle €
-15° bis +60°				
1/2" PVC gelb	50 Meter	15 bar	1,90	1,80
3/4" PVC gelb	50 Meter	15 bar	3,20	2,95
1" PVC gelb	50 Meter	12 bar	5,60	5,10
-40° bis +95°				
1/2" EPDM	40 Meter	20 bar	4,70	4,30
3/4" EPDM	40 Meter	20 bar	6,80	6,20
1" EPDM	40 Meter	20 bar	10,90	9,90

### Kupplungen System Kamlock

aus Polypropylene	Vaterteil	€
	1 1/4" 32 mm	5,50
	1 1/2" 38 mm	5,50
	2" 51 mm	6,50
Mutterteil		€
	1 1/4" 32 mm	15,90
	1 1/2" 38 mm	17,50
	2" 51 mm	19,90

### Kaltreiniger

für starke, hartnäckige und ölige Verschmutzungen

5 ltr. Kanister € 25,90

### Waschgeräteschlauch pass. f. Kärcher

mit Gummiknickschutz

	2-seitig M22 Überwurfmutter	mit Nippel 11 mm
Länge	210 bar	400 bar
10 mtr.	€ 86,50	€ 95,00
15 mtr.	€ 115,00	€ 139,00
20 mtr.	€ 129,00	€ 175,00
Adapter mit Nippel 10 mm € 26,90		

# Siloentnahme / Zubehör für Dungstreuer und Ladewagen

**Silosäcke 190 gr/m<sup>2</sup> grün**  
mit Griff und Verschußdraht



Größe	ab 50 St.	ab 100 St.
100 x 25 cm	€ 1,25	€ 1,05
120 x 27 cm	€ 1,35	€ 0,95
Drillapparat für Verschußdraht	€ 13,50	

**Silosäcke 190 gr/m<sup>2</sup> grün**  
mit Griff und Zugband



Größe	ab 50 St.	ab 100 St.
100 x 25 cm	€ 1,30	€ 1,20
120 x 27 cm	€ 1,40	€ 1,30

**Silo-Entnahmezinken**  
gekröpft



passend für:	Art.-Nr.	Länge / Kröpfung Gewinde	€
Alö	18834	820/60/M24	47,50
Alö	18921	920/60/M24	39,50
Baas	18817	815/60/M20	49,50
Bressel	18830	820/56/M22	51,50
Fella	18920	920/43/M27	72,00
Fella	18953	950/30/M22	59,00
Fella	18958	950/43/M22	56,50
Kverneland	18825	810/53/M20	49,50
Kuhn	18852	880/40/M22	49,00
Kuhn	181006	1000/40/M22	59,50
Lengerich	18911	920/43/M22	48,90
Stoll	18823	815/48/M20	51,50
Stoll	18837	820/- /M28	66,90
Stoll	18839	815/58/M24	62,50
Strautmann	18814	800/60/M20	39,50
Strautmann	M20	930/35 oder 60	56,00
Strautmann	M20	1000/35 oder 60	58,00
Strautmann	18843	840/45/M27	64,00
Trioliet	18851	880/50/M22	47,50
Vicon	18851	880/50/M22	47,50
Weidemann	18828	810/40/M22	49,50

**Siloschutzgitter 240 gr./m<sup>2</sup>**  
4 to Reißfestigkeit je m<sup>2</sup>



Größe	je Stück	ab 5 Stück
5 x 6 mtr.	€ 48,00	€ 45,00
5 x 7 mtr.	€ 55,00	€ 52,00
5 x 8 mtr.	€ 62,50	€ 59,50
5 x 9 mtr.	€ 71,00	€ 68,00
5 x 10 mtr.	€ 79,50	€ 74,50
5 x 12 mtr.	€ 95,00	€ 89,90
6 x 10 mtr.	€ 95,00	€ 89,90
10 x 12 mtr.	€ 189,00	€ 179,00

**Messer für Siloblocksneider**

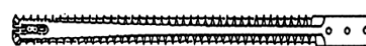

Doppelmesser passend für: €

Fella 860 mm 418946 1 Satz 475,00

**Reparaturband für Silagefolie**



75mm x 20 mtr.	schwarz	€ 11,90
100mm x 10 mtr.	schwarz	€ 4,50
100mm x 10 mtr.	grün	€ 4,50
100mm x 25 mtr.	weiß	€ 9,50

**Hochfeste Dungstreuerketten**

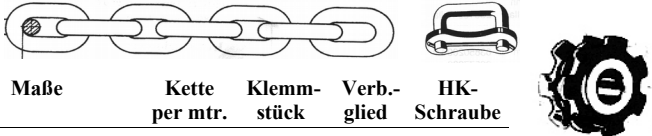

Maße	Kette per mtr.	Klemmstück	Verb.-glied	HK-Schraube
8x24	8,0 to 12,90	1,70	4,70	1,25
8x31	8,0 to 8,90	2,50	5,30	1,20
9x31	9,0 to 10,90	1,95	5,30	1,50
10x31	10,0 to 13,90	2,30	5,50	1,50
10x35	10,0 to 16,50	2,70	5,90	1,50
11x31	11,5 to 16,90	1,95	5,50	1,70
11x35	11,5 to 17,90	2,90	5,90	1,60
13x36	15,2 to 24,90		6,90	
14x50	19,0 to 29,50		24,90	

**Kratzbodenleisten - Streuflügel**

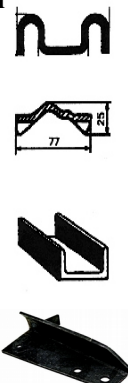

passend für	Länge	Bohrung	€
Bergmann M-Profil	1640 mm	10,5 Ø	34,50
Kemper Spez.-Profil gerade	1560 mm	10,5 Ø	42,50
Kemper U-Profil 25x50 M	1780 mm	13,0 Ø	42,50
Krone M-Profil gewölbt	1450 mm	10,5 Ø	33,50
Krone M-Profil gewölbt	1650 mm	10,5 Ø	37,50
Mengele U-Profil 40x20 P	1600 mm	10,5 Ø	34,90
Mengele U-Profil 25x50 F	1720 mm	10,5 Ø	42,50
Strautmann U-Profil 30x60 F	775 mm	12,0 Ø	38,00
Tebbe mit Rübüg Glied HF78	733 mm		46,50
Welger Spez.-Profil gew.	1580 mm	10,5 Ø	38,50
Welger Spez.-Profil gew.	820 mm	12,0 Ø	33,50

Streuflügel Bergmann 09570052/53 41,50

**Einfach - Rollenketten**



Tagex	Teilung mm	innere Breite	Rolle Ø mm	Preis per mtr.	Glied gerade	Glied gekröpft
1/2" x 3/16"	12,70	4,88	7,75	€ 9,80	€ 1,60	€ 4,40
1/2" x 1/4"	12,70	6,40	7,75	€ 10,00	€ 1,30	€ 2,30
1/2" x 5/16"	12,70	7,75	8,50	€ 10,30	€ 1,20	€ 1,70
5/8" x 3/8" 10B	15,88	9,65	10,15	€ 10,80	€ 1,30	€ 2,00
5/8" x 3/8" V	15,88	9,65	10,15	€ 13,80	€ 1,70	€ 3,20
3/4" x 7/16" 12B	19,05	11,70	12,07	€ 13,50	€ 1,40	€ 2,50
3/4" x 7/16" V	19,05	11,70	12,07	€ 22,50	€ 2,20	€ 3,50
3/4" x 1/2"	19,05	12,60	11,91	€ 14,40	€ 1,90	€ 3,10
3/4" x 1/2" V	19,05	12,60	11,91	€ 23,50	€ 2,20	€ 4,50
3/4" x 13,5mm	19,05	13,50	12,07	€ 27,90	€ 2,20	€ 3,30
1" x 1/2"	25,40	12,70	12,70	€ 63,50	€ 2,90	€ 5,20
1" x 1/2"	25,40	12,70	15,90	€ 56,90	€ 2,90	€ 5,30
1" x 5/8" ASA80	25,40	15,75	15,90	€ 49,50		
1" x 17mm/16B1	25,40	17,02	15,90	€ 25,50	€ 2,70	€ 3,90
1 1/4" x 3/4" 20B	31,75	19,60	19,05	€ 38,50	€ 4,00	€ 7,20
1 1/4" x 3/4" ASA100	31,75	18,90	19,05	€ 79,00	Laschen 4,9 mm	
1 1/2" x 1" 24B1	38,10	25,40	25,40	€ 68,00	€ 5,10	€ 9,80
1 1/2" x 1" ASA120	38,10	25,22	22,23	€ 136,90	Laschen 5,7 mm	



**Duplex - Rollenketten**

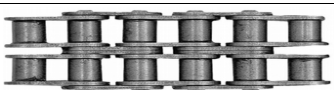

	Teilung mm	innere Breite	Rolle Ø	Preis per mtr.	Glied gerade	Glied gekröpft
3/4" x 1/2"	19,05	12,70	11,91	€ 35,50	€ 4,95	€ 5,40
1" x 17	25,40	17,02	15,90	€ 59,90	€ 5,90	€ 9,90

**Stahlgelenkkette Org. Kohlswa**

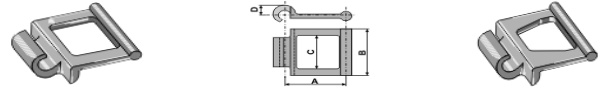

Art.Nr	Teilung A	Breite B	Bruchlast	Glieder p. mtr.	je Glied
69-074	60,6 mm	65,0 mm	65000 N	16,5	€ 6,80
69-078	67,1 mm	70,0 mm	50000 N	pass. f. JF / 14,9	€ 6,20
69-103	78,5 mm	87,0 mm	75000 N	12,7	€ 12,50

**Original Rübüg Gliederkette gesenkgeschmiedet**

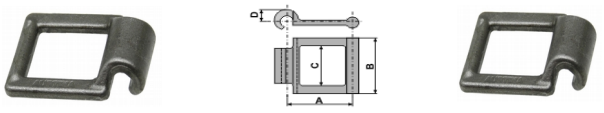

Art.Nr	Teilung A	Breite B	Bruchlast	Glieder p. mtr.	je Glied
HF 59	59,0 mm	49,0 mm	60000 N	16,9	€ 7,90
HF 67	67,0 mm	62,0 mm	80000 N	pass. f. JF / 14,9	€ 12,90
HF 78	78,5 mm	82,0 mm	125000 N	12,7	€ 19,80